



SolConeX Wall-Mounted Socket, 16 A

Series 8570/11

Contents

1	General Information	2
1.1	Manufacturer	2
1.2	Information Regarding the Operating Instructions	3
1.3	Further Documents	3
1.4	Conformity with Standards and Regulations	3
2	Explanation of the Symbols	3
2.1	Symbols in these Operating Instructions	3
2.2	Warning Notes	4
2.3	Symbols on the Device or in the Circuit Diagrams	4
3	Safety Notes	5
3.1	Operating Instructions Storage	5
3.2	Safe Use	5
3.3	Modifications and Alterations	5
4	Function and Device Design	5
4.1	Function	5
5	Technical Data	6
6	Transport and Storage	7
7	Mounting and Installation	8
7.1	Dimensions / Fastening Dimensions	8
7.2	Mounting / Dismounting, Operating Position	10
7.3	Installation	11
8	Commissioning	13
9	Operation	13
10	Maintenance and Repair	14
10.1	Maintenance	14
10.2	Maintenance	14
10.3	Repair	15
10.4	Returning the Device	15
11	Cleaning	15
12	Disposal	15
13	Accessories and Spare Parts	15

1 General Information

1.1 Manufacturer

R. STAHL Schaltgeräte GmbH
 Am Bahnhof 30
 74638 Waldenburg
 Germany

Phone: +49 7942 943-0
 Fax: +49 7942 943-4333
 Internet: www.stahl-ex.com



1.2 Information Regarding the Operating Instructions

ID-No.:	150646 / 8570601300
Publication Code:	2016-04-21-BA00-III-en-06
Hardware version:	n/a
Software version:	n/a

The original instructions are the English edition.
They are legally binding in all legal affairs.

1.3 Further Documents

- Data sheet Plug and socket devices SolConeX & CES
- For further languages, see www.stahl-ex.com.

1.4 Conformity with Standards and Regulations

The equipment conforms to the following standards:





- Directive 94/9/EC
- IEC 60079-0
- IEC 60079-1
- IEC 60079-7
- IEC 60079-11
- IEC 60309
- IEC 61241-0
- IEC 61241-1

Additional standards:

See certificates and EC Declaration of Conformity: www.stahl-ex.com.

2 Explanation of the Symbols



2.1 Symbols in these Operating Instructions

Symbol	Meaning
	Tips and recommendations on the use of the device
	General danger
	Danger due to explosive atmosphere
	Danger due to energised parts





2.2 Warning Notes

Warning notes must be observed under all circumstances, in order to minimize the risk due to construction and operation. The warning notes have the following structure:

- Signalling word: DANGER, WARNING, CAUTION, NOTICE
- Type and source of danger/damage
- Consequences of danger
- Taking countermeasures to avoid the danger/damage

	DANGER
	Danger for persons Non-compliance with the instruction results in severe or fatal injuries to persons.
	WARNING
	Danger for persons Non-compliance with the instruction can result in severe or fatal injuries to persons.
	CAUTION
	Danger for persons Non-compliance with the instruction can result in minor or light injuries to persons.
NOTICE	
Avoiding material damage Non-compliance with the instruction can result in material damage to the device and/or its environment.	

2.3 Symbols on the Device or in the Circuit Diagrams

Symbol	Meaning
 <small>05594E00</small>	CE marking according to the current applicable directive.
 <small>02198E00</small>	According to marking, device approved for hazardous areas.
 <small>15649E00</small>	Input
 <small>15648E00</small>	Output

3 Safety Notes

3.1 Operating Instructions Storage

- Read the operating instructions carefully and store them at the mounting location of the device.
- Observe applicable documents and operating instructions of the devices to be connected.

3.2 Safe Use

- Read and observe the safety instructions in these operating instructions!
- Use the cable gland in accordance with its intended purpose only.
- We cannot be held liable for damage caused due to incorrect or unauthorized use or non-compliance with these operating instructions.
- Before installation and commissioning, make sure that the device is not damaged.
- Work on the cable gland (installation, maintenance, overhaul, repair) may only be carried out by appropriately authorized and trained personnel.
- During installation and operation observe the information (characteristic values and rated operating conditions) on the rating and data plates and the information plates located on the device containing the cable glands.
- Always consult with R. STAHL Schaltgeräte GmbH in case of operating conditions which deviate from the technical data.

3.3 Modifications and Alterations

	WARNING
	<p>Danger due to modifications and alterations to the device! Explosion protection is impaired!</p> <ul style="list-style-type: none"> • Do not modify or change the device. • No liability or warranty for damage resulting from modifications and alterations.

4 Function and Device Design

	WARNING
	<p>Danger due to improper use! Explosion protection is impaired!</p> <ul style="list-style-type: none"> • The device may only be used according to the operating conditions described in these operating instructions.

4.1 Function

The wall-mounting socket 8570/11 is an explosion-protected electric equipment. It connects portable and stationary electric equipment as well as electric lines and circuits in hazardous areas.

It is approved for use in hazardous areas of Zones 1, 2, 21 and 22.

5 Technical Data

Explosion Protection

Global (IECEx)

Gas and dust	IECEx PTB 05.0023 Ex db eb IIC T6 Gb Ex db eb [ia Ga] [ib] IIC T6 Gb Ex tb IIIC T80°C Db
--------------	---

Europe (ATEX)

Gas and dust	PTB 03 ATEX 1227 ⊕ II 2 G Ex db eb IIC T6 Gb ⊕ II 2 D Ex tb IIIC T80°C Db
Special version with intrinsically safe auxiliary contacts	⊕ II 2 (1) G Ex db eb [ia Ga] [ib] IIC T6 Gb

Certifications and certificates

Certificates	IECEx, ATEX, Brazil (INMETRO), China (China-Ex), India (PESO), Canada (CSA), Kazakhstan (TR), Korea (KCs), Russia (TR), Taiwan (ITRI), Ukraine (TR), USA (FM), Belarus (TR)
Ship approval	GL

Technical Data

Electrical data

Rated operational voltage	
Main contacts	max. 690 V AC / max. 110 V DC
Auxiliary contacts	max. 500 V AC / max. 110 V DC
Frequency	0 ... 60 Hz, others on request
Voltage tolerance	-10 ... +6 %
Rated operational current	
Main contacts	16 A
Auxiliary contacts	max. 6 A
Rated operational power	Main contacts: AC-3: 690 V, 16 A 4 kW: 220 V / 230 V / 240 V 7.5 kW: 380 V / 400 V / 415 V / 500 V 11 kW: 600 V / 690 V DC-1: 110 V, 16 A Auxiliary contacts: AC-15: 500 V, max. 1250 VA AC-15: 230 V, max. 1380 VA AC-12: 500 V, max. 3000 VA DC-13: 110 V, 110 W

Technical Data

Back-up fuse	
without thermal protection	16 A gG
with thermal protection	35 A gG
Ambient conditions	
Ambient temperature	-30 ... +55 °C -50 °C on request (internal lubrication using silicone grease)
Mechanical data	
Number of poles	2 P + $\frac{1}{2}$, 3 P + $\frac{1}{2}$, 3 P + N + $\frac{1}{2}$
Auxiliary contacts	2 optional auxiliary contacts (ON - delayed, OFF - leading)
Switching handle	lockable in 0 and I position
Material	
Enclosure	polyamide, glass fibre reinforced
Degree of protection	IP66 acc. to IEC/EN 60529
Connection type	Screw-type terminals
Connection Terminals	
Main contacts	2 x 1.5 ... 6 mm ² single-wire 2 x 1.5 ... 4 mm ² finely stranded
Auxiliary contacts	2 x 0.5 ... 2.5 mm ² single wire/stranded copper
Weight	
	8570/11-3 1.12 kg
	8570/11-4 1.35 kg
	8570/11-5 1.45 kg
Service life	5000 switching cycles (electrical and mechanical)
Tightening torque	
	Terminal: 1.2 Nm Socket connection chamber cover max. 1.8 Nm
Cable entries	
Clamp size	7 ... 17 mm cable diameter
Cable gland	1 x M25 x 1.5 (positioning on the top or at the side, according to the order) optional: top max. 2 x M25 x 1.5; sealing plugs or metal entries are also available
Stopping plug	1 x M25 x 1.5

For further technical data, see www.stahl-ex.com.

6 Transport and Storage

- Transport and store the device only in the original packaging.
- Store the device in a dry place (no condensation) and vibration-free.
- Do not drop the device.

7 Mounting and Installation

7.1 Dimensions / Fastening Dimensions

Dimensional drawings (all dimensions in mm [inch]) – Subject to alterations

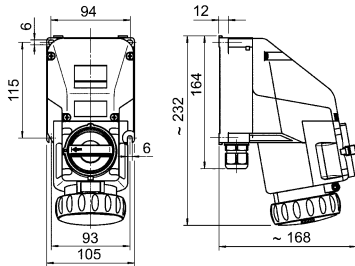

10338E00

8570/11-3..

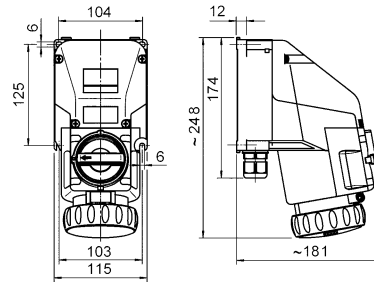

10333E00

8570/11-4.. and 8570/11-5..

Arrangement of the earth contact sleeve

Position: clock hour position, View: front side of the socket

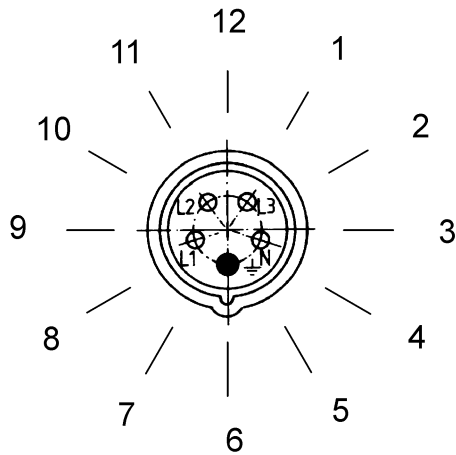

02395E00

Example: Clock hour position

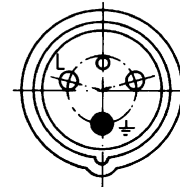

380 ... 415 V = 6 h

06190E00

Arrangement of socket contacts and terminal markings

2 P + \perp

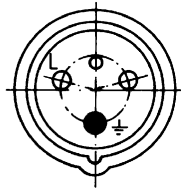

06190E00

8570/11-3..

3 P + \perp

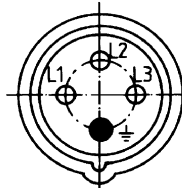

8570/11-4..

3 P + N + \perp

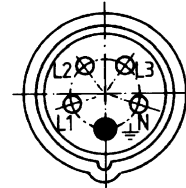

06556E00

8570/11-5..

06555E00

Arrangement of the socket contacts and terminal markings in the 6h position (view from the front side of the shrouded socket outlet to the socket contacts)

Colour code and arrangement of socket contacts and terminal markings

No. of poles*	Frequency [Hz]	Voltage [V]	Colour code	Position of earth contact sleeve
8570/11-3.. 2 P + \perp	50 and 60	100 ... 130	yellow	4 h
	50 and 60	200 ... 250	blue	6 h
	60	277 ¹⁾	light grey	5 h
	50 and 60	380 ... 415	red	9 h
	50 and 60	480 ... 500	black	7 h
	> 300 ... 500 ²⁾	> 50	green	2 h
	DC	> 50 ... 110	light grey	3 h
8570/11-4.. 3 P + \perp	50 and 60	100 ... 130	yellow	4 h
	50 and 60	200 ... 250	blue	9 h
	50 and 60	380 ... 415	red	6 h
	50	380	red	3 h
	60	440 ... 460 ¹⁾	red	11 h
	50 and 60	480 ... 500	black	7 h
	50 and 60	600 ... 690	black	5 h
	100 ... 300 ²⁾	> 50	green	10 h
	> 300 ... 500 ²⁾	> 50	green	2 h
8570/11-5.. 3 P + N + \perp	50 and 60	57/100 ... 75/130	yellow	4 h
	50 and 60	120/208 ... 144/250	blue	9 h
	50 and 60	200/346 ... 240/415	red	6 h
	50	230/400	red	3 h
	60	250/440 ... 265/460 ¹⁾	red	11 h
	50 and 60	277/480 ... 288/500	black	7 h
	50 and 60	347/600 ... 400/690	black	5 h

* All numbers of poles: All nominal operating voltages and/or frequencies not covered by other arrangements have the position of the earth contact sleeve 1 h.

Colour code and arrangement, relative to the polarizing slot, for different voltages and frequencies according to IEC 60309-2

¹⁾ Mainly for ship installations

²⁾ Frequencies ≥ 100 Hz lead to higher heating behaviour. This must be compensated by max. ambient temperature ≤ 40 °C, temperature class T5 or reduction of current to 12 A.

7.2 Mounting / Dismounting, Operating Position

7.2.1 Assembly

i	Install a protective roof or wall if mounted outdoors.
----------	--

Operating position

Hinged cover facing downwards, connection chamber - upwards.



- Fasten the wall-mounting socket by means of four screws in the vertical operating position on an even wall.

i	The fastening holes are designed as elongated holes. This allows vertical and horizontal adjustment during mounting.
----------	--

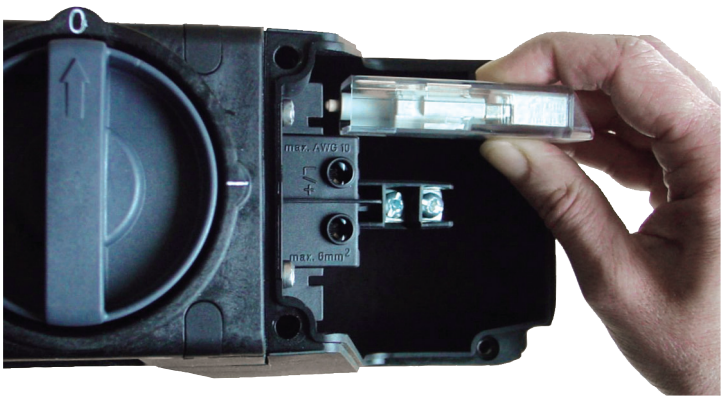
Mounting auxiliary contacts

 <small>11203E00</small>	<ul style="list-style-type: none">• Open the enclosure.• Snap the auxiliary contacts into place optionally in the left-hand or right-hand seat. Double equipping is possible.• Close the enclosure.
---	---

7.3 Installation

	<p style="text-align: center;">WARNING</p> <p>Danger due to live components! Risk of severe injuries!</p> <ul style="list-style-type: none"> • All connections and wiring must be disconnected from the power supply. • Secure the connections against unauthorized switching.
	<p style="text-align: center;">DANGER</p> <p>Explosion hazard! Risk of injuries and material damage!</p> <ul style="list-style-type: none"> • Select suitable conductors to ensure that the maximum permissible conductor temperatures are not exceeded. • When using the core end sleeves, attach them using a suitable tool. • Observe the insulating capacity and separation distances between intrinsically safe and non-intrinsically safe circuits according to EN 60079-14, section 12. • Use only separately tested cable glands and stopping plugs with EC Type Examination Certificate. • The conductor insulation must reach to the terminal. • Do not damage the conductor (e.g. nicking) when stripping it. • Always connect the protective conductor.
	<p>Two conductors can be installed under one connection terminal. The material and cross-section of both conductors must be identical. The conductors can be connected without any special preparations.</p>

	Dimensions [mm]	
	A	B
Main contacts	180	10
Auxiliary contacts	180	6
Ex i auxiliary contacts	20	6

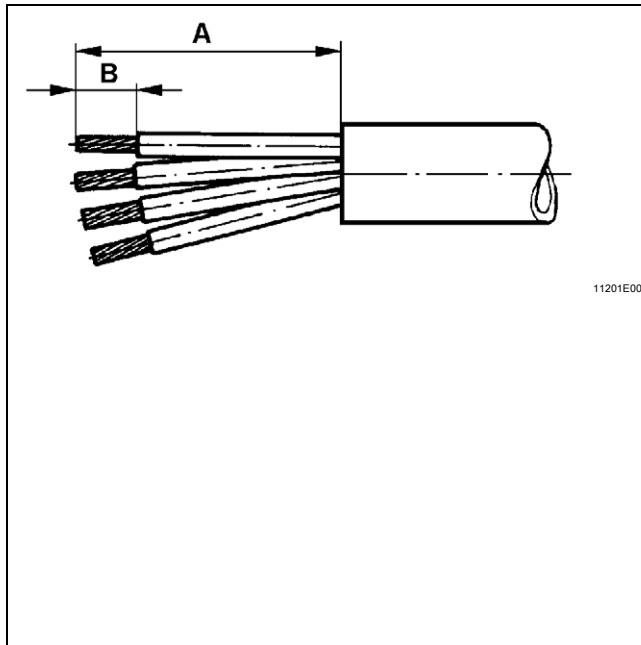

- Open the enclosure.
- Lead the cable through the cable gland into the connection chamber.
- Insert the conductors in the corresponding terminals and clamp them (for tightening torque, see chapter "Technical data"). The stripped cable ends must be fully underneath the clamping plate.
- Check if the conductors are clamped properly.
- Align the conductors (the clamping units must not be under tension).
- Tighten the cable gland(s).
- Close the enclosure.
For the tightening torque, see chapter "Technical data".

Installation of auxiliary contacts

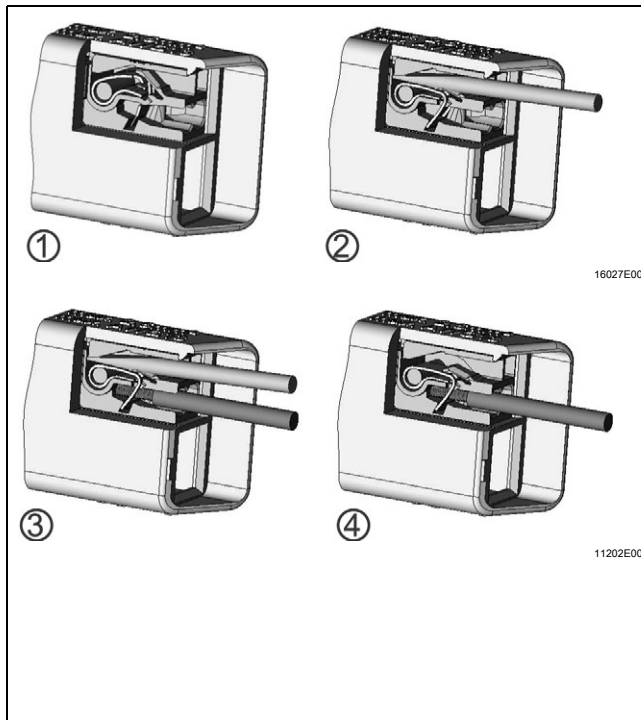

- Open the enclosure.
- Lead the cable through the cable gland into the connection chamber.
- Unlock the screwless type terminals by means of a screwdriver (2) (cutting edge 06 x 3.5 form A according to DIN 5264 or ISO 2380-1).
- Insert the conductors in the corresponding screwless type terminals and clamp them (3). The stripped conductor ends must be fully inside the terminal.
- Align the conductors (the clamping units must not be under tension).
- Tighten the cable gland(s).
- Close the enclosure.
For the tightening torque, see chapter "Technical data".

8 Commissioning



WARNING	
	<p>Check the device before commissioning! Explosion protection is impaired!</p> <ul style="list-style-type: none"> • Observe the inspection requirements in the current national regulations before commissioning in order to maintain the explosion protection. • Check the device for proper installation and function before commissioning.

Before commissioning, ensure the following:

- Check the mounting and installation.
- Enclosure must not be damaged.
- If necessary, remove foreign bodies.
- If necessary, clean the connection chamber.
- Check whether the cables have been inserted correctly.
- Check if all screws and nuts have been tightened firmly.
- Check whether all the cable entries and stopping plugs have been tightened firmly.
- Check whether all conductors have been clamped firmly.
- Observe the line voltage.
- Seal the unused cable entries with plugs certified to Directive 94/9/EC or IEC and unused drilled holes with stopping plugs certified to Directive 94/9/EC or IEC.
- Use only in completely mounted state.

	<p>Switching on and off has to be performed quickly and completely. Avoid switching positions between 0 and I (ON and OFF).</p>
---	---

9 Operation

	<p>The wall-mounting socket may only be operated when fully mounted.</p>
	<p>The wall-mounting socket can be switched only with the inserted plug. If the plug has been disconnected, close the hinged cover with the bayonet ring.</p>

Only Type 8570/12 and 8575/12 plugs by R. STAHL may be used.

10 Maintenance and Repair

	WARNING
	<p>Unauthorized work being performed on the device! Risk of injuries and material damage!</p> <ul style="list-style-type: none"> • Work performed on the device must only be carried out by appropriately authorized and trained personnel.



10.1 Maintenance

- Consult the relevant national regulations to determine the type and extent of inspections.
- Adapt inspection intervals to the operating conditions.

During maintenance of the device, check at least:

- if the cables are clamped properly;
- the enclosure, seals and surface of the plug pins for damage;
- sleeves for pollution;
- compliance with the permitted temperatures in accordance with IEC/EN 60079-0;
- whether the device is used according to its designated use.

10.2 Maintenance

	WARNING
	<p>Danger due to live components! Risk of severe injuries!</p> <ul style="list-style-type: none"> • All connections and wiring must be disconnected from the power supply. • Secure the connections against unauthorized switching.
	DANGER
	<p>Danger due to defective switching contacts! Risk of injuries and material damage!</p> <ul style="list-style-type: none"> • Replace the entire socket flange after each short circuit in the main circuit of the switch because the state of the switching contacts cannot be checked in hermetically sealed equipment.
	<p>Observe the relevant national regulations in the country of use.</p>

10.3 Repair

	DANGER
	<p>Danger due to improper maintenance/repair! Explosion protection is impaired!</p> <ul style="list-style-type: none"> • Repair work on the device must be performed only by R. STAHL Schaltgeräte GmbH.

10.4 Returning the Device

Use the "Service form" to return the device when repair/service is required.
On the internet site "www.stahl-ex.com" under "Downloads > Customer service":

- Download the service form and fill it out.
- Send the device along with the service form in the original packaging to R. STAHL Schaltgeräte GmbH.

11 Cleaning

- Clean the device only with a cloth, brush, vacuum cleaner or similar items.
- When cleaning with a damp cloth, use water or mild, non-abrasive, non-scratching cleaning agents.
- Do not use aggressive detergents or solvents.
- Prevent water and cleaning agents from penetrating the socket contacts.

12 Disposal

- Observe national and local regulations and statutory regulation regarding disposal.
- Separate materials when sending it for recycling.
- Ensure environmentally friendly disposal of all components according to the statutory regulations.

13 Accessories and Spare Parts

NOTICE	
Use only original accessories and spare parts by R. STAHL Schaltgeräte GmbH.	

	<p>For accessories and spare parts, see data sheet on our homepage www.stahl-ex.com.</p>
---	--