

ABE7R16T212

sub-base - soldered electromechanical relays ABE7 -
16 channels - relay 10 mm



Main

Range of product	Advantys Telefast ABE7
Product or component type	Sub-base with plug-in electromechanical relay
Sub-base type	Output sub-base
[Us] rated supply voltage	19...30 V conforming to IEC 61131-2
Number of channels	16

Complementary

Supply circuit type	DC
Product compatibility	ABR7S21
Contacts type and composition	1 NO
Status LED	1 LED per channel, green for channel status 1 LED, green for power ON
Polarity distribution	Polarity distribution contact common per 2 groups of 8 channels
Short circuit protection	1 A internal fuse, 5 x 20 mm, fast blow (PLC end) 0.5 A fuse per channel, 5 x 20 mm, fast blow (output circuit)
Fixing mode	By clips on 35 mm symmetrical DIN rail By screws on solid plate with fixing kit
Supply current	<= 1 A
Voltage drop on power supply fuse	0.3 V
[U _i] rated insulation voltage	2000 V between terminals/mounting rails 300 V between coil circuit/contact circuits conforming to IEC 60947-1
[U _{imp}] rated impulse withstand voltage	2.5 kV
Installation category	II conforming to IEC 60664-1
Tightening torque	0.6 N.m (with flat Ø 3.5 mm)
Product weight	0.73 kg

Environment

Product certifications	BV CSA DNV GL LROS (Lloyds register of shipping) UL
IP degree of protection	IP2x conforming to IEC 60529
Resistance to incandescent wire	750 °C conforming to IEC 60695-2-11
Shock resistance	15 gn for 11 ms conforming to IEC 60068-2-27
Vibration resistance	2 gn (f = 10...150 Hz) conforming to IEC 60068-2-6
Resistance to electrostatic discharge	4 kV (contact) conforming to IEC 61000-4-2 level 3 8 kV (air) conforming to IEC 61000-4-2 level 3
Resistance to radiated fields	10 V/m (26000000...1000000000 Hz) conforming to IEC 61000-4-3 level 3
Resistance to fast transients	2 kV conforming to IEC 61000-4-4 level 3
Ambient air temperature for operation	-5...60 °C conforming to IEC 61131-2
Ambient air temperature for storage	-40...80 °C conforming to IEC 61131-2
Pollution degree	2 conforming to IEC 60664-1

The information provided in this documentation contains general descriptions and/or technical characteristics of the products contained herein. This documentation is not intended as a substitute for and is not to be used for determining suitability or reliability of these products for specific user applications. It is the duty of any such user or integrator to perform the appropriate and complete risk analysis, evaluation and testing of the products with respect to the relevant specific application or use thereof. Neither Schneider Electric Industries SAS nor any of its affiliates or subsidiaries shall be responsible or liable for misuse of the information contained herein.

Dimensions

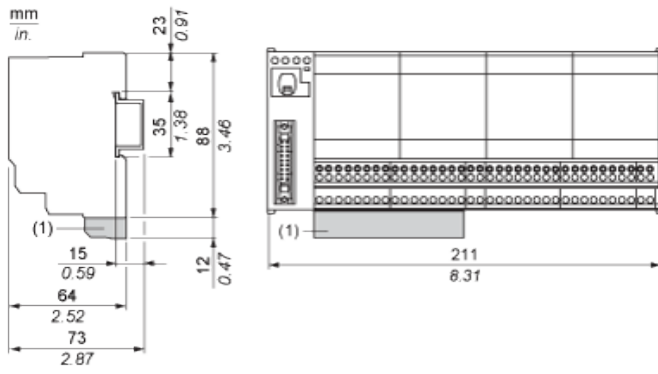

(1) ABE7BV10 / BV20, ABE7BV10E / BV20E

Mounting

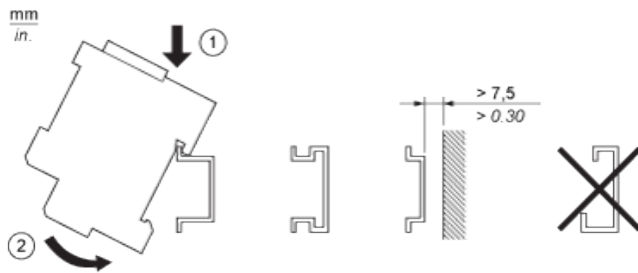

HE10 16 Channels

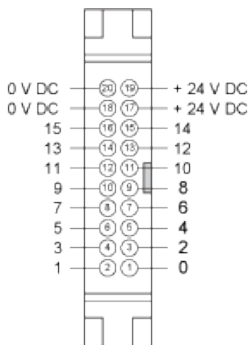

Wiring Diagram

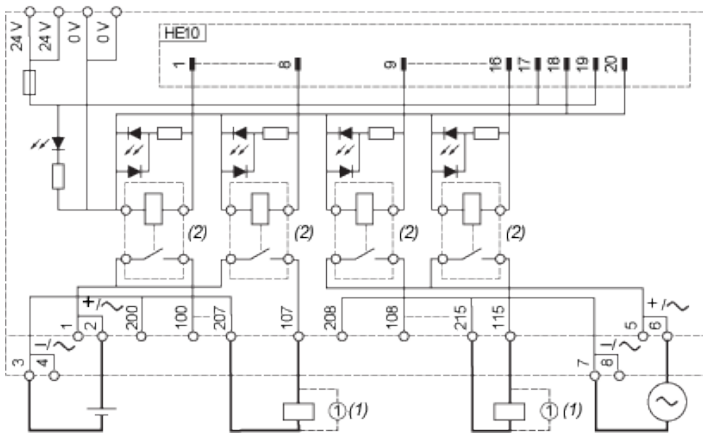
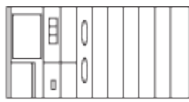

- (1) Inductive load
- (2) ABR7S21 (1 "F" "SPST") I_{th} = 5 A (supplied)

Curves for Determining Cable Type and Length According to the Current

16-channel Sub-base

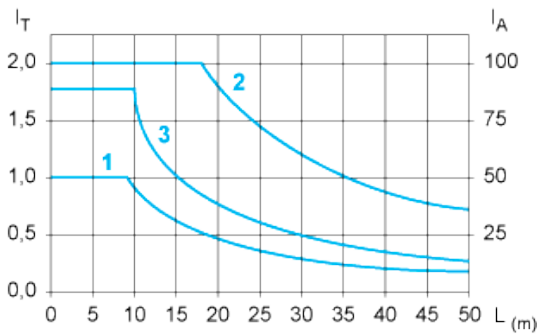

L Cable length

I_T Total current per sub base (A)

I_A Average current per channel (mA)

- (1) TSXCDP••2 and ABFH20H••0 cables with c.s.a. 0.08 mm² (AWG 28).
- (2) TSXCDP••3 cables with c.s.a. 0.34 mm² (AWG 22).
- (3) Cables with c.s.a. 0.13 mm² (AWG 26).

The curves are given for a voltage drop of 1 V in the cable. For n volts tolerance, multiply the length determined from the graph by n.

Temperature Derating Curves

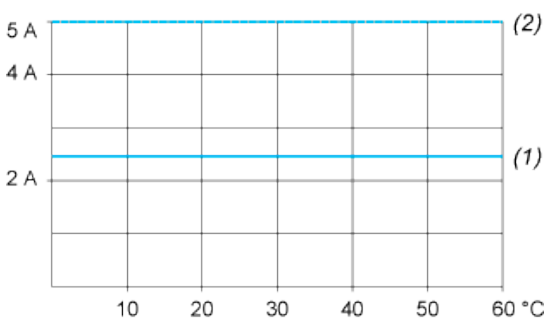

- (1) 100 % of channels used
- (2) 50 % of channels used

Electrical Durability (in Millions of Operating Cycles) Conforming to IEC 60947-5-1

Multiply all durability values by 0.75 for ABR7S23.

DC Loads

DC12 curves

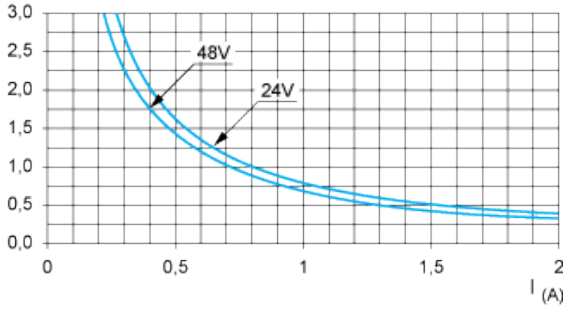

DC12 control of resistive loads and of solid state loads isolated by optocoupler, $I/R \leq 1$ ms.

DC13 curves

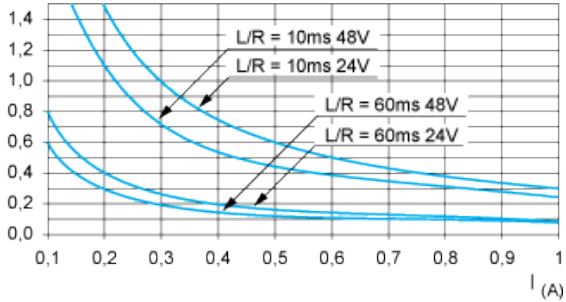

DC13 switching electromagnets, $L/R \leq 2 \times (U_e \times I_e)$ in ms, U_e : rated operational voltage, I_e : rated operational current (with a protective diode on the load, DC12 curves must be used with a coefficient of 0.9 applied to the number in millions of operating cycles)

AC Loads

AC12 curves

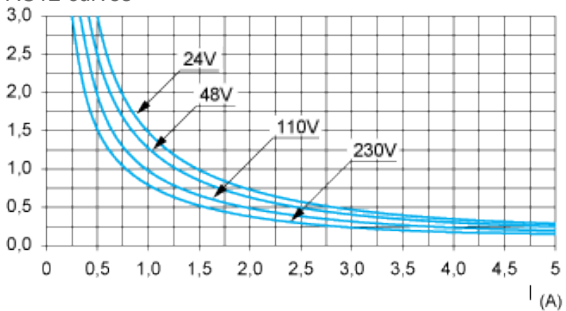

AC12 control of resistive loads and of solid state loads isolated by optocoupler, $\cos \phi \geq 0.9$.

AC14 curves

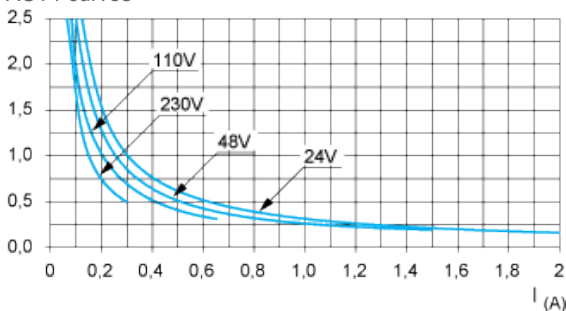

AC14 control of small electromagnetic loads ≤ 72 VA, make: $\cos \phi = 0.3$, break: $\cos \phi = 0.3$.

AC15 curves

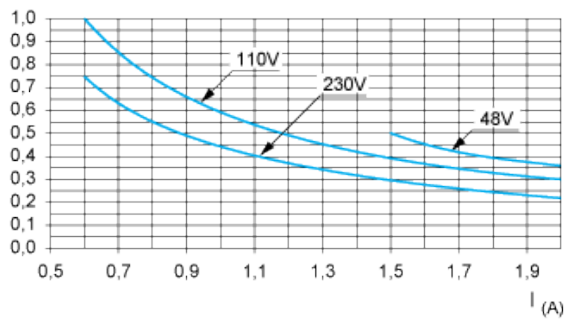

AC15 control of electromagnetic loads > 72 VA, make: $\cos \phi = 0.7$, break: $\cos \phi = 0.4$.