

introduction to the catalogue

page

- general overview of the production of multipole connectors for industrial purposes 3 ÷ 7
- general features of multipole connectors 8 ÷ 9
- standards governing the use of multipole connectors 10 ÷ 12
- features of inserts for multipole connectors 13 ÷ 17
- conductor connections 18 ÷ 20
- enclosure versions 21 ÷ 23
- enclosure and inserts combinations 24 ÷ 27
- inserts load curves 28 ÷ 35
- applications for higher voltages (CD page 38), (CDD page 52), (CQE page 73)

multipole inserts

page

- **CK - CKS** types 3 and 4 poles (10A) 36 ÷ 37
- **CD** types 7, 8, 15, 25, 40, 50, 64, 80, 128 poles (10A) 38 ÷ 47
- **CT - CTS** types 40 and 64 poles (10A) 48 ÷ 51
- **CDD** types 24, 38, 42, 72, 76, 108, 144, 216 poles (10A) 52 ÷ 60
- **CQ** types 12 poles (10A), 5, 8 poli (16A), 4+2 poles (40/10A) 61 ÷ 65
- **CDA - CDC** types 10, 16, 32 poles (16A) 66 ÷ 71
- **CQE** types 10, 18, 32, 46, 64, 92 poles (16A) 73 ÷ 79
- **CN - CCE - CNE - CSE - CSS** types 6, 10, 16, 24, 32, 48 poles (16A) 80 ÷ 103
- **CT - CTE - CTSE** types 6, 10, 16, 24 poles (16A) 104 ÷ 113
- **CMSE - CMCE - CME** types 3+2, 6+2, 10+2, 12+4, 20+4, 16+2, 32+4 poles (16A) 114 ÷ 125
- **CP** types 6, 12 poles (35A) 127 ÷ 128
- **CX** types 8/24 poles (16/10A), 6/36 and 12/2 poles (40/10A), 4/0, /2, /8 poles (80/16A) 129 ÷ 133
- **MIXO** types 12P (10A), 5P, 6P, 8P e 20P (16A), 2P and 3P (40A), 2P (100A), 1+1P and 4+4P (BUS-10A), 134 ÷ 151
1+4 and 2+8P (RJ45-10A), 2P (16A) for high voltage, 2 and 3 pneumatic contacts, frames for inserts

enclosures for inserts

page

- **CK** and **MK** types size "21.21" 153 ÷ 158
- **CQ** types size "32.13" 160 ÷ 161
- **CZ - MZ - MF** types size "49.16" 162 ÷ 165
- **CZ - MZ - MF** types size "66.16" 166 ÷ 169
- **CH - CA** and **MH - MA - MF** types size "66.40" 171 ÷ 174
- **CH - CA** and **MH - MA - MF** types size "44.27" 176 ÷ 182
- **CH - CA - CM - CMA** and **MH - MA - MM - MMA - MMF** types size "57.27" 184 ÷ 196
- **CH - CA - CM - CMA** and **MH - MA - MM - MMA - MMF** types size "77.27" 198 ÷ 210
- **CH - CA - CM - CMA** and **MH - MA - MM - MMA - MMF** types size "104.27" 212 ÷ 224
- **CH** and **MH - MF** types size "77.62" 226 ÷ 230
- **CH** and **MH - MF** types size "104.62" 232 ÷ 234



supports, special enclosures and accessories **page**

- special enclosures with dual outlets, widened, w/o outlets, for ribbon cables, for round cables, coupling, central lever 236 ÷ 243
- **CG** and **MG** types, high IP68 protection rating enclosures 244 ÷ 252
- **T-BOX** coupling with 1 or 2 branches 254 ÷ 255
- **COB** type mountings for panels 256 ÷ 260
- miscellaneous auxiliaries and accessories 262 ÷ 263
- PCB interfaces 264
- Constantan (CuNi) and iron (Fe) crimping contacts 265
- anchors for cables inside and outside enclosures, coding pins 266 ÷ 271
- **CKM T** terminal connector 272
- insert joining block, metal replacement handles, carrying cover, enclosure removal pliers 273 ÷ 274
- SUB-K insert plates, control equipment kits, plate only (**SDS**) and plate with enclosure (**CHSDS**) 275 ÷ 276
- blanking or adapter plates, pliers for MIXO BUS connectors removal 277
- adapters for **RJ45** connectors, coupling for **RJ45** connector 278 ÷ 279
- connectors for compliance with **DESINA**® standard 280 ÷ 291

crimping tools **page**

- crimping concept 293 ÷ 295
- manual tools 296 ÷ 303
- pneumatic tools 304 ÷ 307
- wire stripping - crimping machine 308 ÷ 309
- RJ45 crimp tool 310

Part Nos. and index **page**

- Part Nos. list 312 ÷ 322

Inserts

The inserts are made of self-extinguishing thermoplastic resin UL 94 V0, normally used for applications in a maximum ambience temperature of 125 °C. The special versions for use with a maximum ambience temperature of 180 °C are made of PPS. Different conductor connection techniques are available: screw connections, crimp connections, or flexible spring connections. The contacts are in silver or gold plated brass. The inserts are numbered on both sides by laser printing or moulded. There is a large number of versions of inserts selected on the basis of the rated voltage (from 50V to 5000V), the rated current (from 10A to 100A max), the number of poles, the different load combinations required (power and signal poles within the same insert). The inserts are approved in conformance with the major conformity marks including .

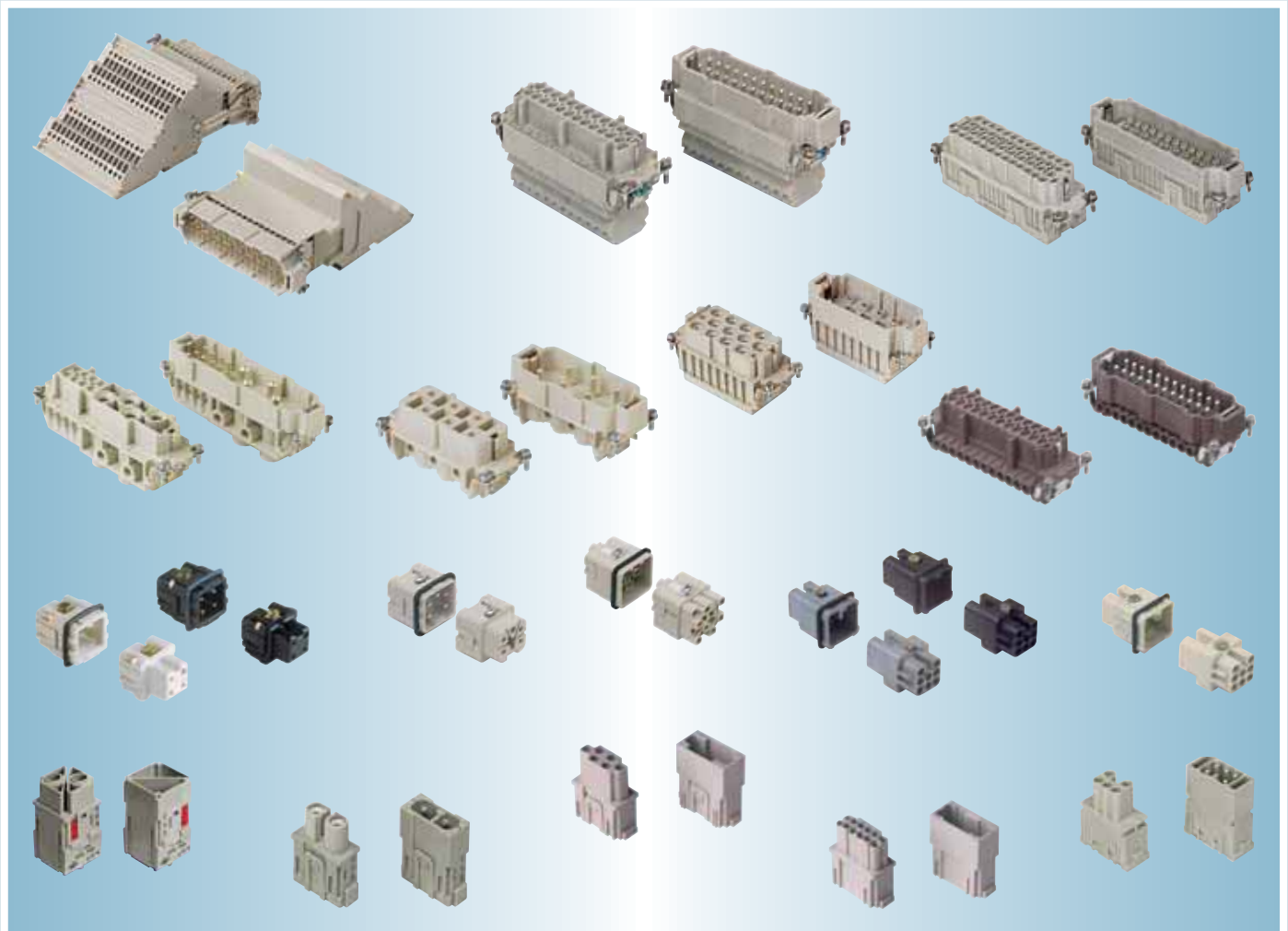

The RoHS (2002/95/EC) and RAEE (2002/96/EC) Directives

● The **RoHS 2002/95/EC** Directive bans the use of some harmful substances used in new electrical and electronic equipment commercially available from the 1st of July 2006 (the exceptions for some applications are enclosed in the Directive Enclosure and in some later decisions made by the EU Commission 1)). The banned and/or restricted substances are: **Lead, Mercury, Cadmium, Hexavalent Chromium, Poly-Brominated By-Phenyls and Poly-Brominated Dy-Phenyl Ethers** (PBB and PBDE respectively, fire retardant substances for thermoplastic materials).

● The **RAEE 2002/96/EC** Directive (with its later amendment 2003/108/EC) aims to recycle and reduce the waste produced by electrical and electronic equipment. It also promotes recycling and reusing such technological waste and establishes ambitious recovery rate targets, which vary according to the types of products involved. The manufacturers or their agents in the EU must ensure that the equipment sold after the 13th of August 2005 listed in the Enclosure I A and illustrated in the Enclosure I B of this Directive is collected, treated and recycled (the deadline varies from country to country. In Italy, the deadline has been postponed to 31/12/2007, awaiting for approval by the required executive Ministerial Decrees).

As a manufacturer of electrical equipment and components for industrial use, I.L.M.E. acknowledges the regulations introduced by these Directives. The above mentioned Directives are already effective in almost all EU countries. For the products described in this Catalogue, although the usage restriction of the above mentioned hazardous substances is not legally applicable (none of our product does in fact belong to any of the categories described and illustrated in the RoHS and RAEE Directives), the “**RoHS compliance**” may become important and many of our customers may require its compliance. We have therefore carried out the corrective actions, which have led to the “**RoHS compliance**” of all our products, wherever required. **I.L.M.E. products sold after the 1st of July 2006 do not contain any of the restricted substances in higher concentration than those allowed by the RoHS directive and by the later associated Decisions taken by the EU Commission.**

1) At the time of publication of this Catalogue, the following EU Commission Decisions were available: 2005/618/EC, of 18 August 2005, 2005/717/EC, of 13 October 2005, 2005/747/EC, of 21 October 2005, 2006/310/EC, of 21 April 2006, 2006/690/EC, 2006/691/EC, 2006/692/EC, of 12 October 2006.

The heavy duty multipole connectors for industrial purposes are used in electric and electronic machinery, control units, electric panels, control equipment and wherever connections are required for power and signalling circuits. (N.B. the connectors must not be handled live).

The connectors are in conformance with the standard DIN VDE 0627 (European standard IEC 61984) and where applicable, to the standard DIN 43652 (European standard EN 175301-801 developed by CENELEC TC48B).

Fire Safety Standards for the railway industry

The most advanced fire safety standards for the railway industry are the French standards:

- **NF F 16-101** Matériel roulant ferroviaire – Comportement au feu – Choix des matériaux
- **NF F 16-102** Matériel roulant ferroviaire – Comportement au feu – Choix des équipements électriques

which, in turn, refer to the test methods described in the following standards:

- **NF X 70 100** Analyse de gaz de pyrolyse et de combustion
- **NF X 10 702** Détermination de l'opacité des fumées en atmosphère non renouvelée

the latter being very similar in methods to the following American standards:

- **ASTM E 662** Standard Test Method for Specific Optical Density of Smoke Generated by Solid Materials
- **ASTM E 162** Standard Test Method for Surface Flammability of Materials Using a Radiant Heat Energy Source.

Equally as popular is the use of Bombardier Transportation toxicity specifications:

- **SMP 800-C** Toxic Gas Generation.

In Italy, since 2006, for installation on board of rolling-stocks, certification of conformity to the new Italian railway standards (listed below) is required:

- **UNI CEI 11170-1:2005** Trains and trams – Fire safety guidelines for trains, trams and guide vehicles – General principles
- **UNI CEI 11170-2:2005** Trains and trams – Fire safety guidelines for trains, trams and guided vehicles – Design recommendations – Fire containment measures – Indication, monitoring and evacuation systems
- **UNI CEI 11170-3:2005** Trains and trams - Fire safety guidelines for trains, trams and guided vehicles – Assessment of effect of fire on materials – Acceptable limits published by UNI and CEI together on 30/11/2005, in the delayed completion of the European standard relating to the effect of fire on materials to be installed on board of rolling-stocks, standard **EN 45545**, divided in 8 sections, only some of which have recently been published, after 16 years in the making, whilst the most crucial sections are still unfinished due to disagreements between the member countries (because of strong national interests, protectionism of domestic industries) especially in France, Germany, United Kingdom and Italy.

To date, this planned standard, to be published as a simple TS (Technical Specification) and to be complied with on a voluntary basis, cannot yet be used and, as for the implementation of the Directives for the railway industry (interoperability of high-speed and conventional railways), the current national standards in force in the single EU member states are regarded as equivalent in terms of safety.

For Italy, the requirements for materials relating to electrical connectors are contained in the 2nd schedule "Acceptability criteria for electrical and electronic materials and components" at the application "All other applications including inflammable materials" (all applications other than electric cables). For these applications, four tests are required to be carried out on the materials:

- The materials being affected by a small flame according to EN ISO 11925-2 with, according to the risk levels, for LR1 and LR2, a resistance to fire of the material of 15s; for LR3 and LR4, a resistance of 30s.
- Smokiness in compliance with French standard NF F 16-101 with IF better or equal to F2 for all risk levels. The material we use is classified as F1 (better than F2) according to the tests we carried out.
- Fume optical density measurement, in compliance with French standard NF X 10-702 (from NF F 16-101) with values ≤ 100 for all risk levels LR1...4.
- Toxicity measurement, in compliance with Italian standard CEI 20-37/7, with $T \leq 2$ for all risk levels LR1...4.

Tests

In 2006, we carried out laboratory tests approved by the French Railways SNCF, according to the above mentioned French standards **NF F 16-101** and **NF F 16-102**, the material we use in our connectors, which has been found to belong to **class F1** (Index Fumée **I.F. ≤ 20**) as well as a toxicity index (Index Toxicité Fumée) **I.T.C. = 20**.

Both these values meet the requirements set out by the French standards and by the Italian standard UNI CEI 11170-3 schedule 2, which relates to electrical connectors. We have also commissioned a qualified North American laboratory to carry out tests compliant with American standards, which have confirmed compliance with the requirements set out by the US Federal Transit Administration "Recommended Fire Safety Practices for Rail Transit Material Selection" for methods ASTM E 662 (NFPA 258) (fume specific optical density), ASTM E 162 (ASTM D3635) (surface inflammability ► flame propagation index) and Bombardier Transportation SMP 800-C (fumes and gases toxicity).

Test reports are available on request (please contact our Sales Offices).

All requirements have been met.

The connectors are suitable for use with alternate or direct current and facilitate the manufacture of sectional electric parts in complex machinery and installation and maintenance, in conformity with the European standard EN 60204-1. The connectors are designed for heavy duty industrial applications.

Enclosures

A large number of enclosure versions are available with different combinations of component materials, each one suitable to a specific installation: normal environmental conditions, high temperature environments, aggressive environments and environments that require electromagnetic compatibility. The principal parts are made in die cast aluminium alloy with a coating of epoxy-polyester powder or in self-extinguishing thermoplastic (CK and MK series). They are resistant to impacts and strong mechanical stress. The coupling stability and protection against accidental opening are assured by single or double closing devices comprising levers, springs and pegs in stainless steel or entirely in plastic (CK and MK series). Sealing is assured by special gaskets that protect the contact groups inside the enclosures against dust and aggressive agents. In general, the coupled enclosures with the appropriate connections guarantee an IP66 (CEI EN 60529) degree of protection. Furthermore, the majority of enclosures successfully complete the high pressure hot water jet test required by standard DIN 40050 - 9 with **IP69K** classification. A special, IP68 protection rated series is also available.



Our enclosures have been certified by UL as Recognised Components for the USA and Canada (UL mark) as accessories of our set of UL and CSA certified connector inserts (file UL E115072, file CSA 082270_0_000).

The certification has been achieved by successfully completing several tests carried out in compliance with standard **ANSI/UL 50** (Enclosures for Electrical Equipment) which is equivalent to the North American voluntary standard **NEMA 250** (NEMA = National Electrical Manufacturers Association) and to the equivalent Canadian standard **CSA C22.2 No.94** (Special Purpose Enclosures) for safety levels used in North America and required by the local installation codes (ex.: NFPA 70 National Electrical Code in the US, CSA system standards for Canada); more specifically:

- **Type 12** (= NEMA 12): for indoor use, similar to IP54 protection rating in compliance with standard IEC/EN 60529;
- **Type 4** (= NEMA 4): for outdoor and indoor use, similar to IP66;
- **Type 4X** (= NEMA 4X): for outdoor and indoor use, such as Type 4 + corrosion resistant, similar to IP66 protection rating.

The certification includes all the enclosures belonging to the **Standard** (grey), **W** (green), **R** (red), **S** (EMC) and **G** (IP68) series of all sizes, with Pg, ISO and NPT cable exits, all special versions referable to standard types, as well as CKA enclosures.

For further information, please contact I.L.M.E. SpA.

Supports, special enclosures and accessories

The supports, special enclosures and accessories provide the solution to the most diverse installation needs.

The extensive range of articles comprises: panel supports for inserts, special enclosures (housing with double outlet, wide housings, housings without outlets (to be punctured, housings for round cables, hoods), insert combination blocks, accessories for CT inserts, interface for printed circuits, kits for control equipment, plates for mounting D-SUB inserts onto enclosures, reducing plates and closure plates, protection lid for transportation, code pins.

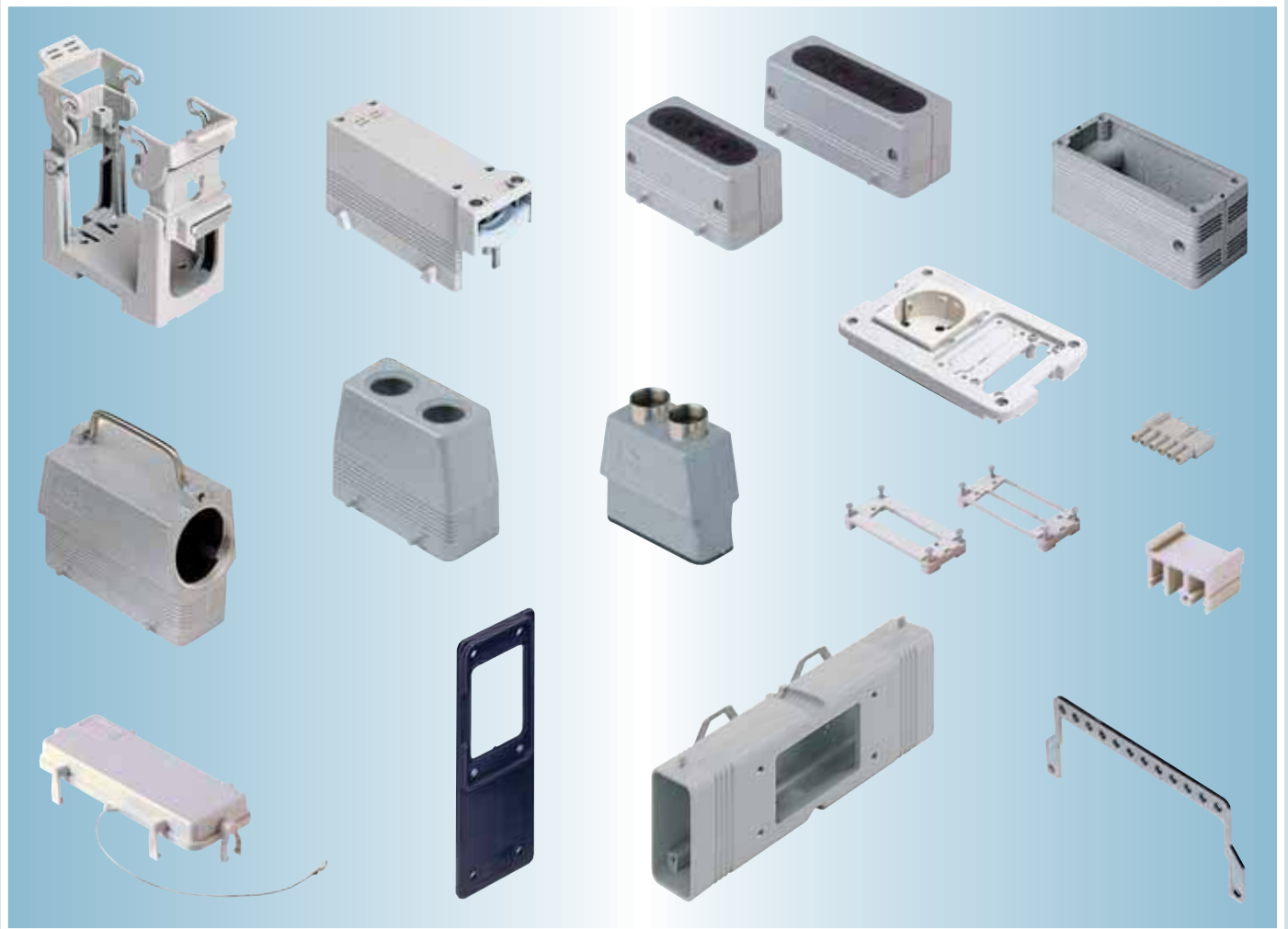

Tools

To guarantee the efficiency and security of the connections a complete series of specific tools is available for contact crimping that assure the maximum quality standards required by the standards.

Manual or automatic pneumatic tools for heavy production are available, together with a complete series of complementary tools for the mounting and dismounting of the contacts to be crimped.



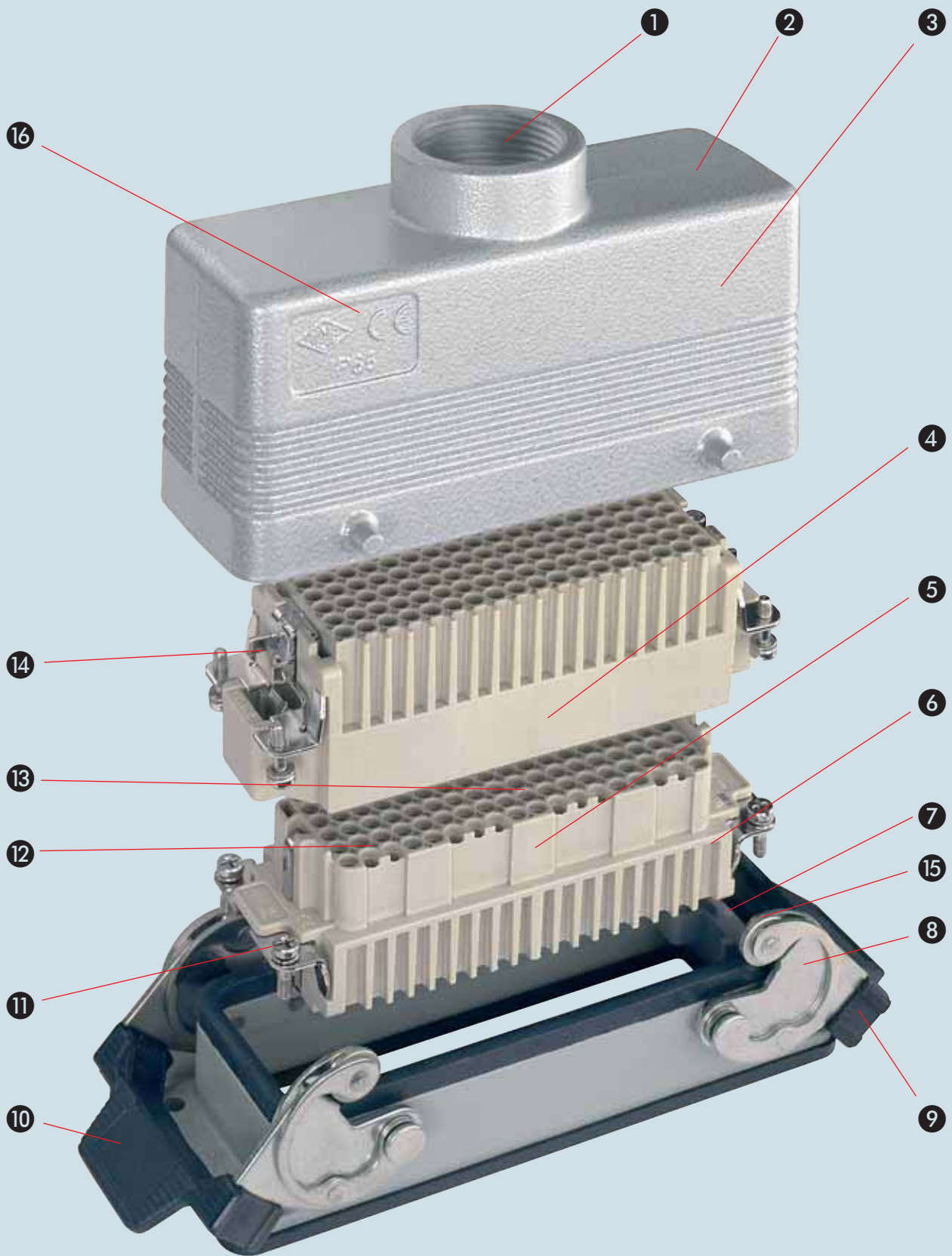

- 1 Threaded cable passage in various Pg diameters (types with pre-code "C") or metric passage (types with pre-code "M") in accordance with EN 60423, for cable entry devices in accordance with EN 50262 (NPT threading on request), may be located vertically, horizontally or frontally.
- 2 Heavy duty enclosures in die-cast aluminium alloy or self-extinguishing thermoplastic (CK and MK series). cRUus (UL) certified
Wall mounting or bulkhead housings and hoods are available, with or without fixed covers or with mobile protection covers.
The types of enclosures CH-CA (Pg cable entries) and MH-MA (metric cable entries) have a tab that prevents the insertion of inserts series CME (all) and CMCE (only 16+2 poles), while CM (Pg) enclosures series and MM (metric) do not have any tabs and contain supplementary insulating strips inside.
- 3 Metallic enclosures with a coated finish of epoxy-polyester with high resistance to mechanical stress and external agents. Enclosures used with temperatures of up to 180 °C and in aggressive environments are treated with special coatings. Where electromagnetic compatibility is necessary: EMC enclosures with high conductivity and high corrosion resistance surface treatment.
- 4 Inserts in self-extinguishing thermoplastic material reinforced with glass fibres, UL approved, with a limit working temperature from -40 °C to +125 °C.
The inserts CME (all) and CMCE (only 16+2 poles) for 830V have a key that prevents the insertion of inserts for use other than that prescribed (types CM - Pg and MM - metric).
For some series, inserts in PPS (polyphenylene sulphide) may be requested for special uses with temperatures of up to 180 °C.
- 5 Polarized inserts with asymmetric guide rails for preventing incorrect coupling.
The inserts have a mechanical duration equal to or over 500 coupling cycles.
- 6 Inserts manufactured in conformity with EN 61984 (DIN VDE 0627 standard and are certified and identified with the UL and CSA marks.
- 7 Special seal gaskets in vinyl nitrile elastomer or fluoro elastomer (on enclosures for use with maximum temperatures of 180 °C and for aggressive environments), in anti-aging, oil-resistant, fuel-resistant, together with the cable entry devices (not supplied) provide an IP66 degree of protection for coupled connectors.
Special conductive seals for EMC enclosures.

- 8 Stainless steel closure levers and springs guarantee a perfect closure and sealing.
- 9 Locking device available in two versions, simple (with one lever), or double (with two levers).
- 10 Various types of handles are available: in self-extinguishing, thermoplastic material reinforced with glass fibres; in die-cast aluminium (for special use with temperatures of up to 180 °C); monoblock stainless steel handles (CK, CZ, MK, MZ enclosures and for special uses with temperatures of up to 180 °C).
- 11 Unlosable insert fastening screws, with antiloosening flexible washer.

- 12 Contacts position identified with numbers or codes on both sides of each insert and laser printed or moulded.
- 13 Contacts in silver or gold-plated brass with connections to the conductors made via unlosable unloosened screws, spring terminal, crimping or incorporated 45° terminal block connectors (with screw or spring terminal).
- 14 Earth terminal protection with wide contact surface.
- 15 Pegs and levers supplied with anti-friction rings that facilitate closure and limit wear and tear.
- 16 CE marking attesting conformity to the requirements of the Low Voltage directive 73/23/EEC and its modification 93/68/EEC.

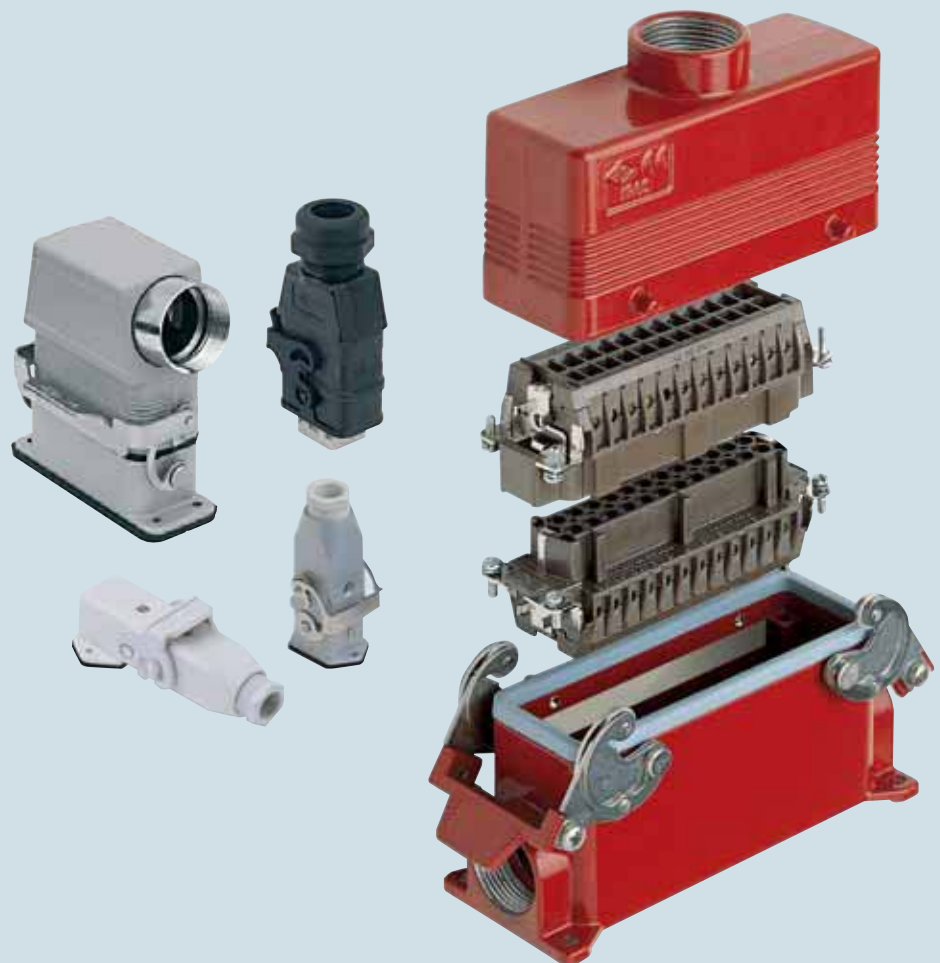

Dimensioning of clearances and creepage distances

European standard EN 61984 Ed. 1.0 (22001-11) was recently published for safety prescriptions for multipole connectors for industrial uses and for the relevant tests. This standard assimilates, without any modifications, the corresponding international standard IEC 61984 Ed.1.0 (2001-06).

It is applicable to connectors with rated voltage values of over 50V, and up to 1000V, and rated currents values of up to 125A per pole, for which no dedicated standard exists, or to which the particular specifications or the manufacturer refer as regards the safety aspects.

For determining the minimum through-air and surface insulation distances, i.e. creepage distances, for connectors, this standard makes use (with some modifications) of the concepts of standard IEC 60664-1 Ed. 1.0 (1992-10) ¹⁾. NOTE - For connectors with rated voltage values of up to 50V - excluded from the field of application of Low Voltage Directive 73/23/EEC - standard EN 61984 may be used as a guide. For surface and through-air insulation distances, refer to standard IEC 60664-1 Ed. (1992-10).

We are illustrating below the method of standard EN 61984 for determining minimum insulation values in connectors. The rated characteristics for each ILME connector family are provided on pages 14 and 15.

The following are now obsolete: the insulation group concept, and the distinction of rated voltage values into d.c. and a.c. voltage values 220V and 380V were adapted to standardised values 230V and 400V according to IEC 60038 ²⁾ and some concepts were taken from the regulations for LV electrical systems of the IEC 60364 ³⁾ series, as follows:

- The overvoltage categories (I, II, III, IV), according to the use of the equipment ⁴⁾. They are correlated to the transient overvoltages taken as a basis for determining the rated impulse withstand voltage
- The degrees of pollution
- The classification of insulating materials according to their resistance to tracking
- The conditions of the electrical field (homogenous or inhomogenous).

Overvoltage categories (or impulse withstand)

The overvoltage categories of a circuit or of an electrical system are identified by a conventional number (from I to IV) based on the limit or the control of the assumed transient overvoltage values obtained on a circuit or electrical system and depends on the means used to reduce the overvoltages.

TABLE 1

The rated impulse withstand voltage for equipment energised directly from the low-voltage mains (IEC 60664-1 Edition 1.0 1992-10)

Nominal voltage of the supply system based on IEC 60038 (CENELEC HD 472 S1, CEI 8-6)		Voltage line to neutral derived from nominal voltages a.c. or d.c. $\leq V$	Rated impulse withstand voltage ^{a)}			
V	V		Overvoltage category			
Three phase ^{b)}	Single phase		I	II	III	IV
		50	330	500	800	1500
		100	500	800	1500	2500
	120-240	150	800	1500	2500	4000
230/400 } 277/480 }		300	1500	2500	4000	6000
400 / 690		600	2500	4000	6000	8000
1000		1000	4000	6000	8000	12000

a) The "I" symbol indicates a four-wire three phase distribution system (star distribution). The lower value is the voltage between phase and neutral (phase voltage), whereas the higher value is the voltage between the phases (mains voltage).

Where only one value is indicated, it refers to three-wire, three-phase systems (delta distribution) and specifies the line-to-line value.

b) Equipment with these rated impulse withstand values can be used in installations in accordance with standard IEC 60364-4-443 (Italian standard CEI 64-8/4 Section 443, German standard DIN VDE 0100-443).

Table 1 supplies the rated impulse withstand voltage for equipment energised directly from the low voltage mains in function of the rated voltage of the power supply system, the relative voltage line-to-neutral and the overvoltage category. **Industrial machinery and installations with fixed connection to the low voltage supply system and consequently the relative components including multipole connectors, constitute an example of the equipment that belongs to the overvoltage category III.**

Examples of general equipment that comes under overvoltage category II are electrical household appliances, portable tools and other household equipment or similar.

For distribution networks with rated voltage of **230/400V** (star distribution with earthed neutral), and over-voltage category III (category III: impulse withstanding), the demanded rated impulse withstanding voltage is **4kV**.

For distribution networks with rated voltage of **400** or **500V** (star distribution without neutral or with insulated neutral, or delta distribution, insulated or corner-earthed), and over-voltage category III (category III: impulse withstanding), the demanded rated impulse withstanding voltage is **6kV**.

(1) Assimilated with modifications as European Harmonisation Document HD 625.1 S1:1996 and published by the CENELEC member countries as a national standard: Italian standard CEI 28-6 (1997-11), German standard DIN VDE 0110-1 (VDE 0110 Teil 1):1997-04.

(2) Harmonisation Document CENELEC HD 472 S1, Italian standard CEI 8-6, German standard DIN IEC 38:1987-05.

(3) Italian standard CEI 64-8, German standard DIN VDE 0100.

(4) HD 625.1 S1 modifies the definition to "impulse withstanding categories".

Degrees of pollution

Pollution indicates the presence of any kind of foreign matter, whether solid, liquid or gaseous (ionised gas) that can have a negative influence on the dielectric strength or on the surface resistivity of the insulating material.

The standard establishes four degrees of pollution. The categories are identified by conventional numbers based on the quantity of polluting agents or on the frequency of the phenomenon which determines the reduction of the dielectric strength and/or of the surface resistivity.

Pollution degree 1:

No pollution or only dry, non-conductive pollution.

The pollution has no influence.

Pollution degree 2:

Only non-conductive pollution except that occasionally a temporary conductivity caused by condensation may occur.

Pollution degree 3:

Conductive pollution or dry, non-conductive pollution which becomes conductive due to condensation which may occur.

Pollution degree 4:

The pollution generates persistent conductivity caused by conductive dust or by rain or snow.

Pollution degree 3 is typical of an industrial environment or similar, while pollution degree 2 is typical of a household environment or similar.

Standard EN 61984 permits the sizing of surface insulation distances of connectors installed in enclosures in protection class \geq IP54 for the degree of pollution immediately below that of the application environment (e.g.: 2 instead of 3).

Extract from standard EN 61984

6.19.2.2 For a connector in protection class IP54 or higher, according to Publication IEC 60529, the insulating parts inside the enclosure may be sized for a lower degree of pollution.

This applies also to coupled connectors, closure of which is ensured by the connector enclosure, and which may be uncoupled for test and maintenance purposes only.

One may therefore use connectors installed in enclosures or containers in protection class \geq IP54, at the rated data referring to degree pollution 2 in industrial applications with degree of pollution 3, if, in compliance with the standard, the coupling of the connectors is opened only occasionally for tests or maintenance. In the event of temporary or limited duration in uncoupled state, a closing cover is, however, necessary, guaranteeing at least protection class IP54. However, this does not apply to connectors which remain uncoupled and exposed to an industrial atmosphere for an indefinite period. It should be noted, however, that pollution could penetrate inside coupled connectors, also when it comes from remote parts of the electrical system (e.g. through conduits providing cable entry to the connectors enclosure).

Moreover, connector enclosures are usually supplied without cable entry devices, with the installer fitting such devices according to need. The degree of protection marked on the enclosures is guaranteed only for connectors coupled through the use of cable entry devices in equal or higher IP protection class and expertly installed.

Examples of application for the selection of degree of pollution 2 for a connector

- connector on an electric motor controller, which is uncoupled only to replace a faulty motor, also in cases where degree of pollution 3 is instead specified for the system;
- connector on a module-constructed machine, which is opened only for transport purposes and which is used only for faster installation and for safer putting into service. One must make sure that the connector has not been polluted during transport. To ensure this has not occurred, protective covers or adequate packing must be used;
- connector inside a panel in protection class \geq IP54. In this case one may even renounce equipping the connector with an IP54 enclosure.

Insulating material

Insulating material influences the determination of the minimum creepage distance. It is characterised according to the damage it suffers from the concentrated release of energy during scintillations when a surface leakage current is interrupted due to the drying of the contaminated surface.

The CTI (comparative tracking index), (index of resistance to surface currents) is assumed as index of the resistance to creep currents of the insulating materials in the presence of atmospheric contaminating agents.

The CTI constitutes the numeric value of the maximum voltage at which a material can resist against 50 drops of an electrolytic test solution without tracking, i.e. without a progressive formation of conductive paths on the surface of the solid insulating material (and permanent electric arc between the electrodes of the test equipment) due to the combined effect of electrical stress and electrolytic contamination.

The solid insulating materials are classified into four groups:

- Group I 600 \leq CTI
- Group II 400 \leq CTI < 600
- Group IIIa 175 \leq CTI < 400
- Group IIIb 100 \leq CTI < 175

The values for groups IIIa/IIIb (Table 6, EN 61984) are identical for the purpose of determining the creepage distance values.

The insulating materials used to manufacture the ILME multipole connectors belong to groups IIIa / IIIb.

Dimensioning of creepage distances

The minimum surface insulation distance (creepage distance), i.e. "the shortest distance along the surface of the insulation material between two conducting parts" [IE 60664-1 development 1.3.3] for connectors is prescribed by standard **EN 61984** in **Table 6**. It is determined according to rated voltage, degree of pollution and insulating material group. The rated voltage providing access to Table 6 (rationalised voltage of the feed system) is determined in Table 3a of IEC 60664-1 for single phase two or three wire a.c. or d.c. systems or Table 3b for three-phase three or four wire a.c. systems. Usually for three-phase systems with 230V/400V rated voltage, the conventional line-to-line insulation voltage is 400V and the line-to-earth for TT or TN systems is 250V. For three-phase systems with 400V or 500V rated voltage the conventional line-to-line insulation voltage is respectively 400V and 500V.

The degree of pollution must be specified according to standard IEC 60664-1. It strongly influences the rated insulation voltage of a connector. Therefore, the rated insulation voltage of a connector should be reconsidered time by time for each degree of pollution.

TABLE 3a

Single phase two or three wire a.c. or d.c. systems (IEC 60664-1 Edition 1.0 - 1992-10)

Nominal voltage of the supply system*) V	Voltages rationalised for Table 4 for insulation	
	line-to-line ¹⁾	line-to-earth ¹⁾
	A	B
12.5	12.5	-
24	25	-
25	25	-
30	32	-
42	50	-
48	50	-
50 **)	50	-
60	63	-
30-60	63	32
100 **)	100	-
110	125	-
120	125	-
150 **)	160	-
220	250	-
110-220	250	125
120-240	250	125
300 **)	320	-
220-440	500	250
600 **)	630	-
480-960	1000	500
1000 **)	1000	-

TABLE 3b

Three-phase three or four wire a.c. systems (IEC 60664-1 Edition 1.0 - 1992-10)

Nominal voltage of the supply system*) V	Voltages rationalised for Table 4 for insulation		
	line-to-line ¹⁾	line-to-earth ¹⁾	
	A	C	D
63	63	32	63
110	125	80	125
120	125	80	125
127	125	80	125
150 **)	160	-	160
208	200	125	200
220	250	160	250
230	250	160	250
240	250	160	250
300 **)	320	-	320
380	400	250	400
400	400	250	400
415	400	250	400
440	500	250	500
480	500	320	500
500	500	320	500
575	630	400	630
600 **)	630	-	630
660	630	400	630
690	630	400	630
720	800	500	800
830	800	500	800
960	1000	630	1000
1000 **)	1000	-	1000

Legenda:

A = All systems.

B = Single phase three-wire systems with mid-point earthed.

C = Three-phase four-wire systems [secondary winding of a star distribution transformer] neutral-earthed ²⁾.

D = Three-phase three-wire systems [secondary winding of a delta distribution transformer], unearthed ¹⁾ or corner-earthed.

1) The phase-earth insulation for unearthed or impedance-earthed lines is equal to that between phases, because the operating voltage of any phase can, in practice, approach full voltage between the phases [line voltage]. This is because the actual voltage to earth is determined by the insulation resistance and by the capacitive reactance of each phase to earth. Consequently, a low (but acceptable) insulation resistance of a phase can, in effect, earth it and increase voltage to earth of the other two phases at full voltage between the phases [line voltage].

2) For equipment for use on both three-phase three-wire and three-phase four wire supplies, earthed or unearthed, use only the values for three-wire systems.

*) Assuming a rated voltage of the equipment.

**) These values correspond to the values given in Table 1.

With this voltage value, the pollution degree and the materials group the minimum creepage distance can be determined using **Table 6**.

TABLE 6

Minimum creepage distances (EN 61984 Edition 1.0 - 2001-11)

Rated voltage r.m.s. value a.c. or d.c. V	Minimum creepage distances (mm)									
	Pollution degree									
	1	2			3			4		
		see note ^b	Material group		Material group		Material group			
	I^a	II	III	I	II	III^c	I	II	III^c	
63	0.2	0.63	0.9	1.25	1.6	1.8	2	2.1	2.6	3.4
80	0.22	0.67	0.95	1.3	1.7	1.9	2.1	2.2	2.8	3.6
100	0.25	0.71	1	1.4	1.8	2	2.2	2.4	3	3.8
125	0.28	0.75	1.05	1.5	1.9	2.1	2.4	2.5	3.2	4
160	0.32	0.8	1.1	1.6	2	2.2	2.5	3.2	4	5
200	0.42	1	1.4	2	2.5	2.8	3.2	4	5	6.3
250	0.56	1.25	1.8	2.5	3	3.5	4	5	6.3	7.5
320	0.75	1.6	2.2	3.2	4	4.5	5	6	7.3	8.6
400	1	2	2.8	4	4.5	5.3	6	7	8.5	10
500	1.3	2.5	3.6	5	6	7	8	9	11	13
630	1.8	3.2	4.5	6.3	8	9	10	11.1	13.6	16.1
800	2.4	4	5.6	8	9	10.5	12	13.8	17	20.2
1000	3.2	5	7.1	10	12	14	16	17	21	25

NOTE 1: The values for voltages $\leq 50V$ are supplied in IEC 60664-1, Table 4.

NOTE 2: The values in bold are reduced compared to those of Table 4 IEC 60664-1, in compliance with 2.4 of IEC 60664-1.

a Materials group I or materials group II, III, where the possibility of tracking is reduced in conformance with the conditions of paragraph 3.2 of IEC 60664-1.

b Materials group I, II, IIIa, IIIb

c Materials group IIIb is not recommended for application with pollution degree 3 above 630V and with pollution degree 4.

Recommended tightening torque and size of screwdriver

size of screw	connector type	tightening torque (Nm)	tightening torque (lb.in)	recommended size of screwdriver (mm)
M2.5	CT 40, 64	0.4	3.5	0.5x3
M2.6	CTE 06...24	0.4	3.5	0.5x3
Ø 2.9	CQ 04/2, CQ 08	0.7	6.2	Ph1
M3	screw of earthing terminal series CQ 05, CQ 12	0.5	4.4	0.5x3
M3	CDA	0.5	4.4	Ph0 or 0.6x3.5
M3	CK, CKS, CD 07, CD 08, CQ 05, CQ 12	0.5	4.4	0.5x3
M3	CN, CX 4/8 (16A)	0.5	4.4	0.6x3.5
M3	CN..Q, CX 4/8 Q (16A)	0.5	4.4	Ph0
M3	CNE, CME	0.5	4.4	Ph0 or 0.8x4
M3	screw of small earthing terminal, MIXO frames series	0.5	4.4	Ph1 or 1.0x5.5
M3	screw for fastening to enclosures, all series	0.5	4.4	Ph1 or 0.8x4
M3,5	screw of earthing terminal series CDA, CDC	0.8	7.1	Ph1 or 1.0x5.5
M4	screw of large earthing terminal, MIXO frames series	1.2	10.6	Ph1 or 1.0x5.5
M4	CP	1.2	10.6	Ph1 or 0.8x4
M4	screw of earthing terminal, all series except CDA, CDC, MIXO	1.2	10.6	Ph2 or 1.0x5.5
M6	CX 4/... (80A)	2.5	22.1	1.0x5.5

Increasing the tightening torque does not improve considerably the contacts resistances. The screw torques are selected according to standard EN 60999-1, to provide excellent mechanical, thermal and electric behaviour. The conductor or terminal may be damaged if the recommended values are significantly exceeded.

Stripping lengths

inserts	conductor section		stripping length (mm)
	(mm ²)	(AWG)	
connection technique			
Screw			
CK	0.75÷2.5	18÷14	6
CX 4/2 (16A)	0.75÷2.5	18÷14	7
CN	0.75÷2.5	18÷14	7
CNE	0.5÷2.5	20÷14	7
CNE..X	0.25÷2.5	24÷14	7
CDA	0.75÷2.5	18÷14	7
CDA..X	0.25÷2.5	24÷14	7
CTE 06...24	0.75÷2.5	18÷14	12
CT 40 and 64	0.14÷2.5	26÷14	12
CME	0.5÷2.5	20÷14	7
CP	1.5÷6	16÷10	10,5
CX 4/.. (80A)	4÷16	12÷5	14
Crimp			
CDD, CD, MIXO (10A), CQ 12	0.14÷2.5 *	26÷14	8 (* 6 for 2.5 mm ²)
CCE, CDC, CMCE, CQ, CQE, MIXO (16A)	0.5÷4	20÷12	7,5
CX, MIXO (40A)	1.5÷2.5	16÷14	9
	4÷6	12÷10	9,6
MIXO (100A)	16÷35	5÷2	15
Spring			
CSE, CTSE 06...24, CMSE, MIXO (CX 05 S), CSS	0.14÷2.5	26÷14	9...11
CTS 40/64	0.14÷2.5	26÷14	9...11
	non-prepared max 1 prepared	non-prepared max 18 prepared	
CKS	0.14÷2.5	26÷14	9...11
	non-prepared max 1.5 prepared	non-prepared max 16 prepared	

inserts series	No. of poles ¹⁾ code main contacts + ⊕	auxiliary contacts	nominal current ⁴⁾	EN 61984 (2001-11) pollution rating 3			EN 61984 (2001-11) pollution rating 2			UL/CSA certification ³⁾ nominal voltage AC or DC	certifications ³⁾
				nominal voltage	pulsed holding nominal voltage	pollution rating	nominal voltage	pulsed holding nominal voltage	pollution rating		
CK	3, 4	---	10A	250V	4kV	3	230/400V	4kV	2	600V	UL, CSA, CCC, GL
CKS	3, 4	---	10A	400V	4kV	3				600V	(UL), (CSA)
CD	8 (without ⊕)	---	10A	50V	0.8kV	3				50V	UL, CSA, CCC, GL
CD	7, 15, 25, 40, (50), 64, (80), (128)	---	10A	250V ²⁾	4kV	3	230/400V ²⁾	4kV	2	600V	UL, CSA, CCC, GL
CT	40, 64	---	10A	250V	4kV	3	230/400V	4kV	2	600V	UL, CSA, CCC, GL
CTS	40, 64	---	10A	250V	4kV	3	230/400V	4kV	2	600V	UL, CSA, CCC, GL
CDD	24, 38, 42, 72, (76), 108, (144), (216)	---	10A				250V	4kV	2	600V	UL, CSA, CCC, GL
CQ 12	12	---	10A	400V	6kV	3	400/690V	6kV	2	600V	(UL), (CSA)
CQ 05	5	---	16A	230/400V	4kV	3	320/500V	4kV	2	600V	UL, CSA, CCC, GL
CQ 04/2	4	---	40A	400/690V	6kV	3				600V	cUL ^{A)}
		2	10A	250V	4kV	3					
CQ 08	8	---	16A	500V	6kV	3	400/690V	6kV	2	600V	cUL ^{A)} , CCC
CDA	10, 16, (32)	---	16A	250V	4kV	3	230/400V	4kV	2	600V	UL, CSA, CCC, GL
CDC	10, 16, (32)	---	16A	250V	4kV	3	230/400V	4kV	2	600V	UL, CSA, CCC, GL
CQE	10, 18, 32, 46, (64), (92)	---	16A	500V ²⁾	6kV	3	830V ²⁾	8kV	2	600V	UL, CSA, CCC, GL
CCE	6, 10, 16, 24, (32), (48)	---	16A	500V	6kV	3	400/690V	6kV	2	600V	UL, CSA, CCC, GL
CN	6, 10, 16, 24, (32), (48)	---	16A				400V	4kV	2	600V	UL, CSA, CCC, GL
CNE	6, 10, 16, 24, (32), (48)	---	16A	500V	6kV	3	400/690V	6kV	2	600V	UL, CSA, CCC, GL
CSE	6, 10, 16, 24, (32), (48)	---	16A	500V	6kV	3	400/690V	6kV	2	600V	UL, CSA, CCC, GL
CSS	6, 10, 16, 24, (32), (48)	---	16A	500V	6kV	3	400/690V	6kV	2	600V	UL, (CSA), CCC
CTE (**)	6, 10, 16, 24	---	16A	500V ^(*)	6kV	3				600V	(UL), (CSA), CCC, GL
CTSE	6, 10, 16, 24	---	16A	500V	6kV	3	400/690V	6kV	2	600V	UL, (CSA), CCC, GL
		2, (4)									
CME	3, 6, 10, (12), (20), (32) 16	---	16A	830V	8kV	3	1000V 720/1250V	8kV 8kV	2 2	600V	UL, (CSA), CCC
		2, (4)		400/690V 500V	6kV 6kV	3 3					
CMSE	3, 6, 10, (12), (20)	---	16A	830V	8kV	3	1000V 720/1250V	8kV 8kV	2 2	600V	UL, (CSA), CCC
		2, (4)		500V	6kV	3					
CMCE	3, 6, 10, (12), (20), (32) 16	---	16A	830V	8kV	3	1000V 720/1250V	8kV 8kV	2 2	600V	UL, (CSA), CCC
		2, (4)		400/690V 500V	6kV 6kV	3 3					
CP	6, (12)	---	35A	400/690V	6kV	3				600V	UL, CSA, CCC
CX 8/24	8	---	16A	230/400V	4kV	3	400V	4kV	2	600V	UL, CSA, CCC, GL
		24	10A	160V	2.5kV	3	250V	4kV	2		
CX 6/36	6	---	40A	690V	8kV	3				600V	UL, CSA, CCC, GL
		36	10A	160V	2.5kV	3	250V	4kV	2		
CX 12/2	12	---	40A	690V	8kV	3				600V	UL, CSA, CCC, GL
		2	10A	250V	4kV	3					
CX 4/0	4	0	80A	690V	8kV	3				600V	UL, CSA, CCC, GL
CX 4/2	4	---	80A	690V	8kV	3				600V	UL, CSA, CCC, GL
		2	16A	400V	6kV	3	400/690V	6kV	2		
CX 4/8	4	---	80A	400V	6kV	3	400/690V	6kV	2	600V	UL, CSA, CCC, GL
		8	16A	230/400V	4kV	3	400V	4kV	2		

(*) = until stocks of CT series connectors with nominal voltage 400V - 4kV - 2, UL, CSA certified last

N.B.: all inserts have a mechanical life equal to or higher than 500 mating cycles

- 1) Polarities shown in brackets can be achieved by using two inserts.
 - 2) Contacts partially fitted inside an insert allow inserts to be used for applications requiring nominal voltages higher than those shown.
See tables in page 38 (CD inserts), page 52 (CDD inserts) and page 73 (CQE inserts)
 - 3) Certifications shown in brackets are currently being applied for.
 - 4) Please check the insert load curves to establish the actual maximum operating current according to the ambient temperature.
See diagrams from page 28 to page 34
- A) UL for USA and Canada

inserts code	contact resistance ≤	insulation resistance ≥	ambiance temperature limit ⁵⁾ (°C)		degree of protection without enclosures	conductor connections ⁶⁾				
			min	max		axial screw	screw	spring	45° terminal block	crimp
CK	1 mΩ	10 GΩ	-40	+100	IP20		✓			
CKS	1 mΩ	10 GΩ	-40	+125	IP20			✓		
CD	3 mΩ	10 GΩ	-40	+125	IP20					✓
CD	3 mΩ	10 GΩ	-40	+125	IP20					✓
CT	4 mΩ	10 GΩ	-40	+125	IP20		✓		✓	
CTS	4 mΩ	10 GΩ	-40	+125	IP20			✓	✓	
CDD	3 mΩ	10 GΩ	-40	+125	IP20					✓
CQ 12	3 mΩ	10 GΩ	-40	+125	IP20					✓
CQ 05	1 mΩ	10 GΩ	-40	+125	IP20					✓
CQ 04/2	0.3 mΩ 3 mΩ	10 GΩ	-40	+125	IP20					✓
CQ 08	1 mΩ	10 GΩ	-40	+125	IP20					✓
CDA	1 mΩ	10 GΩ	-40	+125	IP20		✓			
CDC	1 mΩ	10 GΩ	-40	+125	IP20					✓
CQE	1 mΩ	10 GΩ	-40	+125	IP20					✓
CCE	1 mΩ	10 GΩ	-40	+125	IP20					✓
CN	1 mΩ	10 GΩ	-40	+125	IP20		✓			
CNE	1 mΩ	10 GΩ	-40	+125	IP20		✓			
CSE	3 mΩ	10 GΩ	-40	+125	IP20			✓		
CSS	3 mΩ	10 GΩ	-40	+125	IP20			✓		
CTE (**)	4 mΩ	10 GΩ	-40	+125	IP20		✓		✓	
CTSE	4 mΩ	10 GΩ	-40	+125	IP20			✓	✓	
CME	1 mΩ	10 GΩ	-40	+125	IP20		✓			
CMSE	3 mΩ	10 GΩ	-40	+125	IP20			✓		
CMCE	1 mΩ	10 GΩ	-40	+125	IP20					✓
CP	0.5 mΩ	10 GΩ	-40	+125	IP20		✓			
CX 8/24	1 mΩ 3 mΩ	10 GΩ	-40	+125	IP20					✓
CX 6/36	0.3 mΩ 3 mΩ	10 GΩ	-40	+125	P20					✓
CX 12/2	0.3 mΩ 3 mΩ	10 GΩ	-40	+125	IP20					✓
CX 4/0	0.3 mΩ	10 GΩ	-40	+125	IP20		✓			
CX 4/2	0.3 mΩ 1 mΩ	10 GΩ	-40	+125	IP20		✓			
CX 4/8	0.3 mΩ 1 mΩ	10 GΩ	-40	+125	IP20		✓			

(**) = until stocks of CT series connectors with nominal voltage 400V - 4kV - 2, UL, CSA certified last

5) It may be used with ambient temperatures up to 180 °C by using the insert special version made of PPS (polyphenylene sulfide)

6) See wires connection details on the next page.



inserts	N. poles ¹⁾	auxiliary contacts	nominal current ⁴⁾	EN 61984 (2001-11) pollution rating 3			EN 61984 (2001-11) pollution rating 2			UL/CSA certification ³⁾	certifications ³⁾
				nominal voltage	pulsed holding nominal voltage	pollution rating	nominal voltage	pulsed holding nominal voltage	pollution rating		
code	main contacts + ⊕										
MIXO											
CX 02 G	2 (without ⊕)	---	100A	1000V	8kV	3	920/1600V	8kV	2	600V	cUL ^{A)} , CCC, GL
CX 02 4A	2 (without ⊕) (2.5 - 8 mm ²)	---	40A	1000V	8kV	3	1600V	12kV	2	600V	(UL), (CSA)
CX 02 4B	2 (without ⊕) (6 - 10 mm ²)	---	40A	1000V	8kV	3	1600V	12kV	2	600V	(UL), (CSA)
CX 02 H	2 (without ⊕)	---	16A	2900/5000V	15kV	3					
CX 03 4	3 (without ⊕)	---	40A	400/690V ^(*)	6kV	3				600V	UL, CSA, CCC, GL
CX 05 S	5 (without ⊕)	---	16A	400V	6kV	3	500V	6kV	2	600V	UL, CSA, CCC, GL
CX 06 C	6 (without ⊕)	---	16A	500V	6kV	3	400/690V	6kV	2	600V	UL, CSA, CCC, GL
CX 08 C	8 (without ⊕)	---	16A	400V	6kV	3	400/690V	6kV	2	600V	UL, CSA, (CCC)
CX 12 D	12 (without ⊕)	---	10A	160V	2.5kV	3	250V	4kV	2	600V	UL, CSA, CCC, GL
CX 20 C	20 (without ⊕)	---	16A	500V	6kV	3	830V	8kV	2	600V	(UL), (CSA)
CX P	2, 3	---		pneumatic contacts for up to 8 bar compressed air							UL, CSA, CCC, GL
CX 02 B	2 ^(**) (without ⊕)	---	---	50V	0.8kV	3				(50V)	UL, CSA, CCC
CX 01 B	1 (+ screening)	---	10A	50V	0.8kV	3				(50V)	UL, (CSA)
CX 04 B	4 (+ screening)	---	10A	50V	0.8kV	3				(50V)	UL, CSA, CCC
CX 01 J	1 RJ45 insert (without ⊕)										(UL), (CSA)
		4	10A	250V	4kV	3					
CX 02 J	2 RJ45 inserts (without ⊕)										(UL), (CSA)
		8	10A	250V	4kV	3					

^(*) = with up to 5 mm section cable

^(**) = CX 04 B (4P) multiaxial connectors or CX 01 B coaxial connector

N.B. all inserts have a mechanical life equal to or higher than 500 mating cycles

1) Polarities shown in brackets can be achieved by using two inserts.

3) Certifications shown in brackets are being applied for.

4) Please check the insert load curves to establish the actual maximum operating current according to the ambient temperature.

See diagrams from page 34 to page 35

A) UL for USA and Canada

Nominal Data

Nominal data complies with requirements of EN 61984 standard.

Marking example to be applied only in a mains power supply with insulated neutral or with neutral to earth in a corner (see Table 5, EN 61984):



Marking example to be applied in any mains power supplies, including those with insulated neutral and the delta power supplies with earth in a corner (see Table 5, EN 61984):



insert series	contact resistance	insulation resistance	ambient temperature limits ⁵⁾ (°C)		protection rating	wirer connection ⁶⁾					
			min	max		without enclosures	axial screw	screw	spring	connection block at 45°	crimp
MIXO											
CX 02 G	0.3 mΩ	10 GΩ	-40	+125	IP20						✓
CX 02 4A	0.5 mΩ	10 GΩ	-40	+125	IP20	✓					
CX 02 4B	0.5 mΩ	10 GΩ	-40	+125	IP20	✓					
CX 02 H	1 mΩ	10 GΩ	-40	+125	IP20						✓
CX 03 4	0.3 mΩ	10 GΩ	-40	+125	IP20						✓
CX 05 S	3 mΩ	10 GΩ	-40	+125	IP20			✓			
CX 06 C	1 mΩ	10 GΩ	-40	+125	IP20						✓
CX 08 C	1 mΩ	10 GΩ	-40	+125	IP20						✓
CX 12 D	3 mΩ	10 GΩ	-40	+125	IP20						✓
CX 20 C	1 mΩ	10 GΩ	-40	+125	IP20						✓
CX P			-40	+125	IP20	coupling					
CX 02 B	---	10 GΩ	-40	+125	IP20	coupling					
CX 01 B	3 mΩ	10 GΩ	-40	+70	IP20						✓
CX 04 B	3 mΩ	10 GΩ	-40	+70	IP20						✓
CX 01 J			-20	+120	IP20						✓
	3 mΩ	10 GΩ	-20	+120	IP20						✓
CX 02 J			-20	+120	IP20						✓
	3 mΩ	10 GΩ	-20	+120	IP20						✓

5) It may be used with ambient temperatures up to 180 °C by using the insert special version made of PPS (polyphenylene sulfide)

6) See wire connection details on the next page.

contacts with screw terminal connections with or without wire protection

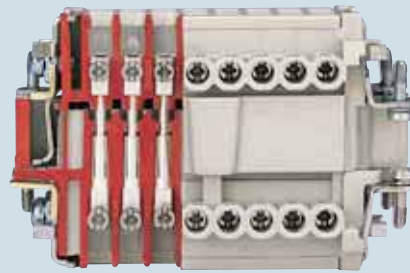

screw connected contacts in built-in terminal block

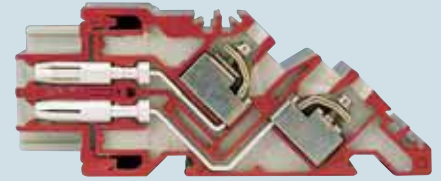

description

The different types of conductor connections to the male and female inserts are described on the right. The types are summarised as follows:

- screw terminals
- spring connection terminals
- connectors with incorporated terminal block
- crimp terminals

N.B.:
for all inserts with screw terminals it is important that the right torsional torque is applied to the screws in order to prevent wrong contacts or damage to the conductor, the screw or the terminal (see data mentioned in the inserts pages).

The 10A and 16A crimp contacts are available either **silver** or **gold-plated**. The gold-plated crimp contacts are recommended for applications with very low rated currents and rated voltages. Thanks to the conduction characteristics of gold, the deterioration of signals is prevented and an excellent residence to the superficial oxidation of the contacts is obtained. Gold-plated contacts are recommended with signals with ± 5 mA current and ± 5 V voltage.

description

inserts: CK - CDA - CN - CNE - CME - CP - CX

The connections of the conductors to the female and male inserts is made via screws (in accordance with standard EN 60999-1). Two different types of clamping are possible:

- with wire protection that does not require preparation of the conductors
- without wire protection that requires the conductors to be prepared with bush terminals

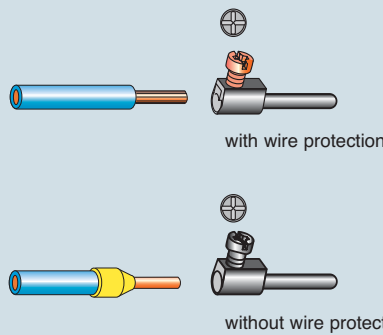

inserts: CX..A / CX..B

The connections of the conductors to the female and male inserts is made via screws (in accordance with standard). Fully insert the wire in the back of the contact; insert a 2mm hexagonal key in the front of the contact and tighten by holding down the cable.

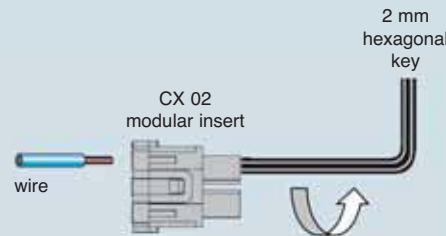

description

insert series: CTE

In this layout the wires are connected to the socket and plug insert contacts by means of a screw for all CTE inserts (in compliance with EN 60999-1). The inserts contain:

- a terminal block at 45° for fixed installation on electrical panels or on built-in DIN EN 60715 rail, for easier wire cabling and identification operations
- screw connection with pressure plate which does not require the wires to be prepared (CTE inserts).

CTE insert connection

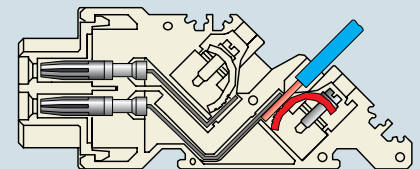

contacts connected with spring terminal, in built-in terminal block

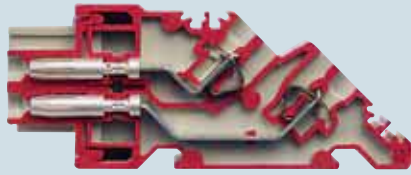

description

insert series: CTSE- CTS

With terminal block at 45° built-in for fixed installation on electrical panels or on built-in DIN EN 60715 rail, for easier wire cabling and identification operations. Spring terminal connection which does not require wire preparation (CTSE inserts). A screwdriver with a 3.5 x 0.5 mm blade is the only tool required to insert the wire in the contact.

CTSE insert connection

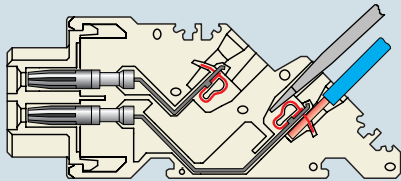

contacts connected with dual spring terminal



description

insert series: CSS

Equipped with two terminals per contact. This type of connection allows a circuit to be branched off. A screwdriver with a 3.5 x 0.5 mm blade is the only tool required to insert the wire in the contact.

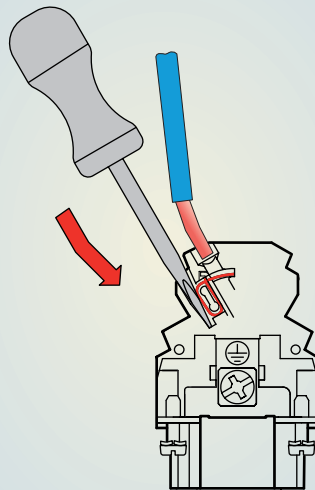

contacts connected with spring terminal



description

insert series: CSE - CMSE

In this layout the wires are connected to the socket and plug insert contacts by means of a spring terminal. This type of connection offers the following advantages:

- no special wire preparation
- a screwdriver with a 3.5 x 0.5 mm blade is the only tool required to insert the wire in the contact.
- it offers an excellent fastening solution and a great resistance to strong vibrations.
- allows rigid and flexible wires with sections between 0.14 and 2.5 mm² to be used
- allows conductivity tests under load to be carried out through the screwdriver insertion section, without splitting the insert.
- greatly reduces insert preparation and cabling times.

Spring terminal connection operating principles

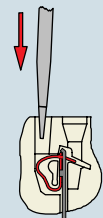

stage 1
when the screwdriver is inserted in the square housing provided, the wire housing in the spring is opened.

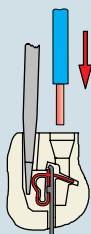

stage 2
the wire is pushed all the way in the round housing provided.

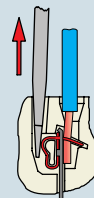

stage 3
when the screwdriver is removed, the spring is held down on the inserted wire.

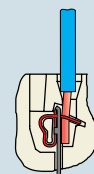

stage 4
the connection is complete; pull on the wire to make sure that the spring firmly holds down the wire.

**Removable crimp contacts
(with retainer device)**

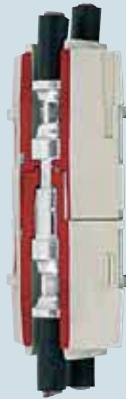

description

inserts: MIXO 100A

This layout enables the wires to be connected to the socket and plug insert removable contacts by crimping them with a crimp tool and its locating turret. This innovative insert design, **patented by ILME**, allows crimped contacts to be quickly fitted and removed. The special plates provided fasten the contact holder; after the insert has been mated to the other inserts and is inserted in the MIXO frame, connection is ensured and is **extremely resistant even to the most insidious strains**, such as vibrations. Contacts can be removed **without having to use any specific tools**, but by simply using a screwdriver.

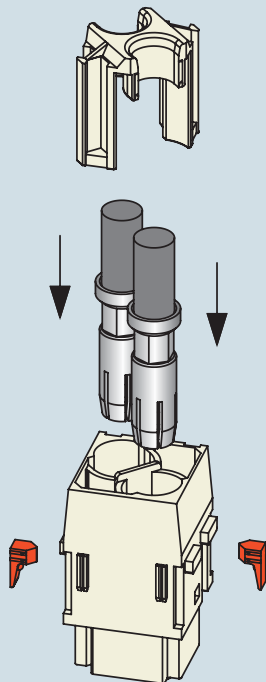

100A max contacts

wire section (mm ²)	AWG	identification
16	6 - 5	Ø hole 5.5 mm
25	4 - 3	Ø hole 7.0 mm
35	2	Ø hole 7.9 / 8.2 mm

Contacts are supplied in the silver plated version only

**Removable crimp contacts
(with retainer device on contacts)**



description

inserts: CD - CDD - CX - MIXO

The connections of the conductors to the removable contacts of the male and female inserts are made via crimping with a crimping tool and locator. The crimped connections are then inserted (with a fitting tool for sizes 1 and 2, without any tools for sizes 2, 3, 4 and 5) in the above mentioned sizes and are kept firmly in place by means of the flexible device fitted on the contacts. The wire housing entry on the contact is tapered to facilitate wire insertion and to avoid any damages occurring after the crimping operation. To remove connections, a special extractor tool must be used.

10A max contacts

conductor section (mm ²)	AWG	number identification
0.14 ÷ 0.37	26 ÷ 22	
0.5	20	
0.75	18	
1	18	
1.5	16	
2.5	14	

Contacts are supplied in the silver or gold plated version

**Removable crimp contacts
(with retainer device inside insert)**



description

inserts:
CQ - CQE - CCE - CDC - CMCE - CX - MIXO

The connections of the conductors to the removable contacts of the male and female inserts are made via crimping with a crimping tool and locator. The crimped connections are then introduced (without having to use any tool, except for size 1, which requires the use of a fitting tool) in the inserts of the above mentioned series and are firmly held in place by means of a retainer device fitted on the insert which holds down the contact. The contact can be removed by simply using a flat head 3mm screwdriver through the openings provided in the inserts (CDC, CMCE 16+2, CX 8/24 series) or by means of special extractor tools, to unlock the retainer device and release the contact (CQ, CCE, CMCE, CQE, CX, MIXO series). The wire housing entry on the contact is tapered to facilitate wire insertion and to avoid any damages occurring after the crimping operation.

16A max contacts

conductor section (mm ²)	AWG	throat identification
0.5	20	
0.75	18	
1	18	
1.5	16	
2.5	14	
4	12	

The contacts are supplied in the silver or gold plated version. Male contacts in the "advanced" (shortened contact) version can also be supplied.

40A max contacts

conductor section (mm ²)	AWG	identification
1,5	16	Ø hole 1,75 mm
2,5	14	Ø hole 2,25 mm
4	12	Ø hole 2,85 mm
6	10	Ø hole 3,5 mm

The contacts may be supplied silver plated only

general

standard version



description

This series has been developed for application in electric and electronic machinery, control units, electric panels, control equipment, industrial environments, and in general, wherever a sectional and reliable connection is required for power and signal circuits. The inserts of the CMCE series (excepting the 16+2 poles) and of the CMSE series may use standard enclosures also for uses of up to 830V.

UL certified for USA and Canada for NEMA 4, NEMA 4X and NEMA 12 protection ratings, printed on the packaging. IP65, IP66 and IP69K protection ratings (IP44 and IP67 for CK and MK series).

Note: the enclosures are currently printed with the wording **IP65**.

Characteristics of the materials used:

CK, MK and CQ series

- in self-extinguishing grey RAL 7035 or black thermoplastic material for insulating enclosures (in the CQ version, only available in black) or metallic enclosures
- metallic enclosures with epoxy-polyester powder coating
- gaskets in anti-aging, oil-resistant, grease-resistant and fuel-resistant vinyl nitrile elastomer
- monoblock locking device in stainless steel or galvanised stainless steel for metallic enclosures
- monoblock locking device in self-extinguishing thermoplastic material for insulating enclosures

CZ, CH, CA and MZ, MH, MA, MF, MZF series

- In die-cast aluminium alloy
- with epoxy-polyester powder coating
- gaskets in anti-aging, oil-resistant, grease-resistant and fuel-resistant vinyl nitrile elastomer
- locking device with levers, springs and pegs in stainless steel
- monoblock lever handles in stainless steel (for CZ and MZ enclosures)
- lever handles in self-extinguishing thermoplastic material reinforced with glass fibres, UL approved (for CH, CA and MH, MA enclosures)

insulated 830V version



description

Applications as for the standard version. The enclosures do not have tabs and allow the insertion of inserts with rated voltage up to 830V (series CME). The enclosures contain supplementary insulating strips inside.

UL certified for USA and Canada for NEMA 4, NEMA 4X and NEMA 12 protection ratings, printed on the packaging. IP65, IP66 and IP69K protection ratings.

Note: the enclosures are currently printed with the wording **IP65**.

Characteristics of the materials used:

CM, CMA and MM, MMA, MMF series

- In die-cast aluminium alloy
- with epoxy-polyester powder coating
- gaskets in anti-aging, oil-resistant, grease-resistant and fuel-resistant vinyl nitrile elastomer
- locking device with levers, springs and pegs in stainless steel
- lever handles in self-extinguishing thermoplastic material reinforced with glass fibres, UL approved
- supplementary insulation inside enclosures

Changeover from Pg threads to M metric threads

After 31st December 1999, the German safety standard DIN VDE 0619 (1987-09) and the standards it refers to - DIN 46319 for dimensions with metric threads and DIN 46320 (T1-T4), DIN 46255 and DIN 46259 for dimensions with Pg threads (Pg= Panzerrohr-Gewinde: literally "threads for armoured pipes") - were withdrawn and European standard EN 50262 "Metric cable grippers for electrical installations" has been in force since 1st January 2000. This standard defines the new sizes with metric threads for cable grippers according to EN 60423 and establishes the safety prescriptions. Conversely, it does not specify the dimensions, such as the size of the tightening wrench, the diagonal dimension, or the dimensions of the tightness seals, as was the case in the withdrawn DIN for Pg cable grippers.

The standard came definitively into force on 1st April 2001, when the contrasting national standards were withdrawn. It is valid in all member countries of CENELEC (European Electrical Standardisation Committee) and its publication has led to a broadening of the supply of enclosures for multi-pole connectors for industrial use, to include new enclosure versions with cable entry suitable for metric cable grippers. Cable gripper producers have introduced the new metric series to add to the Pg size series, to gradually replace the latter type. The transition period indicated in the new standard should have ended on 1st March 2001, after which date the use of entry devices for Pg cables and, as a result, enclosures with Pg thread, should have ended in new installations. Nevertheless, both the cable entry devices and the relevant enclosures with Pg thread, may continue to be used as spare parts. For the CE marking of these items, observance of the safety conditions specified by the Low Voltage Directive is sufficient. To distinguish mobile and fixed wall-mounted enclosures with metric outlets from the relevant Pg versions (marked with a C pre-code), the ILME metric types are marked with an M pre-code.

The transposition table below indicates the correspondence rule adopted in most cases by ILME for creating the new metric versions.

Transposition Pg → metric

Pg	metric
Pg 11	M 20
Pg 13.5	M 20
Pg 16	M 20
Pg 21	M 25
Pg 29	M 32
Pg 36	M 40
Pg 42	M 50

180 °C version



description

This series has been developed for industrial applications where the ambient temperatures are particularly harsh (from -40 °C to +180 °C). The enclosures do not have any internal tabs and allow insertion of the CME inserts. These enclosures have supplementary insulating strips inside. These enclosures are for use with inserts in self-extinguishing thermoplastic material (PPS polyphenylene sulphide). This version is distinguished by the red colour of the enclosures.

UL certified for USA and Canada for NEMA 4, NEMA 4X and NEMA 12 protection ratings, printed on the packaging. IP65, IP66 and IP69K protection ratings.

Note: the enclosures are currently printed with the wording IP65.

Characteristics of the materials used:

CZ..R, CH..R, CA..R and MZ..R, MH..R, MA..R series

- in die-cast aluminium alloy
- chromate treated die cast treatment
- coated with special thermoset powder with high resistant to high temperatures
- gaskets in anti-aging fluoro elastomer
- locking device with levers, springs and pegs in stainless steel
- monoblock levers in stainless steel (for CZ..R, CH..R 48 and MZ..R, MH..R 48 versions)
- lever handles in aluminium with special die-cast coating (for CH..R 10, 16, 24 and MH..R 10, 16, 24 versions)
- supplementary insulation inside enclosures

version for aggressive environments



description

This series has been developed for industrial applications with particularly aggressive external agents (e.g. salt atmospheres or ambients, etc.). The enclosures do not have any internal tabs and allow insertion of the CME inserts. These enclosures have supplementary insulating strips inside. The version can easily be identified by the green colour of the enclosures.

UL certified for USA and Canada for NEMA 4, NEMA 4X and NEMA 12 protection ratings, printed on the packaging. IP65, IP66 and IP69K protection ratings.

Note: the enclosures are currently printed with the wording IP65.

Characteristics of the materials used:

CK..W and MK..W series

- chromate treated die cast treatment
- coated with epoxy-polyester powder
- gaskets in fluoro elastomer
- monoblock locking device in stainless steel

CZ..W, CH..W, CA..W series and MZ..W, MH..W, MA..W

- in die-cast aluminium alloy
- chromate treated die cast treatment
- coated with epoxy-polyester powder
- gaskets in anti-aging fluoro elastomer
- locking device with levers, springs and pegs in stainless steel
- pegs in stainless steel
- monoblock levers in stainless steel (for CZ..W and MZ..W enclosures)
- lever handles in self-extinguishing thermoplastic material reinforced with glass fibres, UL approved (CH..W, CA..W and MH..W, MA..W versions)
- supplementary insulation inside enclosures

EMC version



description

This series has been developed for industrial applications that require electromagnetic compatibility (EMC, Electromagnetic Compatibility), in accordance with the European standards that regulate the emission and immunity of the equipment.

UL certified for USA and Canada for NEMA 4, NEMA 4X and NEMA 12 protection ratings, printed on the packaging. IP65, IP66 and IP69K protection ratings.

Note: the enclosures are currently printed with the wording IP65.

Characteristics of the materials used:

CK..S and MK..S series

- chromate treated die cast treatment with high surface conductivity
- special gaskets in highly conductive material
- monoblock locking device in stainless steel

CZ..S, CH..S, CA..S and MZ..S, MH..S, MA..S series

- in die-cast aluminium alloy
- chromate treated die cast treatment with high surface conductivity
- special gaskets in highly conductive material
- locking device with levers, springs and pegs in stainless steel
- lever handles in self-extinguishing thermoplastic material reinforced with glass fibres, UL approved

high protection IP68 version

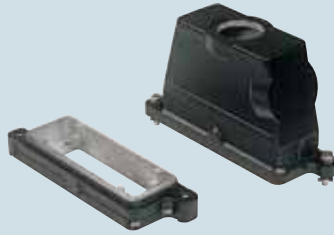

description

For applications in the railway sector and whenever the following characteristics are demanded: high pressure, impact and corrosion resistance, in protection class IP68. Moreover, they provide good electromagnetic screening. The IP68 protection class marked on the enclosure is guaranteed subject to expert installation and use of cable entry devices with equal or better characteristics.

UL certified for USA and Canada for NEMA 4, NEMA 4X and NEMA 12 protection ratings, printed on the packaging.
IP69K protection rating for tightness to pressurized water jets.

Characteristics of the materials used:

CG and MG series

- in aluminium alloy corrosion resistant
- chromate treated die cast treatment
- with black epoxy powder coating
- gaskets in anti-aging, oil-resistant, grease-resistant and fuel-resistant vinyl nitrile elastomer
- closure with stainless steel hex-head or bayonet screws.

single lever central position version



description

This series was specifically made for industrial applications with limited installation space. These enclosures can be installed, placed side-by-side and handled in a single operation. Furthermore, the lever's shape reduces the effort required to uncouple the inner fittings.

Characteristics of the materials used:

CH..YC, CA..YC and MA..YC, CA..YX and MF..YX series

- in die-cast aluminium alloy
- with epoxy-polyester powder coating
- gaskets in anti-aging, oil-resistant, grease-resistant and fuel-resistant vinyl nitrile elastomer
- locking device with single stainless steel lever

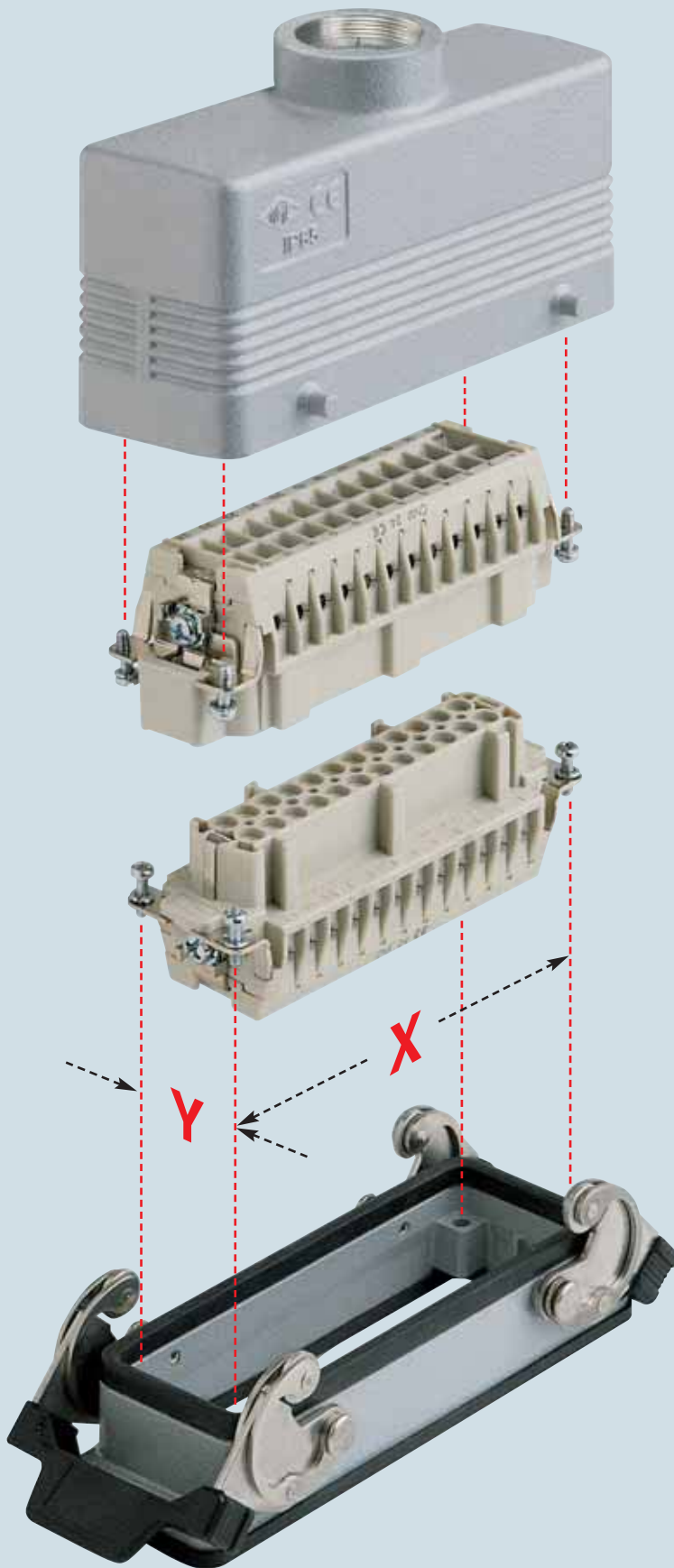

Identification of the enclosures

There are a large number of connector inserts and relative enclosures and so the search for a correct combination may be complex.

As well as the normal item part No., to facilitate this operation a further identification parameter has been introduced in this catalogue, the "size" value.

As indicated in the illustration on the left and in the table below the size value refers to the screw fixing centre distances which constitute a unique element since they are common to both the inserts and the enclosures.

All the pages that illustrate combinable articles (inserts and enclosures) carry references as per the examples illustrated on the opposite page.

Following is a table that shows all the sizes of the enclosures and the dimensions of the housings where the inserts will be fastened.

enclosure "size" identification	housing space for inserts with screw fixing centre distance x-y
"21.21"	(21 x 21 mm)**
"32.13"	32 x 13 mm
"49.16"	49.5 x 16 mm
"66.16"	66 x 16 mm
"66.40"	66 x 16 mm (2 inserts)
"44.27"	44 x 27 mm
"57.27"	57 x 27 mm
"77.27"	77.5 x 27 mm
"104.27"	104 x 27 mm
"77.62"	77.5 x 27 mm (2 inserts)
"104.62"	104 x 27 mm (2 inserts)

** with dimensions relative to the size of the sectioned inserts the screw fixing centre distance cannot be given because they only have one screw.

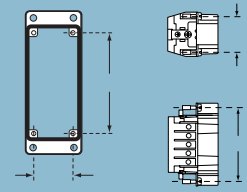
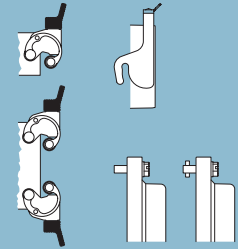
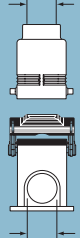
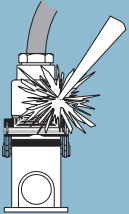
				
enclosures size	for inserts with screw fixing centre distance	locking device	Pg or Metric cable clamp diameter *	coupled enclosures degree of protection
	mm	type	min ÷ max	
21.21	---	single	Pg 11 M 20	IP44, IP66, IP67, IP68, IP69K
32.13	32 x 13	single	Pg 16 ÷ 21	IP66, IP67, IP69K
49.16	49.5 x 16	single	Pg 13.5 ÷ 21 M 20 ÷ 25	IP66
66.16	66 x 16	single	Pg 16 ÷ 21 M 20 ÷ 25	IP66
66.40	66 x 16 (x2)	double	Pg 21 ÷ 29 M 25 ÷ 40	IP66
44.27	44 x 27	single or double single with central lever screw or bayonet	Pg 13.5 ÷ 29 M 20 ÷ 40	IP66, IP68, IP69K
57.27	57 x 27	single or double single with central lever screw or bayonet	Pg 16 ÷ 29 M 20 ÷ 40	IP66, IP68, IP69K
77.27	77.5 x 27	single or double single with central lever screw or bayonet	Pg 21 ÷ 36 M 25 ÷ 50	IP66, IP68, IP69K
104.27	104 x 27	single or double single with central lever screw or bayonet	Pg 21 ÷ 36 M 25 ÷ 50	IP66, IP68, IP69K
77.62	77.5 x 27 (x2)	single or double	Pg 29 ÷ 42 M 32 ÷ 50	IP66, IP69K
104.62	104 x 27 (x2)	single	Pg 29 ÷ 42 M 32 ÷ 50	IP66, IP69K

* on request, NPT thread

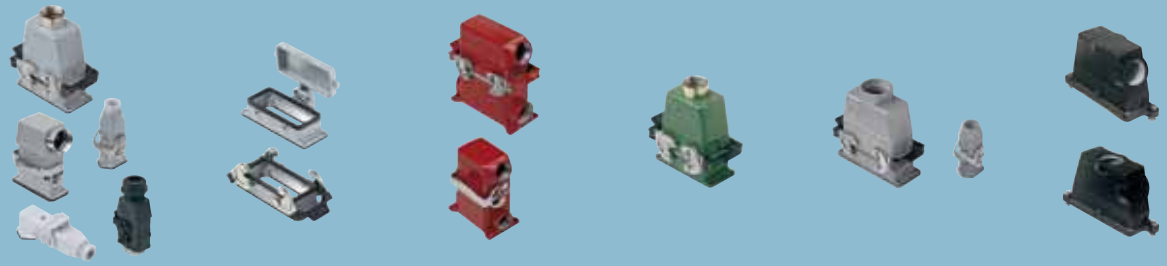

combinations

enclosures size	standard	insulated 830V	enclosures versions			
	pages	pages	180 °C pages	for aggressive environments pages	EMC pages	high protection IP68 pages
21.21	✓ 153 ÷ 156	✗	📎 on request	✓ 157	✓ 158	✓ 246 ÷ 247
32.13	✓ 160 ÷ 161	✗	✗	✗	📎 on request	✗
49.16	✓ 162 ÷ 163	✗	📎 on request	✓ 164	✓ 165	✗
66.16	✓ 166 ÷ 167	✗	📎 on request	✓ 168	✓ 169	✗
66.40	✓ 171 ÷ 173	✗	✗	✓ 174	✗	✗
44.27	✓ 176 ÷ 179	✗	✓ 180	✓ 181	✓ 182	✓ 248 ÷ 252
57.27	✓ 184 ÷ 188	✓ 189 ÷ 193	✓ 194	✓ 195	✓ 196	✓ 248 ÷ 252
77.27	✓ 198 ÷ 202	✓ 203 ÷ 207	✓ 208	✓ 209	✓ 210	✓ 248 ÷ 252
104.27	✓ 212 ÷ 216	✓ 217 ÷ 221	✓ 222	✓ 223	✓ 224	✓ 248 ÷ 252
77.62	✓ 226 ÷ 229	✓ see standard enclosures	✗	✓ 230	✗	✗
104.62	✓ 232	✓ see standard enclosures	✓ 233	✓ 234	✗	✗

- ✓ = normal production
- 📎 = may be supplied on request, contact our sales offices
- ✗ = not available at present

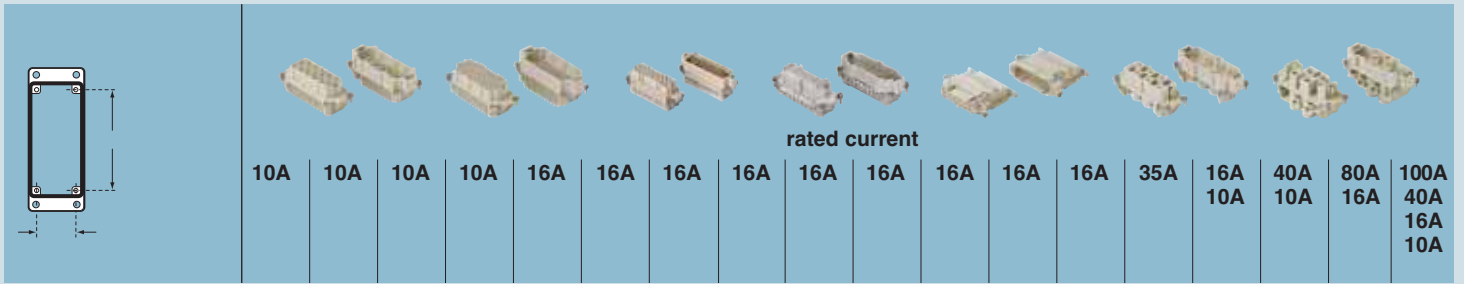

catalogue index		inserts series																	
enclosures size	pages	CK, CKS	CD	CT, CTS	CDD	CDA, CDC	CQ	CQE	CN	CCE	CNE, CSE, CSS	CTE, CTSE, CT	CME	CMSE, CMCE	CP	CX	CX	CX	MIXO

		inserts polarity + ⊕																	
21.21	153 ÷ 159	3 4	7 8#				12 5												
32.13	160 ÷ 161						8 4/2												
49.16	162 ÷ 165		15			10													①*
66.16	166 ÷ 169		25		38	16													
66.40	171 ÷ 174		50		76	32													
44.27	176 ÷ 182				24			10	6	6	6	6*							②*
57.27	184 ÷ 196				42			18	10	10	10	10*	3+ ²	3+ ²		8/24			③*
77.27	198 ÷ 210		40	40*	72			32	16	16	16	16*	6+ ²	6+ ²	6		6/36 12/2	4/0 4/2	④*
104.27	212 ÷ 224		64	64*	108			46	24	24	24	24*	10+ ² 16+ ²	10+ ² 16+ ² *				4/8	⑥*
77.62	226 ÷ 230		80		144			64	32	32	32	32*	12+ ⁴	12+ ⁴	12				⑧*
104.62	232 ÷ 234		128		216			92	48	48	48	48*	20+ ⁴ 32+ ⁴	20+ ⁴ 32+ ⁴ *					⑫*
inserts catalogue index	pages	36 and 37	39 ÷ 47	50 and 51	53 ÷ 60	66 ÷ 71	62 ÷ 65	74 ÷ 79	80 ÷ 85	86 ÷ 96	87 ÷ 103	106 ÷ 113	115 ÷ 125	114 ÷ 125	127 and 128	129	130 and 131	132 and 133	124 ÷ 131

- # = polarity without earth contact
- * = may be mounted exclusively in bulkhead housings
- ⊙* = number of modular inserts that may be inserted in the enclosures
- ★ = polarity unavailable in the CMSE version

The polarity values in "red" are obtained using double inserts
 The polarity values in "green" must be mounted exclusively in insulated enclosures (CM - CMA and MM - MMA series)
 The polarity values indicated as exponentials in the CME, CMCE and CMSE inserts identify the pilot contacts for advanced opening

combinations

general

load curves

The current carrying capacity possible in the connectors is variable. It reduces with the increase of the number of poles and the temperature of the environment in which the connector is installed and is determined by the thermal properties of the materials used for the contacts and the insulating parts as well as by the type of conductor used. The current carrying capacity is obtained from the load curves which are constructed according to standard IEC 60512-5-2 for currents circulating simultaneously in all poles.

The limit current curves express current values that determine the achievement of the highest limit temperature of the materials. The choice of the permanent load applicable on the contacts must be made within the field of operation possible delimited by the above curves.

Since the use of the connectors at the limit of the values of their characteristics is not recommended, the base curve is derated. The reduction of the load curves to 80% defines the correction curve where both the maximum contact resistance permissible and the inaccuracy of the temperature measurements are sufficiently borne in consideration. The correction curve represents the final limit current curve (load curve) as defined by standard IEC 60512-5-2. It therefore bears in consideration the difference between the various connectors, as well as errors in the temperature measurements.

All the load curves presented herebelow include the corrections.

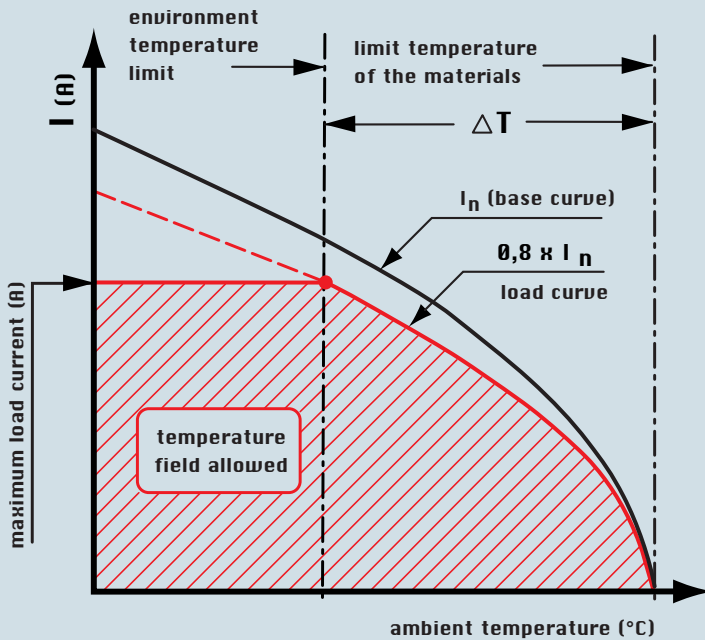

Legend:

Maximum load current (A): value for which the connector reaches the limit temperature of the material at the environmental temperature, intersected on the load curve.

Limit temperature of the materials: value determined by the characteristics of the materials used. The sum of the environmental temperature and the increase of the simbolo ΔT temperature caused by the passage of the current must not exceed the limit temperature of the materials.

Environment temperature limit: the environmental conditions must not exceed this value. It may be know and determines the maximum load current, or may be obtained directly from the load curve.

Base curve: set of current and temperature values obtained from laboratory tests and influenced by the connector's characteristics (number of poles, construction shape, thermal conductivity of the materials, etc.) and the section of the conductor used.

Load curve (limit current curve): obtained from the base curve via the safety coefficient.

ΔT (overtemperature): temperature increase produced by a permanent current circulating through all the poles of a connector coupling; difference between the limit temperature of the materials and the environmental temperature obtained on the limit current curve.

CK series - CKS series

curves

diagram CK 03 poles

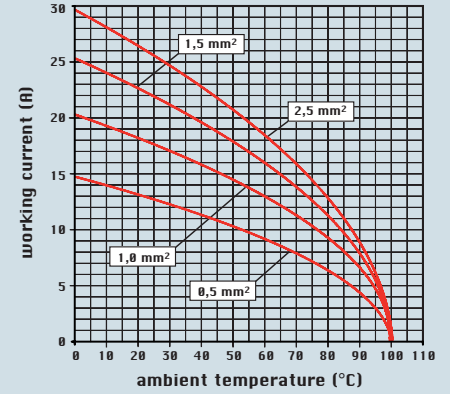

diagram CK 04 poles

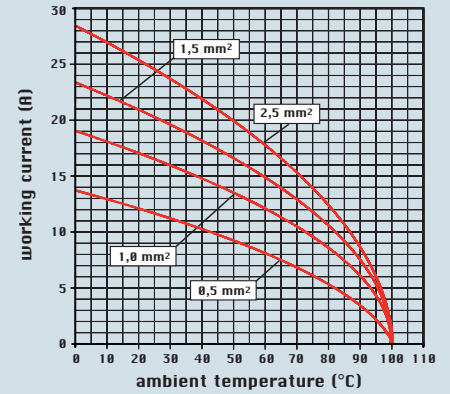

diagram CKS 03 poles

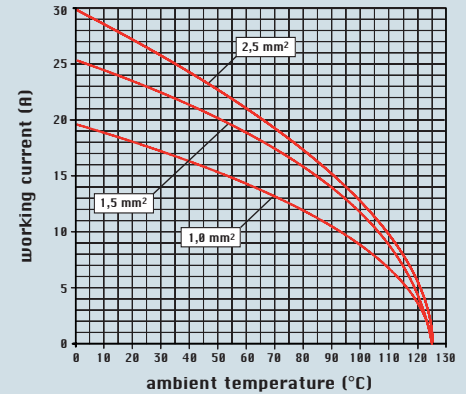
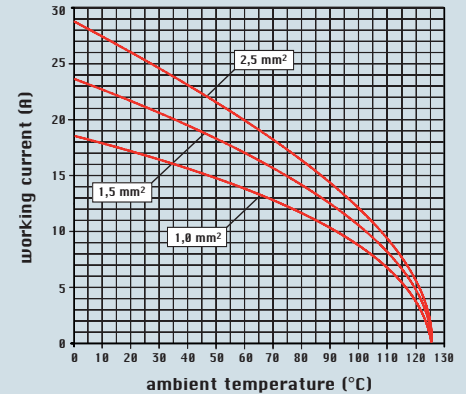
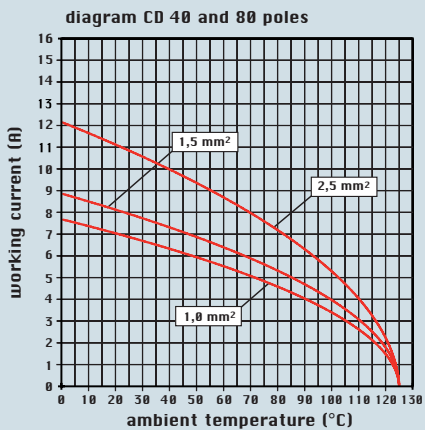
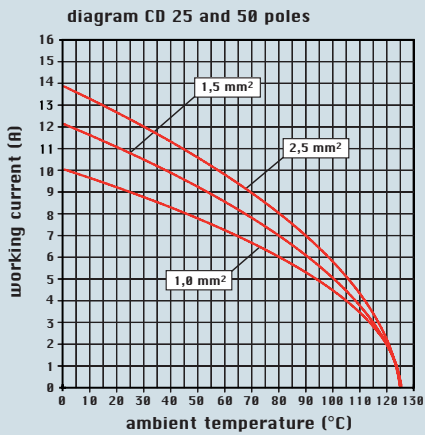
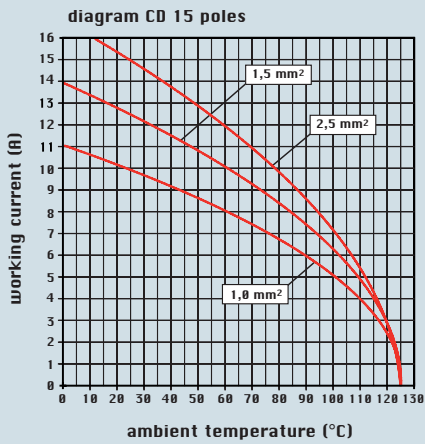
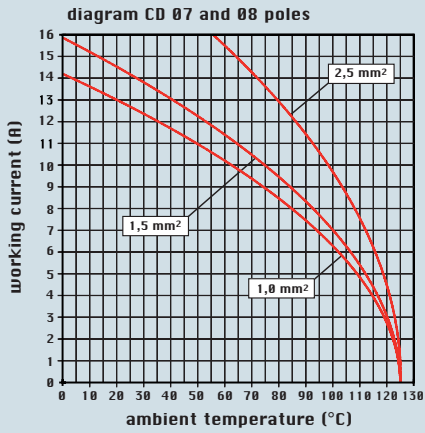

diagram CKS 04 poles



CD series

curves



CD series - CT (10A) series

CDD series

curves

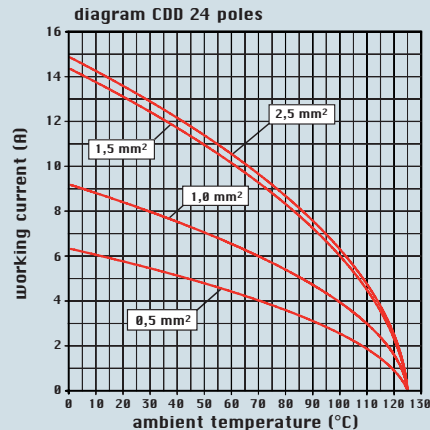
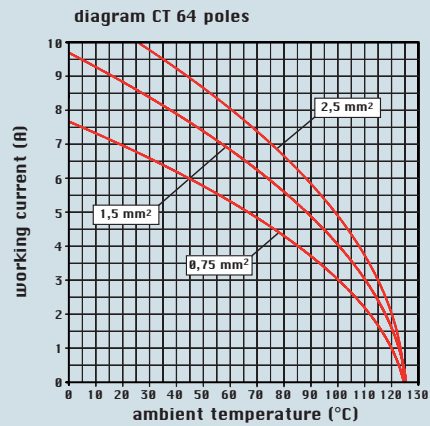
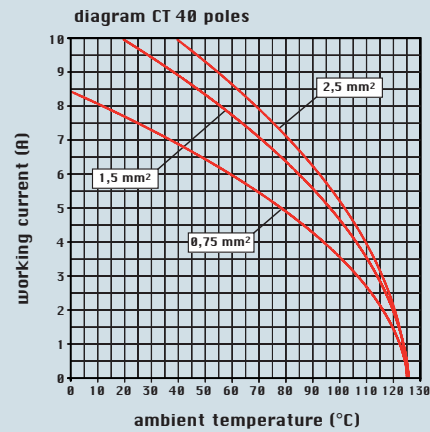
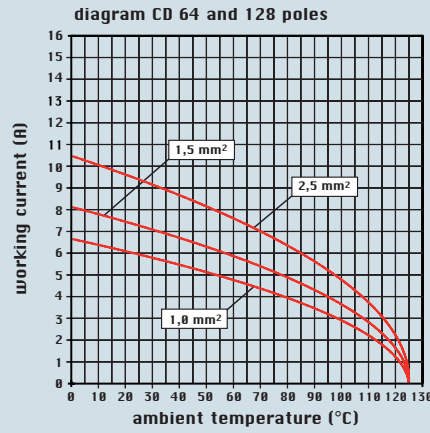

CDD series

curves

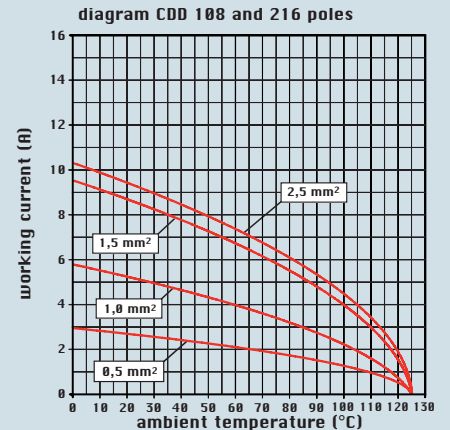
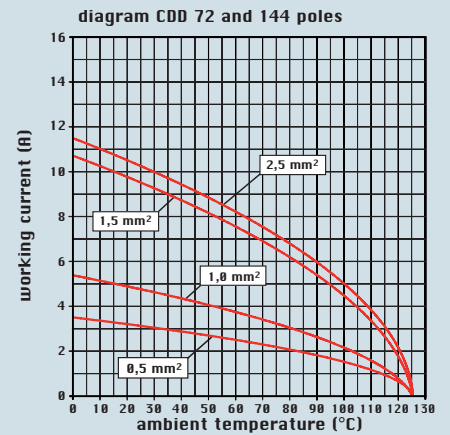
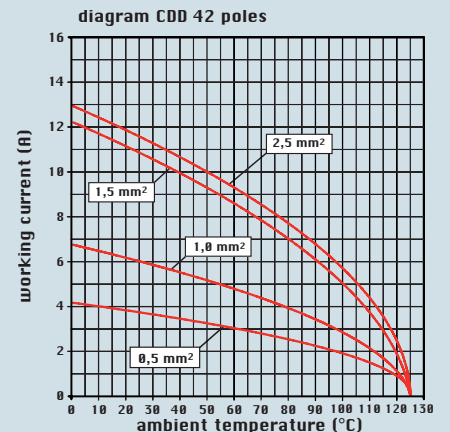
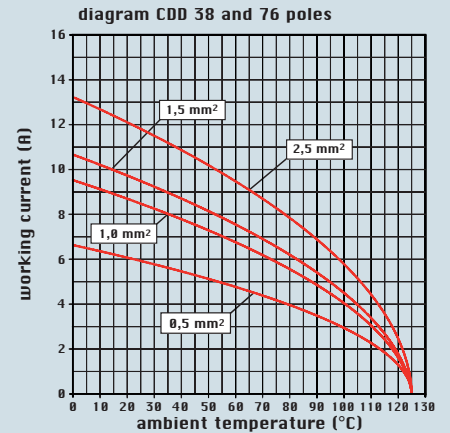

CQ series

curves

load curves

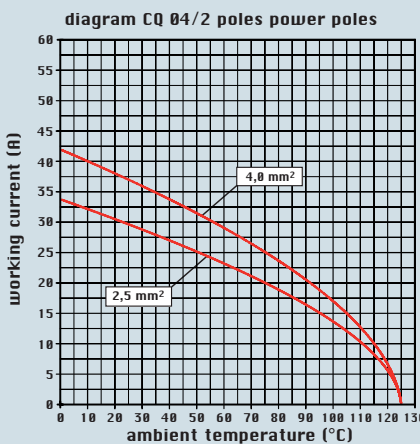
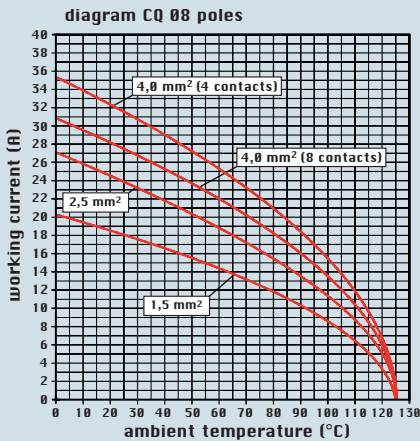
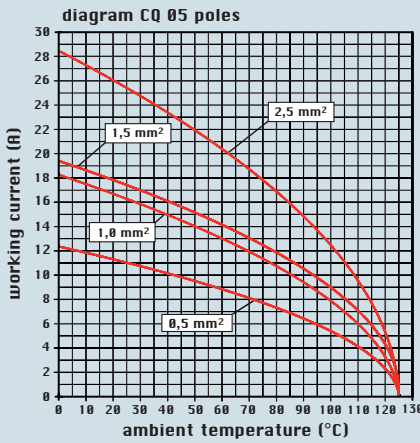
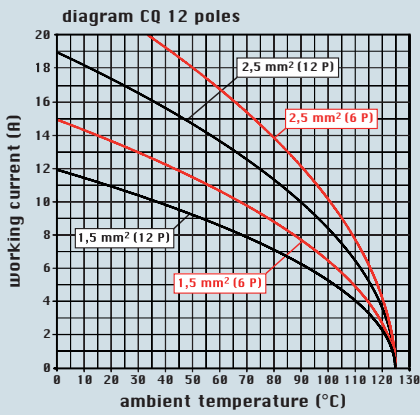

CDA/CDC series

curves

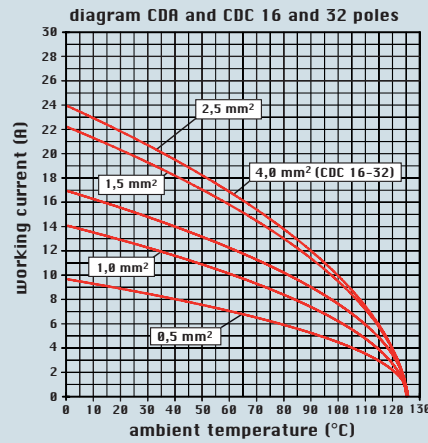
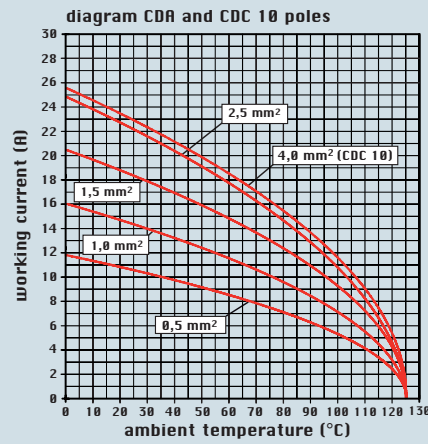

CQE series

curves

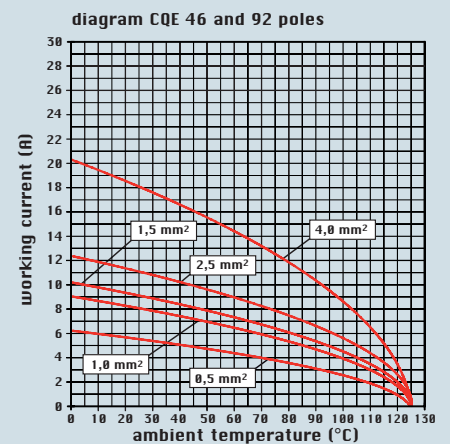
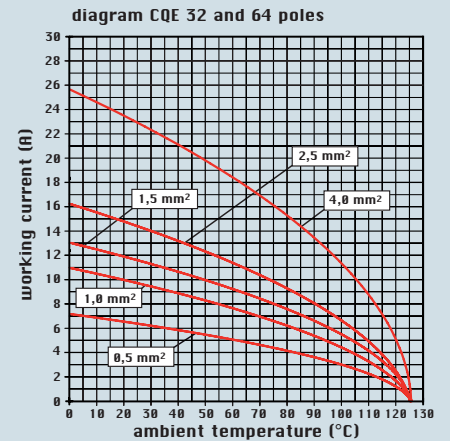
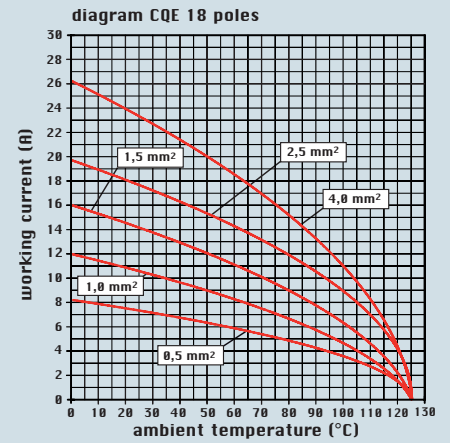
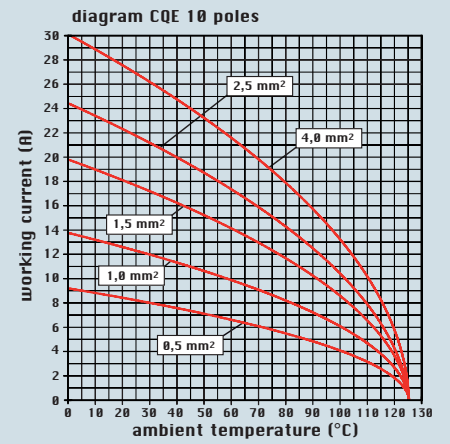

CN, CNE and CCE series

curves

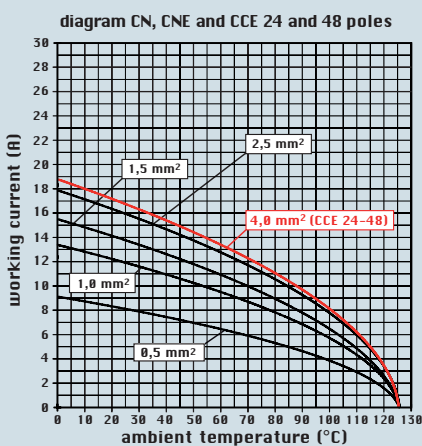
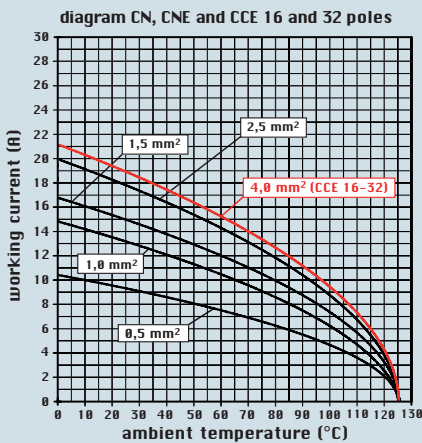
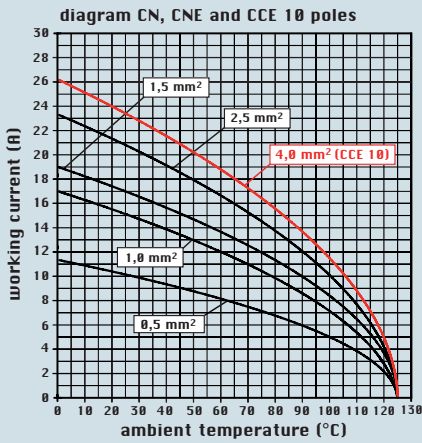
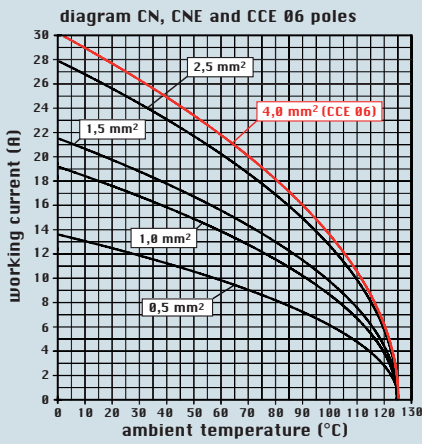

CSE series

curves

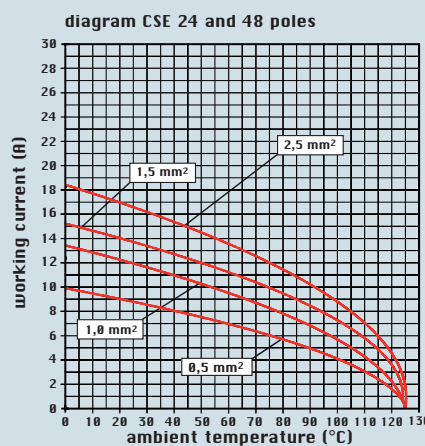
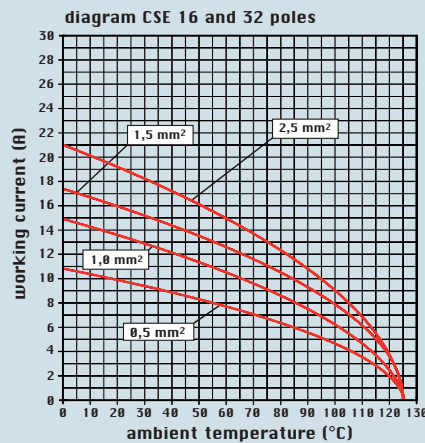
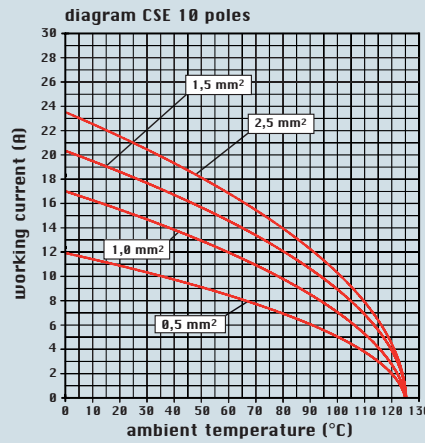
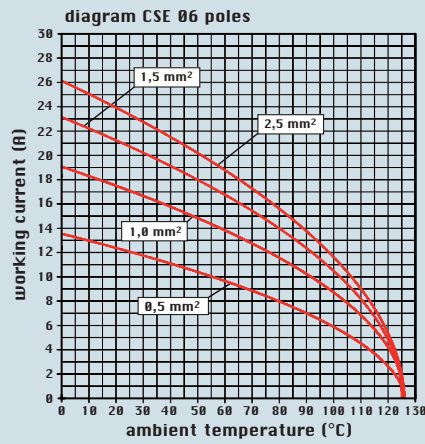

CSS series

curves

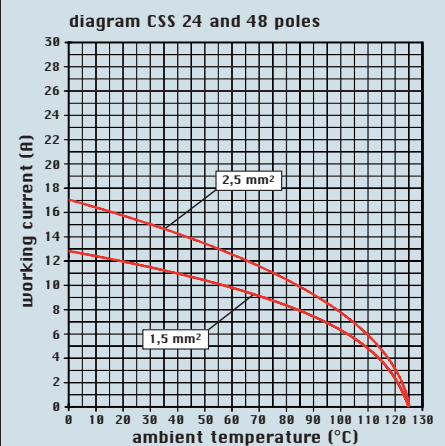
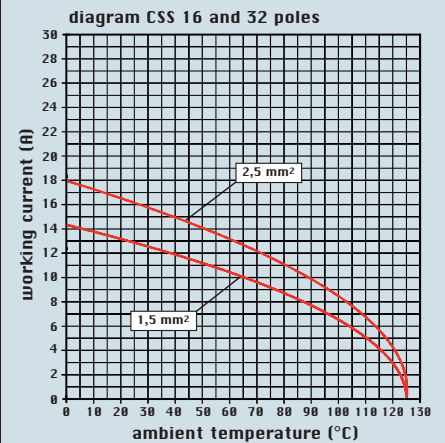
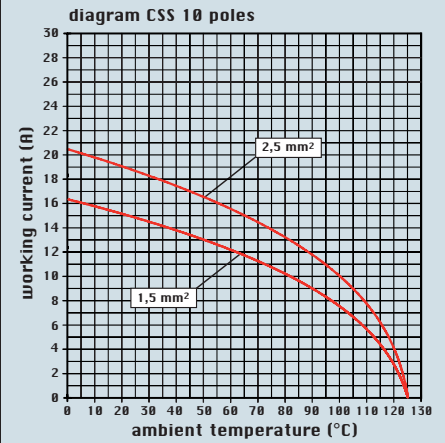
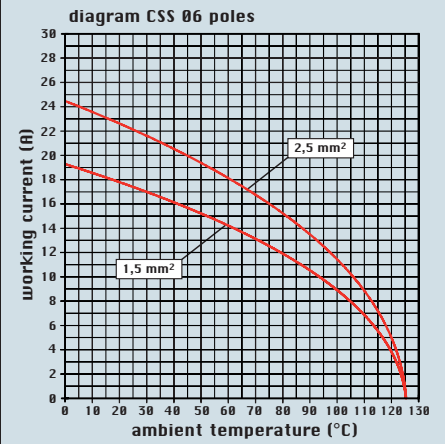

load curves

CTSE (16A) series

curves

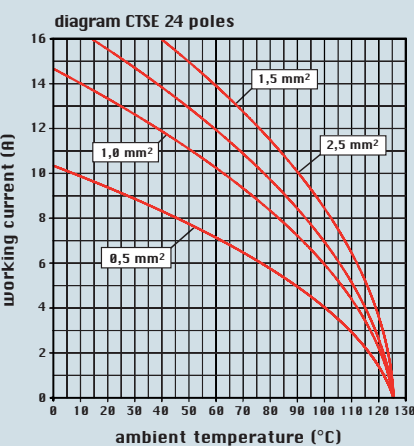
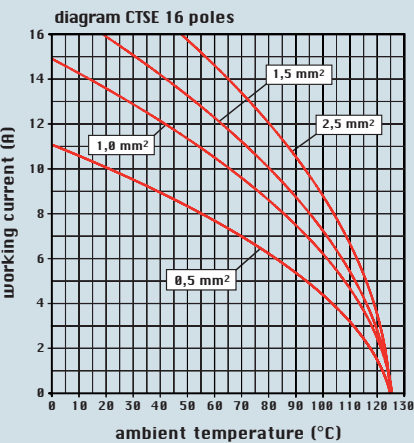
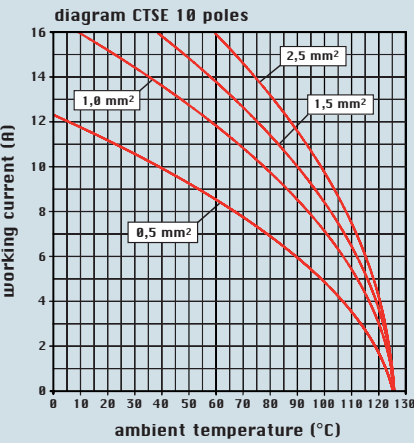
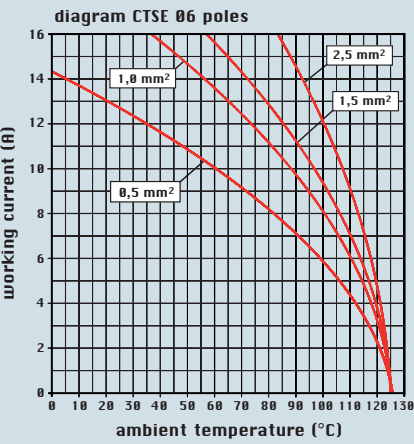

CMCE and CME series

curves

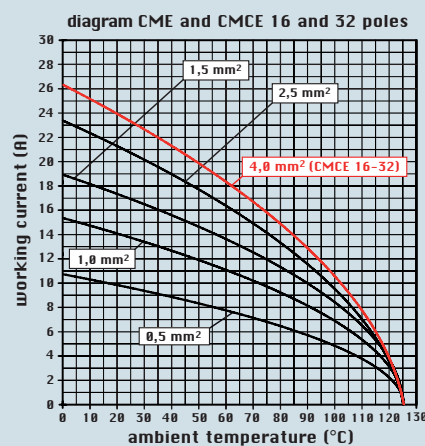
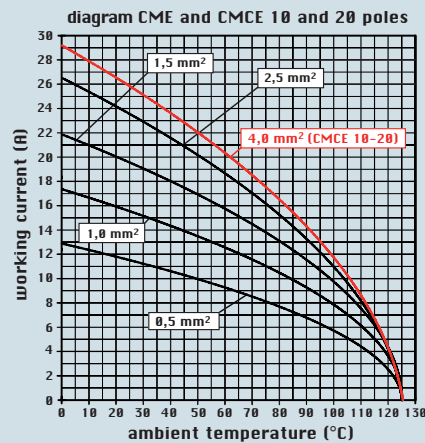
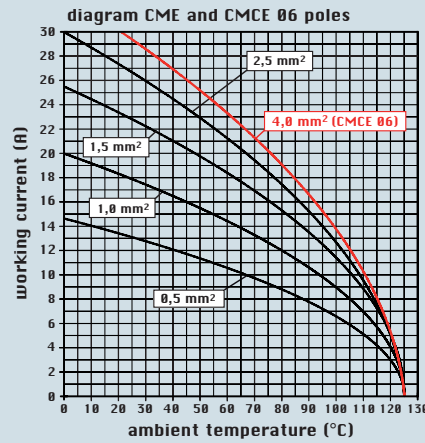
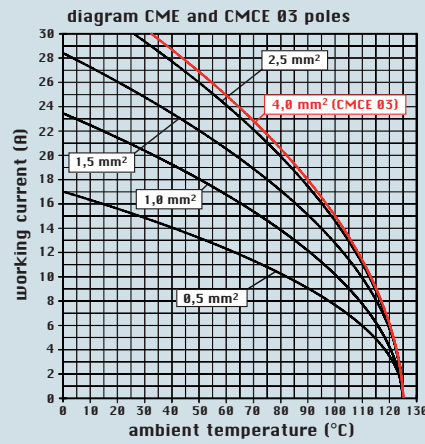

CMSE series

CP series

curves

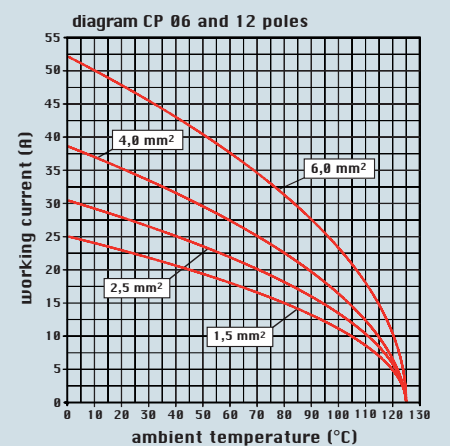
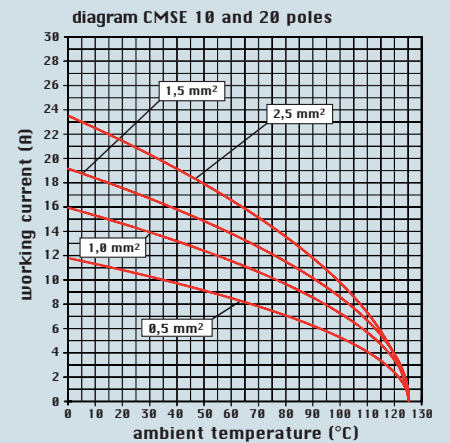
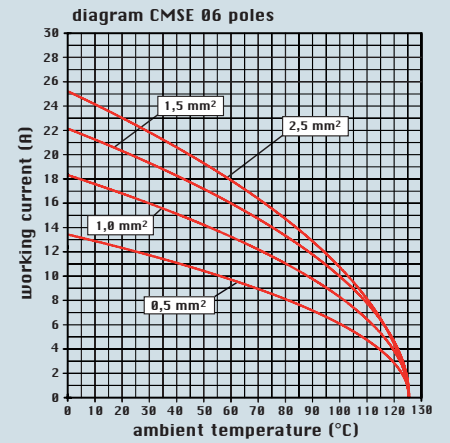
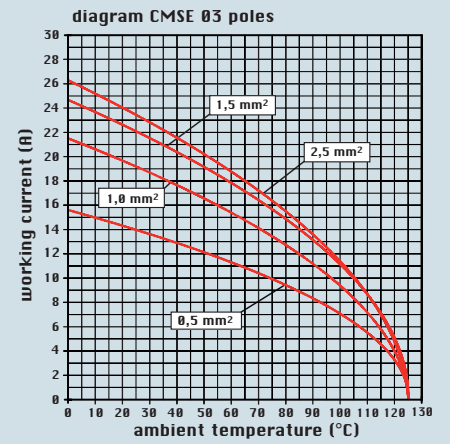

load curves

CX 8/24 series
CX 6/36 series

curves

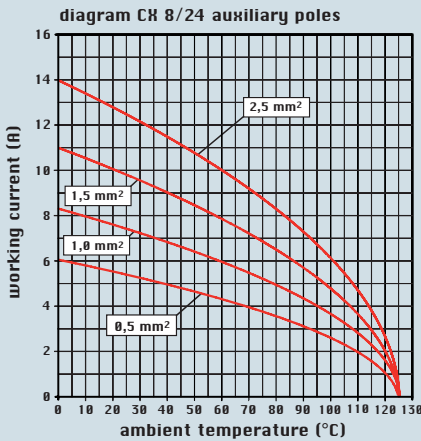
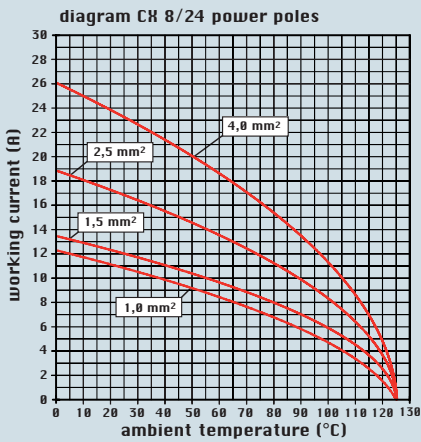

Note: for connector with power poles and auxiliary poles simultaneously loaded in the combinations

power poles	auxiliary poles
4.0 mm ²	2.5 mm ²
2.5 mm ²	1.5 mm ²
1.5 mm ²	1.0 mm ²
1.0 mm ²	0.5 mm ²

with power / auxiliary current ratios = 1.6 / 1

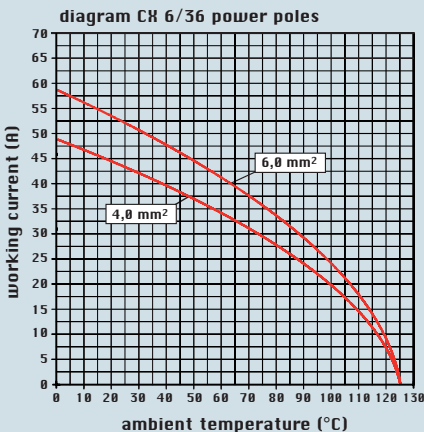

CX 12/2 series
CX 4/0 series

curves

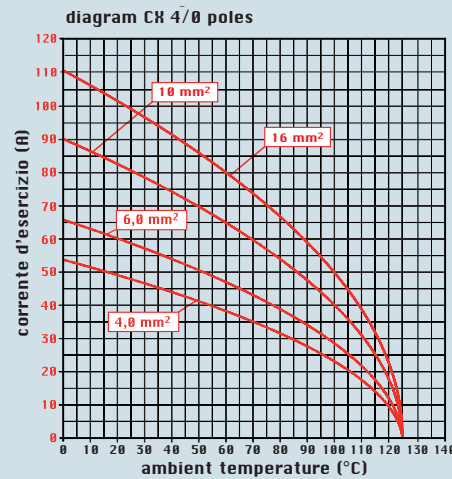
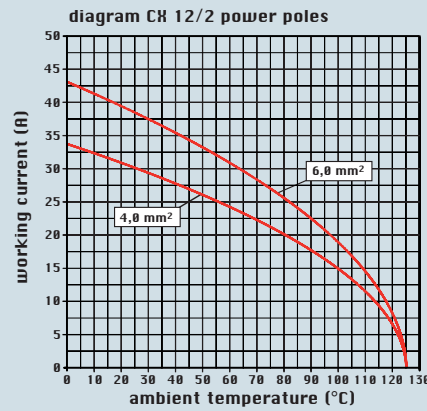

CX 4/2 series

curves

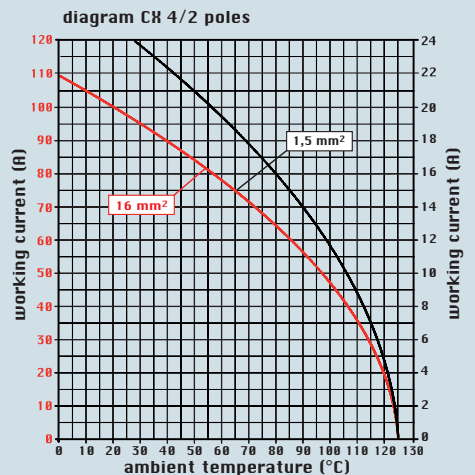
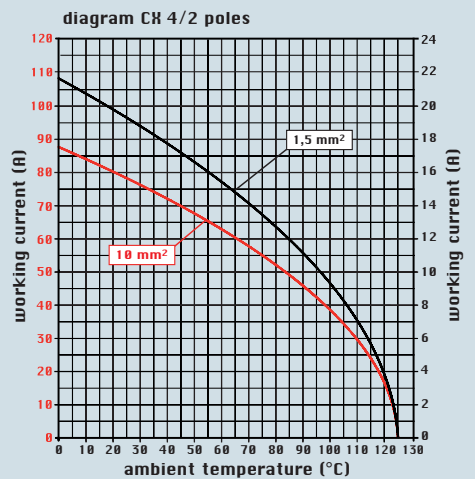
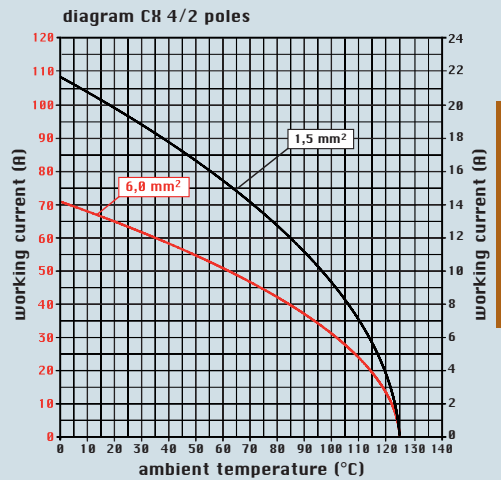

CX 4/8 series

curves

load curves

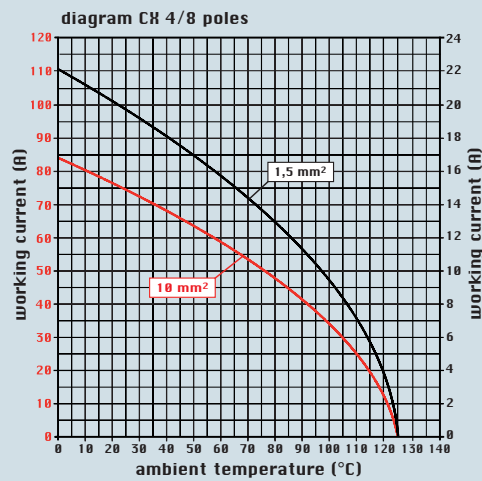
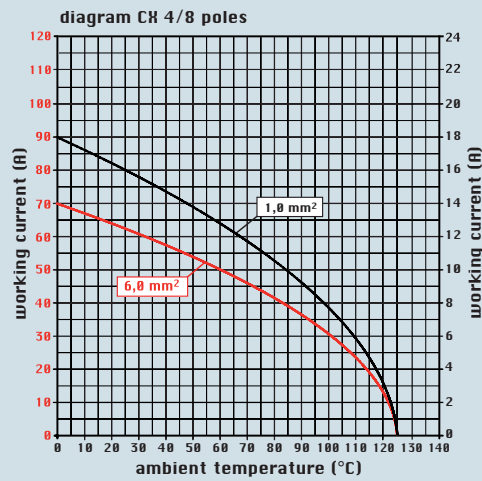
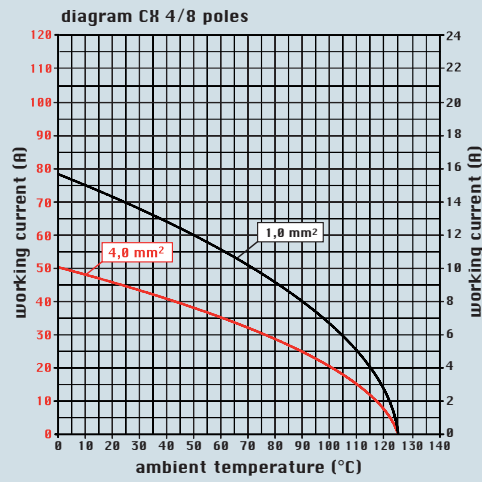

CX 4/8 series
MIXO (CX 02, CX 02 4A/B) series

curves

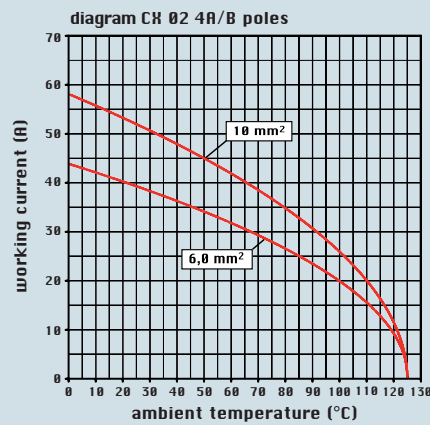
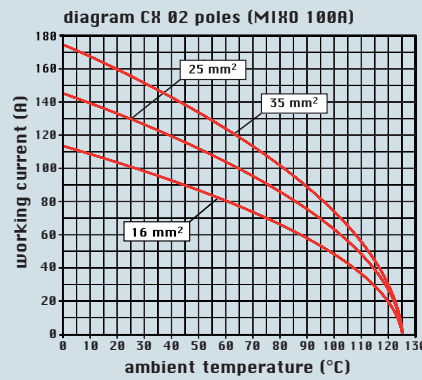
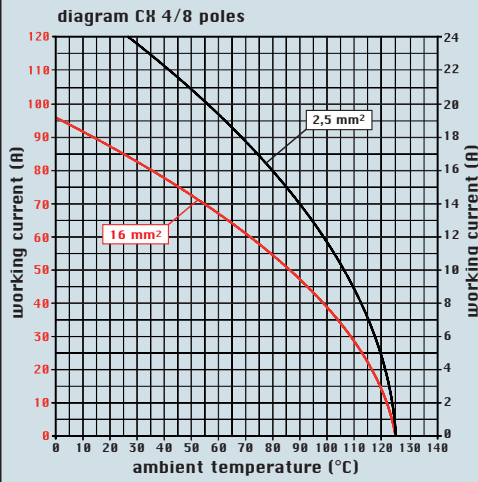

MIXO (CX 03, CX 05, CX 06) series

curves

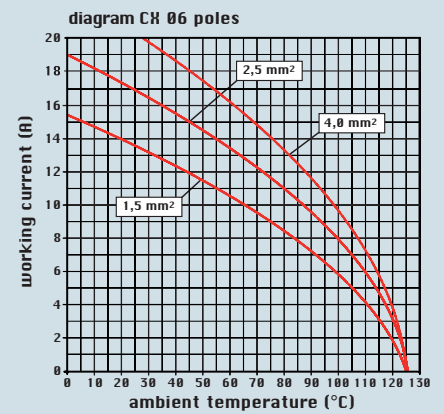
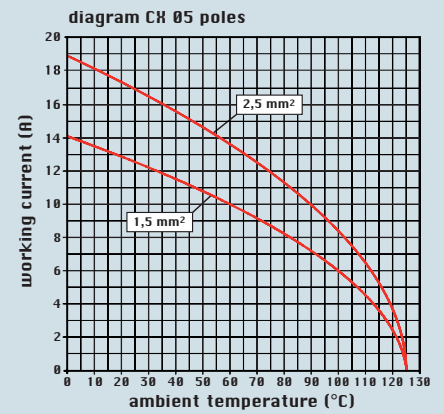
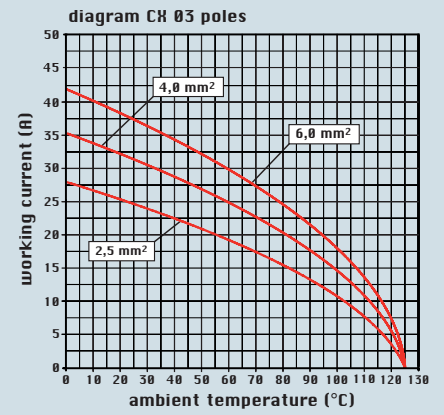

MIXO (CX 08, CX 12, CX 20) series

curves

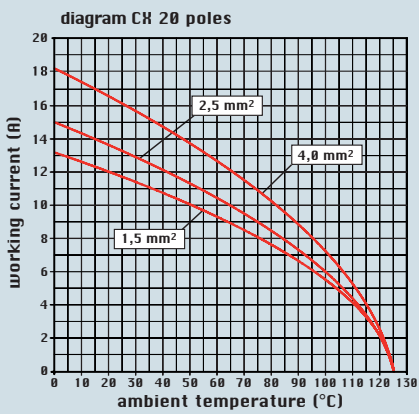
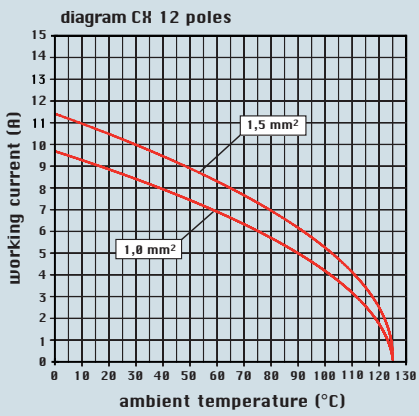
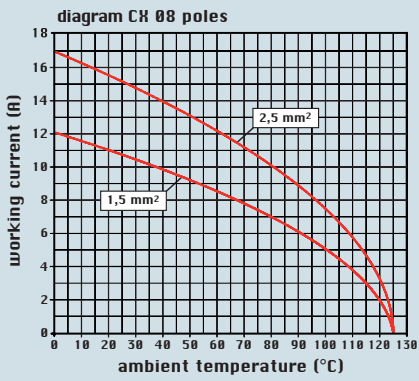

enclosures **size "21.21"**

- insulating type** page: 153 ÷ 154
- metallic type** page: 155 ÷ 156
- aggressive environments**..page: 157
- EMC** page: 158

- features according to EN 61984:
10A 250V 4kV 3
- UL, CSA, CCC, GL certified
- for maximum current load, see the insert load curve section on page 28
- inserts and enclosures for applications with temperatures up to 180 °C, available on request
- can be mated with CKS inserts

**inserts, 3 poles + ⊕
screw terminal connections**



**inserts, 4 poles + ⊕
screw terminal connections**



description	part No.	part No.	part No.	part No.
distinctive colour female inserts with female contacts ¹⁾ male inserts with male contacts	white CKF 03 CKM 03	black CKF 03 N CKM 03 N		
distinctive colour female inserts with female contacts ¹⁾ male inserts with male contacts			white CKF 04 CKM 04	black CKF 04 N CKM 04 N

¹⁾ the female inserts can be mounted into the straight bulkhead housings CK I from the rear

dimensions in mm

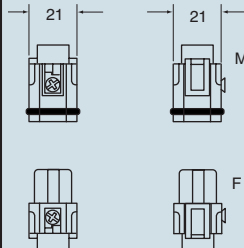

contacts side (front view)



- inserts for connectors with the following sections:
0.75 ÷ 2.5 mm² - AWG 18 ÷ 14
- torsion couple recommended for conductor fastening screws and stripping length see section feature of inserts on page 13

dimensions in mm

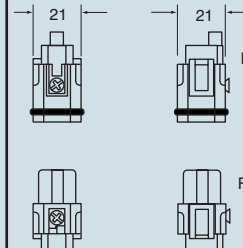

contacts side (front view)



- inserts for connectors with the following sections:
0.75 ÷ 2.5 mm² - AWG 18 ÷ 14
- torsion couple recommended for conductor fastening screws and stripping length see section feature of inserts on page 13

dimensions indicated are not binding and may be changed without notice

enclosures: size "21.21"

- insulating type page: 153 ÷ 154
- metallic type page: 155 ÷ 156
- aggressive environments..page: 157
- EMC page: 158

- features according to EN 61984:
10A 400V 4kV 3
- certifications: (UL), (CSA); the certifications shown in brackets are being applied for
- for maximum current load, see the insert load curve section on page 28
- can be mated with CK inserts

**inserts, 3 poles + ⊕
connection with spring terminal**



NEW

**inserts, 4 poles + ⊕
connection with spring terminal**



NEW

description	part No.	part No.
female inserts with female contacts male inserts with male contacts	CKSF 03 CKSM 03	
female inserts with female contacts male inserts with male contacts		CKSF 04 CKSM 04

connection with spring terminal

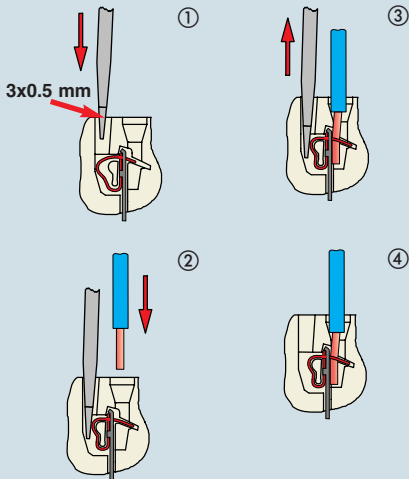

dimensions in mm

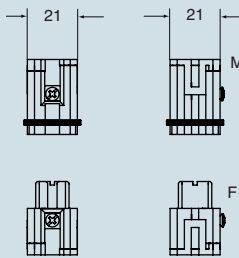

contacts side (front view)

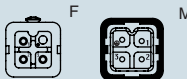

dimensions in mm

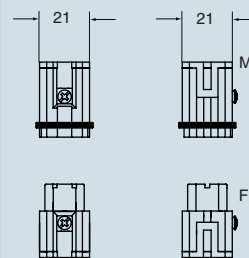

contacts side (front view)

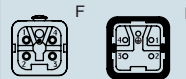

Rear top entry of wires for a more easier wiring

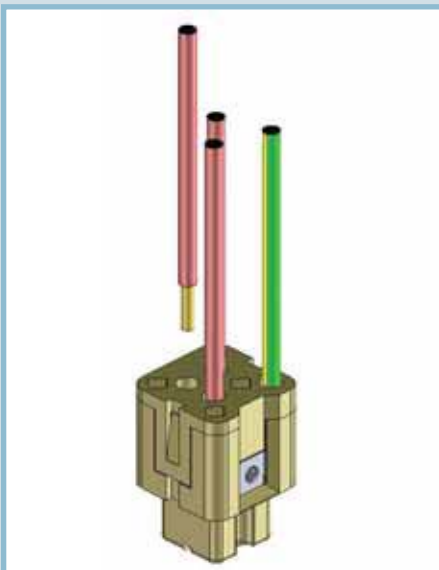

dimensions indicated are not binding and may be changed without notice

- inserts for wires with the following sections:
0.14 ÷ 2.5mm² - AWG 26 ÷ 14
for prepared wires
usable section: up to 1.5 mm² (AWG 16)
- stripping length see section feature of inserts on page 13

- inserts for wires with the following sections:
0.14 ÷ 2.5mm² - AWG 26 ÷ 14
for prepared wires
usable section: up to 1.5 mm² (AWG 16)
- stripping length see section feature of inserts on page 13

If all the contacts are used, the CD inserts series connectors may be used with voltages of up to 250V (first column) pollution degree 3 in accordance with the standard EN 61984.
 If the number of contacts is reduced and the contacts accordingly assigned, these connectors may be used with higher voltages. This is possible because the decrease in the number of contacts leads to an increase in the surface distance in the air. When the contacts are arranged as shown below, the inserts may be used for voltages of 500V (second column) pollution degree 3 in accordance with the standard EN 61984.

Legend:

- working contact
- without contact
- M = male insert
- F = female insert

for use up to 250V
 pollution degree 3

diagrams
 contacts side (front view)

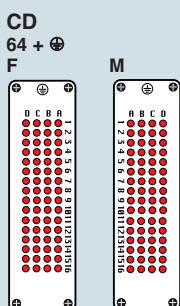
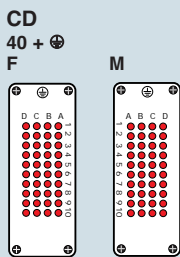
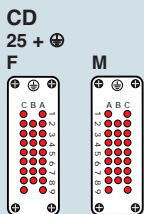
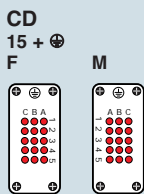
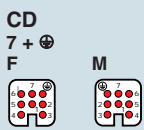

for use up to 500V
 pollution degree 3

diagrams
 contacts side (front view)

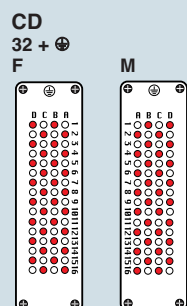
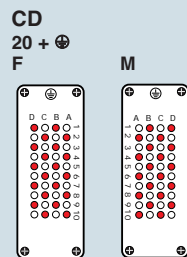
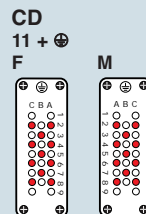
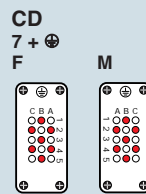
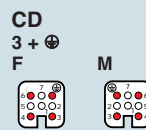

enclosures **size "21.21"**
 insulating type page: 153 ÷ 154

- features according to EN 61984:
10A 250V 4kV 3
- UL, CSA, CCC, GL certified
- for maximum current load, see the insert load curve section on page 29
- for applications requiring higher voltages, please see the special voltage application section on page 38
- for contact crimping instructions, please see the crimping tool section (10A contacts, CDF and CDM series) on pages 296, 300, 304, 306, 308
- coding pin with loss of a contact CR CP

inserts, crimp connections

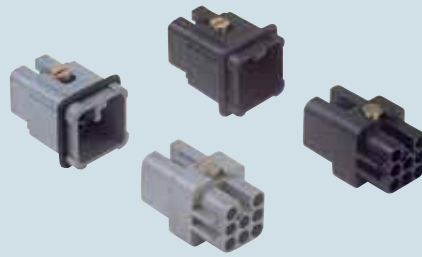

10A crimp contacts silver and gold plated



description	part No.	part No.	part No.	part No.
without contacts (to be ordered separately) female inserts for female contacts, grey and black ¹⁾ male inserts for male contacts, grey and black	grey CDF 07 CDM 07	black CDF 07 N CDM 07 N		
10A female contacts 0.14÷0.37 mm ² AWG 26÷22 identification No. 1 0.5 mm ² AWG 20 identification No. 2 0.75 mm ² AWG 18 identification No. ② 1 mm ² AWG 18 identification No. 3 1.5 mm ² AWG 16 identification No. 4 2.5 mm ² AWG 14 identification No. 5			silver plated C DFA 0.3 C DFA 0.5 C DFA 0.7 C DFA 1.0 C DFA 1.5 C DFA 2.5	gold plated C DFD 0.3 C DFD 0.5 C DFD 0.7 C DFD 1.0 C DFD 1.5 C DFD 2.5
10A male contacts 0.14÷0.37 mm ² AWG 26÷22 identification No. 1 0.5 mm ² AWG 20 identification No. 2 0.75 mm ² AWG 18 identification No. ② 1 mm ² AWG 18 identification No. 3 1.5 mm ² AWG 16 identification No. 4 2.5 mm ² AWG 14 identification No. 5			silver plated C D M A 0.3 C D M A 0.5 C D M A 0.7 C D M A 1.0 C D M A 1.5 C D M A 2.5	gold plated C D M D 0.3 C D M D 0.5 C D M D 0.7 C D M D 1.0 C D M D 1.5 C D M D 2.5

¹⁾ the female inserts can be mounted into the straight bulkhead housings CK I from the rear

dimensions in mm

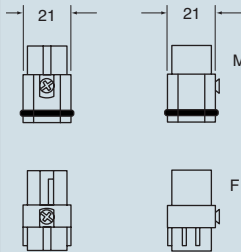

contacts side (front view)



dimensions in mm

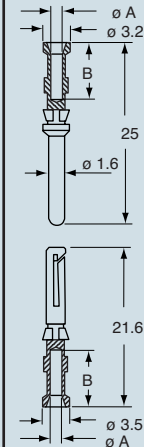

N.B.:
 plug inserts with new, square shaped seal for IP44 and IP66/IP67 protection rating (see "21.21" size enclosures section from page 153)

CDF and CDM contacts

conductor section mm ²	conductor slot ø A (mm)	B (mm)
0.14÷0.37	0.9	8
0.5	1.1	8
0.75	1.3	8
1.0	1.45	8
1.5	1.8	8
2.5	2.2	6

- stripping length see section feature of inserts on page 13

dimensions indicated are not binding and may be changed without notice

enclosures size "21.21"

insulating type page: 153 ÷ 154
 metallic type page: 155 ÷ 156
 aggressive environments page: 157
 EMC page: 158

- features according to EN 61984:
10A 50V 0,8kV 3
- UL, CSA, CCC, GL certified
- for maximum current load, see the insert load curve section on page 29
- for contact crimping instructions, please see the crimping tool section (10A contacts, CDF and CDM series) on pages 296, 300, 304, 306, 308
- coding pin with loss of a contact CR CP

inserts, crimp connections

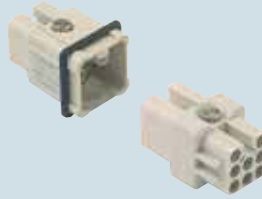

10A crimp contacts silver and gold plated



description	part No.	part No.	part No.
-------------	----------	----------	----------

without contacts (to be ordered separately)
 female inserts for female contacts ¹⁾
 male inserts for male contacts

CDF 08
CDM 08

10A female contacts

0.14÷0.37 mm ²	AWG 26÷22	identification No. 1
0.5 mm ²	AWG 20	identification No. 2
0.75 mm ²	AWG 18	identification No. ②
1 mm ²	AWG 18	identification No. 3
1.5 mm ²	AWG 16	identification No. 4
2.5 mm ²	AWG 14	identification No. 5

CDF	silver plated	CD	gold plated
CDFA 0.3		CDFD 0.3	
CDFA 0.5		CDFD 0.5	
CDFA 0.7		CDFD 0.7	
CDFA 1.0		CDFD 1.0	
CDFA 1.5		CDFD 1.5	
CDFA 2.5		CDFD 2.5	

10A male contacts

0.14÷0.37 mm ²	AWG 26÷22	identification No. 1
0.5 mm ²	AWG 20	identification No. 2
0.75 mm ²	AWG 18	identification No. ②
1 mm ²	AWG 18	identification No. 3
1.5 mm ²	AWG 16	identification No. 4
2.5 mm ²	AWG 14	identification No. 5

CDM	silver plated	CD	gold plated
CDMA 0.3		CDMD 0.3	
CDMA 0.5		CDMD 0.5	
CDMA 0.7		CDMD 0.7	
CDMA 1.0		CDMD 1.0	
CDMA 1.5		CDMD 1.5	
CDMA 2.5		CDMD 2.5	

¹⁾ the female inserts can be mounted into the straight bulkhead housings CK I from the rear

dimensions in mm

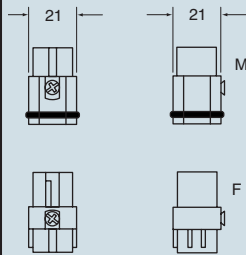

dimensions in mm

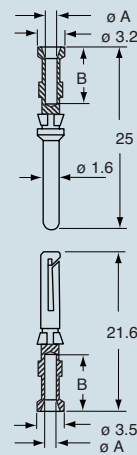

N.B.:
 plug inserts with new, square shaped seal for IP44 and IP66/IP67 protection rating (see "21.21" size enclosures section from page 153)

contacts side (front view)

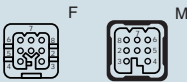

CDF and CDM contacts

conductor section mm ²	conductor slot	
	ø A (mm)	B (mm)
0.14÷0.37	0.9	8
0.5	1.1	8
0.75	1.3	8
1.0	1.45	8
1.5	1.8	8
2.5	2.2	6

- stripping length see section feature of inserts on page 13

dimensions indicated are not binding and may be changed without notice

CD

enclosures **size "49.16"**

standard page: 162 ÷ 163
aggressive environments page: 164
EMC page: 165

panel supports:

COB + adaptor page: 258 ÷ 260

- features according to EN 61984:

- 10A 250V 4kV 3**
- compliant with DIN EC 175-301-801 standard
- UL, CSA, CCC, GL certified
- for maximum current load, see the insert load curve section on page 29
- for applications requiring higher voltages, please see the special voltage application section on page 38
- for contact crimping instructions, please see the crimping tool section (10A contacts, CDF and CDM series) on pages 296, 300, 304, 306, 308

inserts, crimp connections

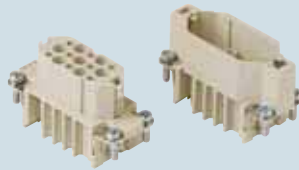

10A crimp contacts silver and gold plated



description

part No.

part No. part No.

without contacts (to be ordered separately)
 female inserts for female contacts
 male inserts for male contacts

CDF 15
CDM 15

10A female contacts

0.14÷0.37 mm ²	AWG 26÷22	identification No. 1
0.5 mm ²	AWG 20	identification No. 2
0.75 mm ²	AWG 18	identification No. ②
1 mm ²	AWG 18	identification No. 3
1.5 mm ²	AWG 16	identification No. 4
2.5 mm ²	AWG 14	identification No. 5

CDFA 0.3	silver plated	CDFD 0.3	gold plated
CDFA 0.5		CDFD 0.5	
CDFA 0.7		CDFD 0.7	
CDFA 1.0		CDFD 1.0	
CDFA 1.5		CDFD 1.5	
CDFA 2.5		CDFD 2.5	

10A male contacts

0.14÷0.37 mm ²	AWG 26÷22	identification No. 1
0.5 mm ²	AWG 20	identification No. 2
0.75 mm ²	AWG 18	identification No. ②
1 mm ²	AWG 18	identification No. 3
1.5 mm ²	AWG 16	identification No. 4
2.5 mm ²	AWG 14	identification No. 5

CDMA 0.3	silver plated	CDMD 0.3	gold plated
CDMA 0.5		CDMD 0.5	
CDMA 0.7		CDMD 0.7	
CDMA 1.0		CDMD 1.0	
CDMA 1.5		CDMD 1.5	
CDMA 2.5		CDMD 2.5	

dimensions in mm

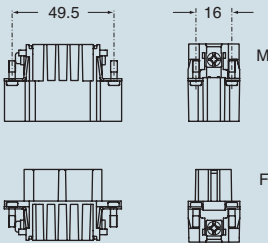

contacts side (front view)

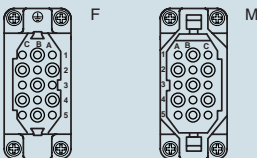

dimensions in mm

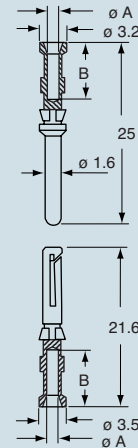

CDF and CDM contacts

conductor section mm ²	conductor slot	
	ø A (mm)	B (mm)
0.14÷0.37	0.9	8
0.5	1.1	8
0.75	1.3	8
1.0	1.45	8
1.5	1.8	8
2.5	2.2	6

- stripping length see section feature of inserts on pages 13

dimensions indicated are not binding and may be changed without notice

enclosures size "66.16"

standard page: 166 ÷ 167
 aggressive environments page: 168
 EMC page: 169
 panel supports:
 COB + adaptor page: 258 ÷ 260

- features according to EN 61984:
- 10A 250V 4kV 3**
- compliant with DIN EC 175-301-801 standard
- UL, CSA, CCC, GL certified
- for maximum current load, see the insert load curve section on page 29
- for applications requiring higher voltages, please see the special voltage application section on page 38
- for contact crimping instructions, please see the crimping tool section (10A contacts, CDF and CDM series) on pages 296, 300, 304, 306, 308

inserts, crimp connections

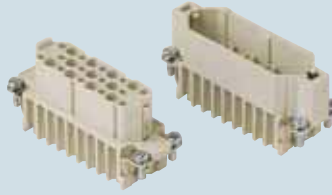

10A crimp contacts silver and gold plated



description	part No.	part No.	part No.
-------------	----------	----------	----------

without contacts (to be ordered separately)
 female inserts for female contacts
 male inserts for male contacts

CDF 25
 CDM 25

10A female contacts

0.14÷0.37 mm ²	AWG 26÷22	identification No. 1
0.5 mm ²	AWG 20	identification No. 2
0.75 mm ²	AWG 18	identification No. ②
1 mm ²	AWG 18	identification No. 3
1.5 mm ²	AWG 16	identification No. 4
2.5 mm ²	AWG 14	identification No. 5

silver plated	CDF A 0.3	CDF D 0.3
	CDF A 0.5	CDF D 0.5
	CDF A 0.7	CDF D 0.7
	CDF A 1.0	CDF D 1.0
	CDF A 1.5	CDF D 1.5
	CDF A 2.5	CDF D 2.5

gold plated

10A male contacts

0.14÷0.37 mm ²	AWG 26÷22	identification No. 1
0.5 mm ²	AWG 20	identification No. 2
0.75 mm ²	AWG 18	identification No. ②
1 mm ²	AWG 18	identification No. 3
1.5 mm ²	AWG 16	identification No. 4
2.5 mm ²	AWG 14	identification No. 5

gold plated	CDM A 0.3	CDM D 0.3
	CDM A 0.5	CDM D 0.5
	CDM A 0.7	CDM D 0.7
	CDM A 1.0	CDM D 1.0
	CDM A 1.5	CDM D 1.5
	CDM A 2.5	CDM D 2.5

dimensions in mm

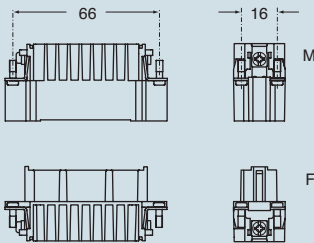

contacts side (front view)

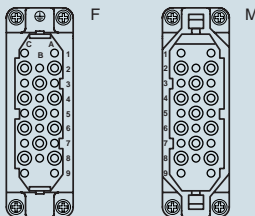

dimensions in mm

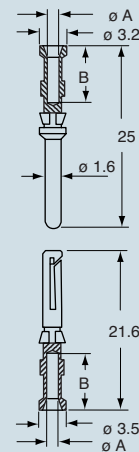

CDF and CDM contacts

conductor section mm ²	conductor slot	
	ø A (mm)	B (mm)
0.14÷0.37	0.9	8
0.5	1.1	8
0.75	1.3	8
1.0	1.45	8
1.5	1.8	8
2.5	2.2	6

- stripping length see section feature of inserts on page 13

dimensions indicated are not binding and may be changed without notice

CD

enclosures size "77.27"

standard page: 198 ÷ 202
 aggressive environments page: 209
 EMC page: 210

panel supports:

COB page: 258 ÷ 259

- features according to EN 61984:

10A 250V 4kV 3

- compliant with DIN EC 175-301-801 standard
- UL, CSA, CCC, GL certified
- for maximum current load, see the insert load curve section on page 29
- for applications requiring higher voltages, please see the special voltage application section on page 38
- for contact crimping instructions, please see the crimping tool section (10A contacts, CDF and CDM series) on pages 296, 300, 304, 306, 308

inserts, crimp connections

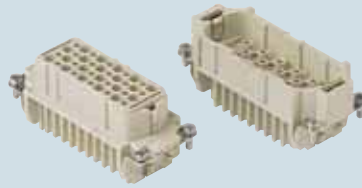

10A crimp contacts silver and gold plated



description

part No.

part No. part No.

without contacts (to be ordered separately)
 female inserts for female contacts
 male inserts for male contacts

CDF 40
 CDM 40

10A female contacts

0.14÷0.37 mm ²	AWG 26÷22	identificativo 1
0.5 mm ²	AWG 20	identificativo 2
0.75 mm ²	AWG 18	identificativo ②
1 mm ²	AWG 18	identificativo 3
1.5 mm ²	AWG 16	identificativo 4
2.5 mm ²	AWG 14	identificativo 5

10A male contacts

0.14÷0.37 mm ²	AWG 26÷22	identificativo 1
0.5 mm ²	AWG 20	identificativo 2
0.75 mm ²	AWG 18	identificativo ②
1 mm ²	AWG 18	identificativo 3
1.5 mm ²	AWG 16	identificativo 4
2.5 mm ²	AWG 14	identificativo 5

CDFA 0.3
 CDFA 0.5
 CDFA 0.7
 CDFA 1.0
 CDFA 1.5
 CDFA 2.5

silver plated

CDFD 0.3
 CDFD 0.5
 CDFD 0.7
 CDFD 1.0
 CDFD 1.5
 CDFD 2.5

gold plated

CDMA 0.3
 CDMA 0.5
 CDMA 0.7
 CDMA 1.0
 CDMA 1.5
 CDMA 2.5

CDMD 0.3
 CDMD 0.5
 CDMD 0.7
 CDMD 1.0
 CDMD 1.5
 CDMD 2.5

dimensions in mm

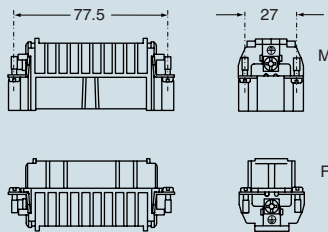

contacts side (front view)

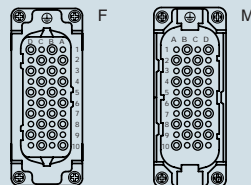

dimensions in mm

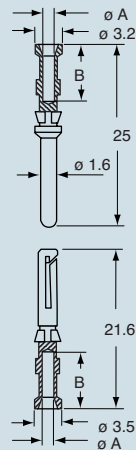

CDF and CDM contacts

conductor section mm ²	conductor slot ø A (mm)	B (mm)
0.14÷0.37	0.9	8
0.5	1.1	8
0.75	1.3	8
1.0	1.45	8
1.5	1.8	8
2.5	2.2	6

- stripping length see section feature of inserts on page 13

dimensions indicated are not binding and may be changed without notice

enclosures size "66.40"

standard page: 171 ÷ 173

aggressive environments page: 174

- features according to EN 61984:

10A 250V 4kV 3

- compliant with DIN EC 175-301-801 standard
- UL, CSA, CCC, GL certified
- for maximum current load, see the insert load curve section on page 29
- for applications requiring higher voltages, please see the special voltage application section on page 38
- for contact crimping instructions, please see the crimping tool section (10A contacts, CDF and CDM series) on pages 296, 300, 304, 306, 308

inserts, crimp connections

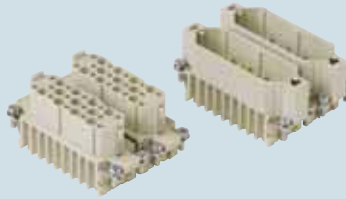

10A crimp contacts silver and gold plated



description

part No. part No.

part No. part No.

without contacts (to be ordered separately)
female inserts, No. (A1÷C9) and (ZA1÷ZC9)*
male inserts, No. (A1÷C9) and (ZA1÷ZC9)*

CDF 25 **CDM 25** **CDF 25 Z *** **CDM 25 Z ***

10A female contacts

0.14÷0.37 mm ²	AWG 26÷22	identification No. 1
0.5 mm ²	AWG 20	identification No. 2
0.75 mm ²	AWG 18	identification No. ②
1 mm ²	AWG 18	identification No. 3
1.5 mm ²	AWG 16	identification No. 4
2.5 mm ²	AWG 14	identification No. 5

CDFA 0.3	silver plated	CDFD 0.3	gold plated
CDFA 0.5		CDFD 0.5	
CDFA 0.7		CDFD 0.7	
CDFA 1.0		CDFD 1.0	
CDFA 1.5		CDFD 1.5	
CDFA 2.5		CDFD 2.5	

10A male contacts

0.14÷0.37 mm ²	AWG 26÷22	identification No. 1
0.5 mm ²	AWG 20	identification No. 2
0.75 mm ²	AWG 18	identification No. ②
1 mm ²	AWG 18	identification No. 3
1.5 mm ²	AWG 16	identification No. 4
2.5 mm ²	AWG 14	identification No. 5

CDMA 0.3	silver plated	CDMD 0.3	gold plated
CDMA 0.5		CDMD 0.5	
CDMA 0.7		CDMD 0.7	
CDMA 1.0		CDMD 1.0	
CDMA 1.5		CDMD 1.5	
CDMA 2.5		CDMD 2.5	

* coding compliant with EUROMAP recommendations

dimensions in mm

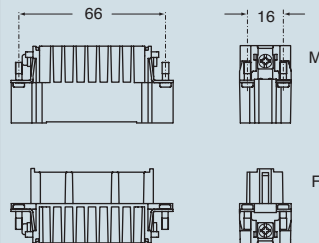

dimensions in mm

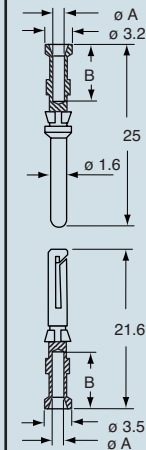

contacts side (front view)

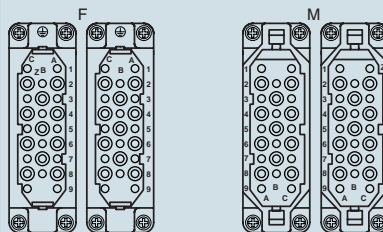

CDF and CDM contacts

conductor section mm ²	conductor slot	
	ø A (mm)	B (mm)
0.14÷0.37	0.9	8
0.5	1.1	8
0.75	1.3	8
1.0	1.45	8
1.5	1.8	8
2.5	2.2	6

- stripping length see section feature of inserts on page 13

dimensions indicated are not binding and may be changed without notice

CD

enclosures size "104.27"

standard page: 212 ÷ 216
 aggressive environments page: 223
 EMC page: 224

panel supports:

COB page: 258 ÷ 259

- features according to EN 61984:

10A 250V 4kV 3

- compliant with DIN EC 175-301-801 standard
- UL, CSA, CCC, GL certified
- for maximum current load, see the insert load curve section on page 29
- for applications requiring higher voltages, please see the special voltage application section on page 38
- for contact crimping instructions, please see the crimping tool section (10A contacts, CDF and CDM series) on pages 296, 300, 304, 306, 308

inserts, crimp connections

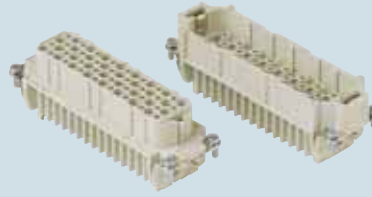

10A crimp contacts silver and gold plated



description

part No.

part No. part No.

without contacts (to be ordered separately)
 female inserts for female contacts
 male inserts for male contacts

CDF 64
 CDM 64

10A female contacts

0.14÷0.37 mm ²	AWG 26÷22	identification No. 1
0.5 mm ²	AWG 20	identification No. 2
0.75 mm ²	AWG 18	identification No. ②
1 mm ²	AWG 18	identification No. 3
1.5 mm ²	AWG 16	identification No. 4
2.5 mm ²	AWG 14	identification No. 5

10A male contacts

0.14÷0.37 mm ²	AWG 26÷22	identification No. 1
0.5 mm ²	AWG 20	identification No. 2
0.75 mm ²	AWG 18	identification No. ②
1 mm ²	AWG 18	identification No. 3
1.5 mm ²	AWG 16	identification No. 4
2.5 mm ²	AWG 14	identification No. 5

CDF A 0.3
 CDF A 0.5
 CDF A 0.7
 CDF A 1.0
 CDF A 1.5
 CDF A 2.5

silver plated

CDF D 0.3
 CDF D 0.5
 CDF D 0.7
 CDF D 1.0
 CDF D 1.5
 CDF D 2.5

gold plated

CDM A 0.3
 CDM A 0.5
 CDM A 0.7
 CDM A 1.0
 CDM A 1.5
 CDM A 2.5

CDM D 0.3
 CDM D 0.5
 CDM D 0.7
 CDM D 1.0
 CDM D 1.5
 CDM D 2.5

dimensions in mm

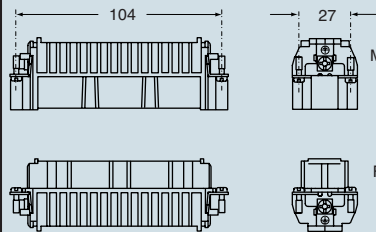

contacts side (front view)

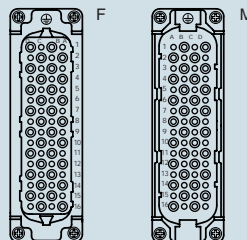

dimensions in mm

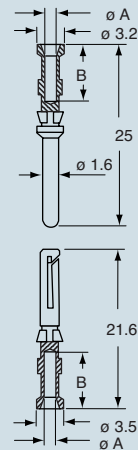

CDF and CDM contacts

conductor section mm ²	conductor slot ø A (mm)	B (mm)
0.14÷0.37	0.9	8
0.5	1.1	8
0.75	1.3	8
1.0	1.45	8
1.5	1.8	8
2.5	2.2	6

- stripping length see section feature of inserts on page 13

dimensions indicated are not binding and may be changed without notice

enclosures: size "77.62"

standard page: 226 ÷ 229

aggressive environments page: 230

- features according to EN 61984:
- 10A 250V 4kV 3**
- compliant with DIN EC 175-301-801 standard
- UL, CSA, CCC, GL certified
- for maximum current load, see the insert load curve section on page 29
- for applications requiring higher voltages, please see the special voltage application section on page 38
- for contact crimping instructions, please see the crimping tool section (10A contacts, CDF and CDM series) on pages 296, 300, 304, 306, 308

inserts, crimp connections

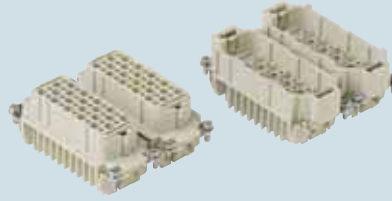

10A crimp contacts silver and gold plated



description	part No.	part No.	part No.	part No.
without contacts (to be ordered separately)				
female inserts	CDF 40	CDF 40		
male inserts	CDM 40	CDM 40		
10A female contacts				
0.14÷0.37 mm ² AWG 26÷22 identification No. 1			CDFA 0.3	CDFD 0.3
0.5 mm ² AWG 20 identification No. 2			CDFA 0.5	CDFD 0.5
0.75 mm ² AWG 18 identification No. ②			CDFA 0.7	CDFD 0.7
1 mm ² AWG 18 identification No. 3			CDFA 1.0	CDFD 1.0
1.5 mm ² AWG 16 identification No. 4			CDFA 1.5	CDFD 1.5
2.5 mm ² AWG 14 identification No. 5			CDFA 2.5	CDFD 2.5
10A male contacts				
0.14÷0.37 mm ² AWG 26÷22 identification No. 1			CDMA 0.3	CDMD 0.3
0.5 mm ² AWG 20 identification No. 2			CDMA 0.5	CDMD 0.5
0.75 mm ² AWG 18 identification No. ②			CDMA 0.7	CDMD 0.7
1 mm ² AWG 18 identification No. 3			CDMA 1.0	CDMD 1.0
1.5 mm ² AWG 16 identification No. 4			CDMA 1.5	CDMD 1.5
2.5 mm ² AWG 14 identification No. 5			CDMA 2.5	CDMD 2.5

silver plated

gold plated

dimensions in mm

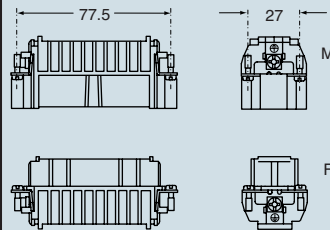

contacts side (front view)

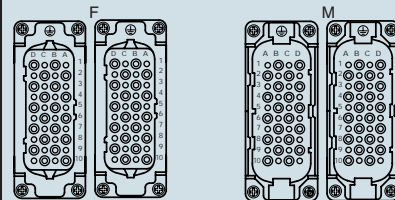

dimensions in mm

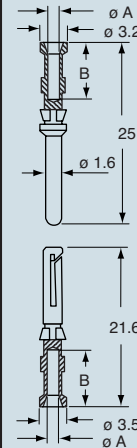

CDF and CDM contacts

conductor section mm ²	conductor slot	
	ø A (mm)	B (mm)
0.14÷0.37	0.9	8
0.5	1.1	8
0.75	1.3	8
1.0	1.45	8
1.5	1.8	8
2.5	2.2	6

- stripping length see section feature of inserts on page 13

dimensions indicated are not binding and may be changed without notice

enclosures: size "104.62"
 standard page: 232
 aggressive environments page: 234

- features according to EN 61984: **10A 250V 4kV 3**
- compliant with DIN EC 175-301-801 standard
- UL, CSA, CCC, GL certified
- for maximum current load, see the insert load curve section on page 29
- for applications requiring higher voltages, please see the special voltage application section on page 38
- for contact crimping instructions, please see the crimping tool section (10A contacts, CDF and CDM series) on pages 296, 300, 304, 306, 308

inserts, crimp connections

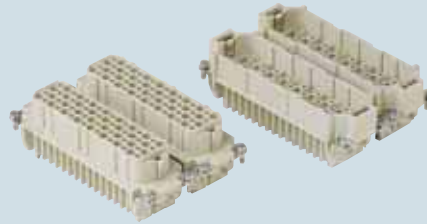

10A crimp contacts silver and gold plated



description	part No.	part No.	part No.	part No.
without contacts (to be ordered separately) female inserts male inserts	CDF 64 CDM 64	CDF 64 CDM 64		
10A female contacts 0.14÷0.37 mm ² AWG 26÷22 identification No. 1 0.5 mm ² AWG 20 identification No. 2 0.75 mm ² AWG 18 identification No. ② 1 mm ² AWG 18 identification No. 3 1.5 mm ² AWG 16 identification No. 4 2.5 mm ² AWG 14 identification No. 5			CDFA 0.3 CDFA 0.5 CDFA 0.7 CDFA 1.0 CDFA 1.5 CDFA 2.5	CDFD 0.3 CDFD 0.5 CDFD 0.7 CDFD 1.0 CDFD 1.5 CDFD 2.5
10A male contacts 0.14÷0.37 mm ² AWG 26÷22 identification No. 1 0.5 mm ² AWG 20 identification No. 2 0.75 mm ² AWG 18 identification No. ② 1 mm ² AWG 18 identification No. 3 1.5 mm ² AWG 16 identification No. 4 2.5 mm ² AWG 14 identification No. 5			CDMA 0.3 CDMA 0.5 CDMA 0.7 CDMA 1.0 CDMA 1.5 CDMA 2.5	CDMD 0.3 CDMD 0.5 CDMD 0.7 CDMD 1.0 CDMD 1.5 CDMD 2.5

dimensions in mm

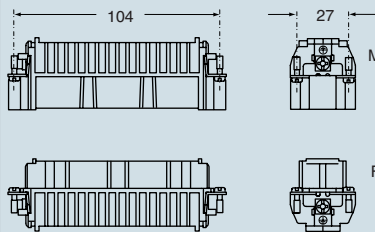

contacts side (front view)

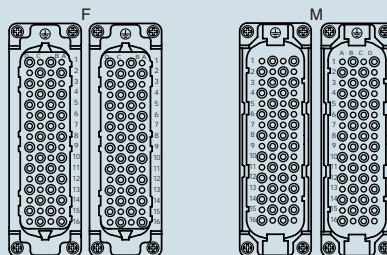

dimensions in mm

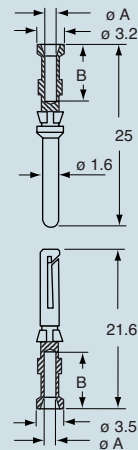

CDF and CDM contacts

conductor section mm ²	conductor slot ø A (mm)	B (mm)
0.14÷0.37	0.9	8
0.5	1.1	8
0.75	1.3	8
1.0	1.45	8
1.5	1.8	8
2.5	2.2	6

- stripping length see section feature of inserts on page 13

dimensions indicated are not binding and may be changed without notice

Use

The CT-series multipole connectors (with incorporated terminal block) are recommended for greater cost-saving and safety for use on machines and command and control panels.

For control panel mounting, bulkhead housings must be used. This makes it possible to maintain the IP65 degree of protection (in accordance with EN 60529) for coupled housing-mounted connectors.

The CT series inserts (10A max versions) are supplied in the plug or socket versions and must be mounted with insertion from the rear of the enclosure (Figures 1 and 2). The space occupied by the terminal block does not allow for the passage of the insert and insertion from the front of the enclosure.

As an alternative to the traditional terminal blocks, the inserts can be mounted inside the control panels on DIN EN rails (Figure 5) using suitable accessories providing the added advantage of easy sectioning.

The special structure of the CT inserts has all the conductor connections on the same side providing for easier wiring and a complete view of the work area.

The terminal block also has slots for housing the identification wire markers of each contact. Wire markers of different manufacturers may be used such as: Cabur, Grafoplast, Modernotecnica, Phoenix, Siemens, Wago, Weidmüller.

The CT series is available in the versions "left" and "right" for mounting on the left (Figure 3) or on the right (Figure 4) of the control panel walls.

This characteristic is determined by the position of contact "1" and the ground terminal in the upper part of the insert terminal block for both left and right mounting.

The installation of inserts on DIN rails (Figure 5) inside the control panels is usually made to facilitate the wiring in sectionable parts.

In this case the degree of protection for coupled connectors is IP20 (in accordance with EN 60529).

This type of mounting requires supports (CT APE) to be provided to the inserts suitable for mounting on DIN EN 60715 rail.

In addition, CRBF (female) and CRBM (male) coupling screws instead of normal screws are recommended for fixing the inserts to the enclosures (Figure 5) in order to guarantee a stable and safe coupling between the CT and CTS inserts installed on the DIN rails and corresponding CD inserts.

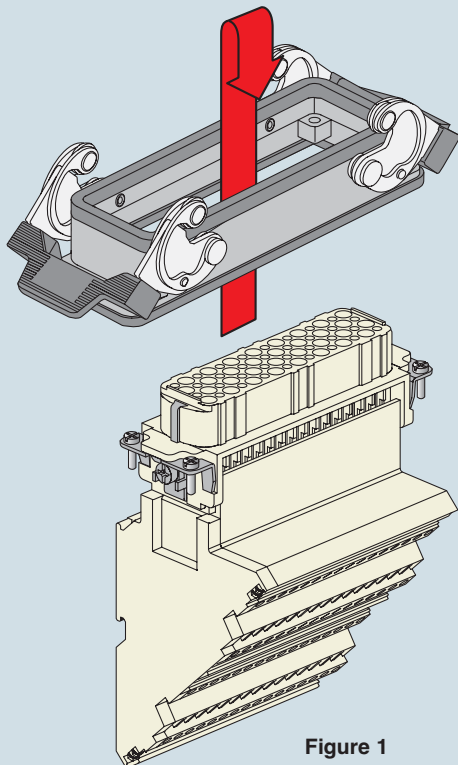

Figure 1

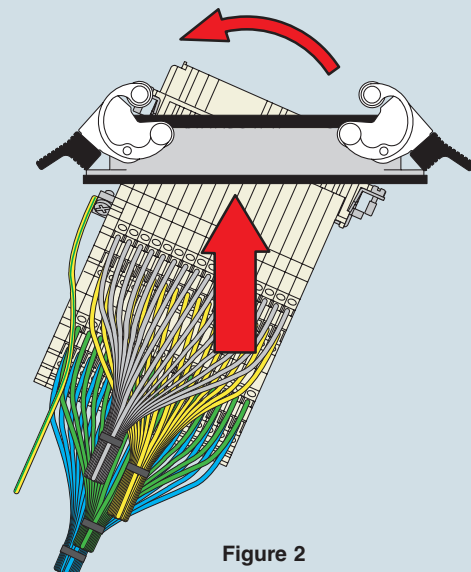

Figure 2

Figures 1 and 2 (rear mounting)

The insert is inserted into the bulkhead housing with pre-wired conductors connected at the opposite end.

Figure 3 (left mounting)

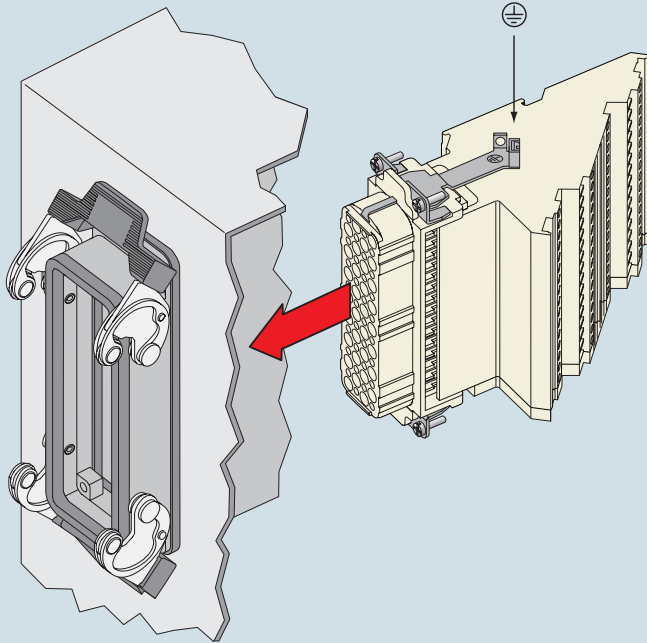
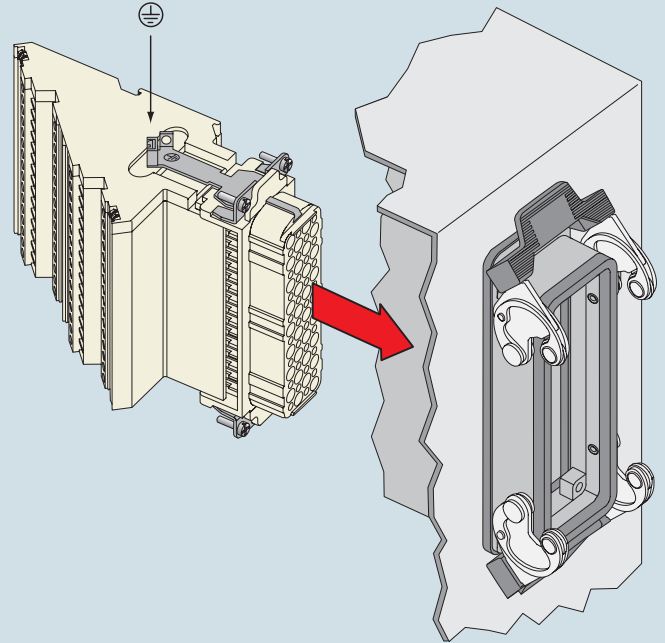
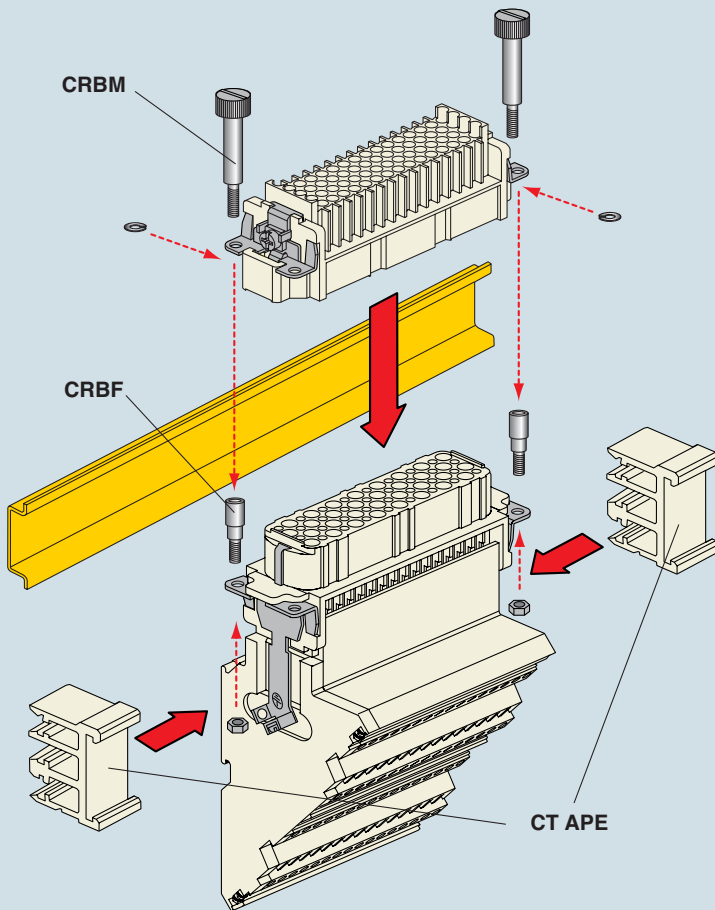

Figure 4 (right mounting)



CT - CTS

Figure 5 (mounting on DIN rail)



CT APE

possibility of coupling to DIN EN 60715 rail (for a greater stability of the CT inserts of 40 and 64 poles we recommend using the two CT APE supports)

**EN 60715
C 30**

**EN 60715
G 32**

**EN 60715
TH 35-7.5 and TH 35-15**

accessories for CT inserts

- support for mounting on DIN rail (**CT APE** page 263)
- inserts coupling screws (**CRBM** and **CRBF** page 263)
- cable-clamping plates (**CRAD** and **CRAS** page 263)

enclosures¹⁾:

size "77.27"

standard page: 198
aggressive environments page: 209
EMC page: 210

¹⁾ only bulkhead mounted housings

- features according to EN 61984:
10A 250V 4kV 3
- UL, CSA, CCC, GL certified
- can be mated with CD inserts
- rear-mounted inserts
- for maximum current load, see the insert load curve section on page 29

**terminal block inserts
screw terminal connection**



**terminal block inserts
spring terminal connection**



description	part No.	part No.	part No.	part No.
side-mounting female inserts with female contacts 1) male inserts with male contacts 1)	left CTF 40 L CTM 40 L	right CTF 40 R CTM 40 R		
side-mounting female inserts with female contacts male inserts with male contacts			left CTSF 40 L CTSM 40 L	right CTSF 40 R CTSM 40 R

1) for non-prepared conductors

connection with spring terminal

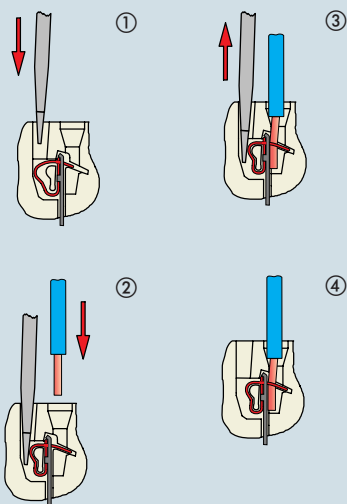

dimensions in mm

female inserts (CTF and CTSF)

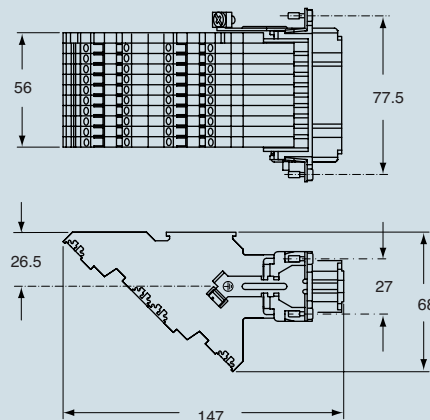

male inserts (CTM and CTSM)

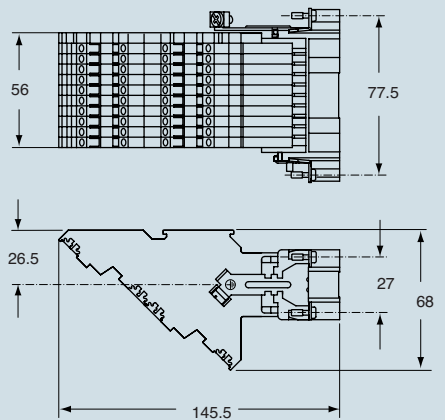

contacts side (front view)

female inserts (CTF and CTSF)

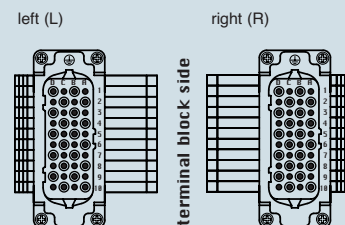

male inserts (CTM and CTSM)

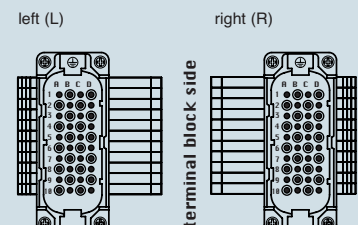

- CT inserts with plate, for section conductors:
 $0.75 \div 2.5 \text{ mm}^2$ - AWG 18 ÷ 14
- torsion couple recommended for conductor fastening screws and stripping length see section feature of inserts on page 13

- CTS spring inserts for section conductors:
 effective sections for non-prepared conductors
 $0.14 \div 2.5 \text{ mm}^2$ - AWG 26 ÷ 14
 effective sections for prepared conductors
 $0.14 \div 1 \text{ mm}^2$ - AWG 26 ÷ 18
- stripping length see section feature of inserts on page 13

dimensions indicated are not binding and may be changed without notice

CT - CTS

enclosures¹⁾:

size "104.27"

standard	page:	212
aggressive environments	page:	223
EMC	page:	224

¹⁾ only bulkhead mounted housings

- features according to EN 61984:
- 10A 250V 4kV 3**
- UL, CSA, CCC, GL certified
- can be mated with CD inserts
- rear-mounted inserts
- for maximum current load, see the insert load curve section on page 29

**terminal block inserts
screw terminal connection**

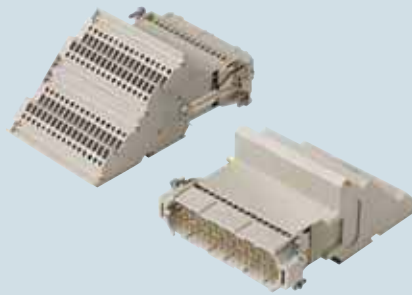

**terminal block inserts
spring terminal connection**



description	part No.	part No.	part No.	part No.
side-mounting female inserts with female contacts 1) male inserts with male contacts 1)	left CTF 64 L CTM 64 L	right CTF 64 R CTM 64 R	left CTS F 64 L CTSM 64 L	right CTS F 64 R CTSM 64 R
side-mounting female inserts with female contacts male inserts with male contacts				

1) for non-prepared conductors

connection with spring terminal

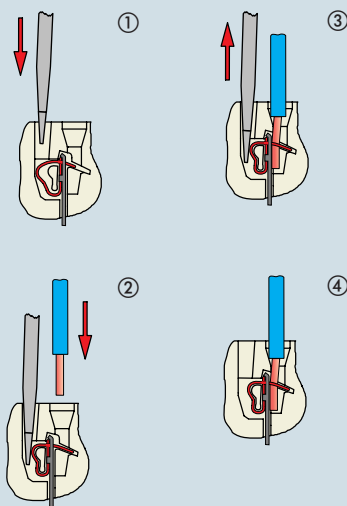

dimensions in mm

female inserts (CTF and CTSF)

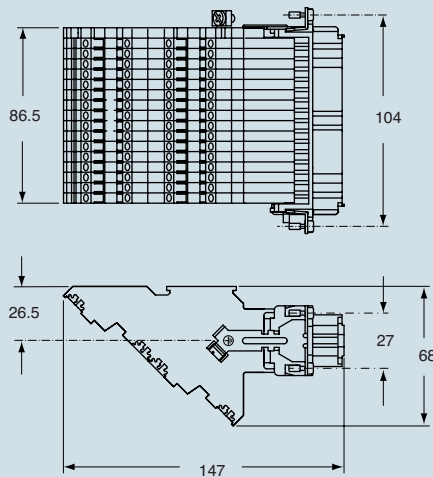

male inserts (CTM and CTSM)

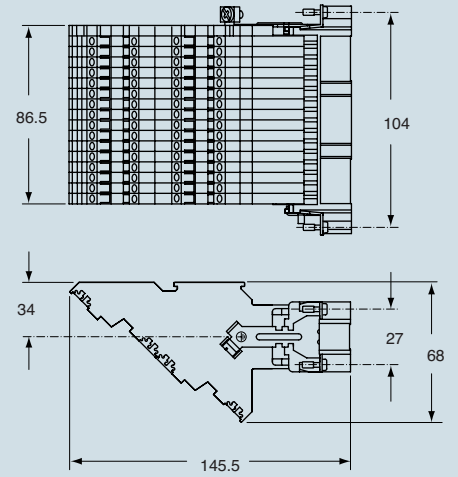

contacts side (front view)

female inserts (CTF and CTSF)

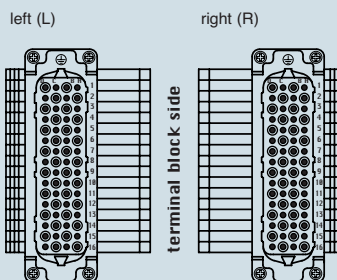

male inserts (CTM and CTSM)

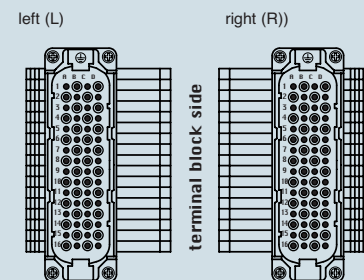

- CT inserts with plate, for section conductors:
0.75 ÷ 2.5 mm² - AWG 18 ÷ 14
- torsion couple recommended for conductor fastening screws and stripping length see section feature of inserts on page 13

- CTS spring inserts for section conductors:
effective sections for non-prepared conductors
0.14 ÷ 2.5 mm² - AWG 26 ÷ 14
effective sections for prepared conductors
0.14 ÷ 1 mm² - AWG 26 ÷ 18
- stripping length see section feature of inserts on page 13

dimensions indicated are not binding and may be changed without notice

When all the contacts are used, the CDD inserts series connectors may be used with voltages of up to 250V (first column); pollution rate 2, in accordance with the standard EN 61984.
 If the number of contacts is reduced and the contacts accordingly assigned, these connectors may be used with higher voltages. This is possible because the decrease in the number of contacts leads to an increase in the surface insulation distance in the air. When the contacts are arranged as shown below, the inserts may be used for voltages of 400V (second column) and 500V (third column); pollution rate 2, in accordance with the standard EN 61984.

Legend:

- working contact
- without contact
- M = male insert
- F = female insert

for use up to 250V
pollution rate 2

diagrams
contacts side (front view)

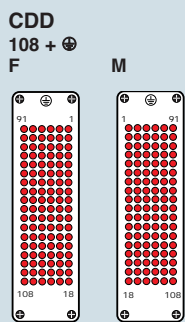
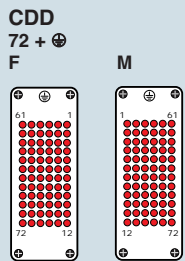
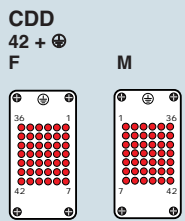
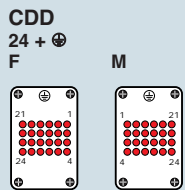

for use up to 400V
pollution rate 2

diagrams
contacts side (front view)

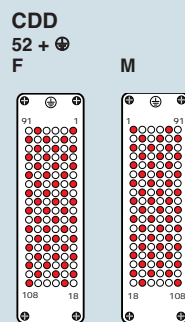
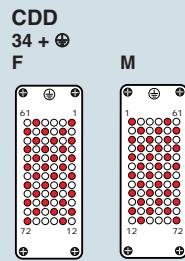
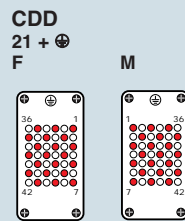
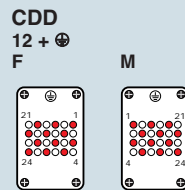

for use up to 500V
pollution rate 2

diagrams
contacts side (front view)

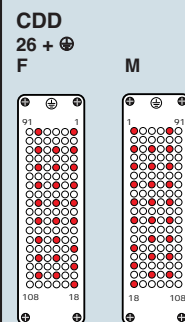
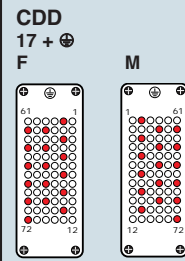
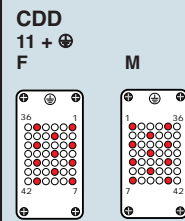
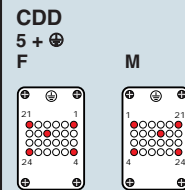

CDD

enclosures: **size "44.27"**

standard page: 176 ÷ 179
aggressive environments page: 181
EMC page: 182

panel supports:
COB page: 258 ÷ 259

- features according to EN 61984:
- 10A 250V 4kV 2**
- UL, CSA, CCC, GL certified
- for maximum current load, see the insert load curve section on page 29
- for applications with higher voltages, see the special voltage application section on page 52
- for contact crimping instructions, please see the crimping tool section (10A contacts, CDF and CDM series) on pages 296, 300, 304, 306, 308
- PCBs interface, see article CIF 2.4

inserts, crimp connections



10A crimp contacts silver and gold plated



description	part No.	part No.	part No.
without contacts (to be ordered separately)			
female inserts for female contacts	CDDF 24		
male inserts for male contacts	CDDM 24		
10A female contacts			
0.14÷0.37 mm ² AWG 26÷22 identification No. 1		CDFA 0.3	CDFD 0.3
0.5 mm ² AWG 20 identification No. 2		CDFA 0.5	CDFD 0.5
0.75 mm ² AWG 18 identification No. ②		CDFA 0.7	CDFD 0.7
1 mm ² AWG 18 identification No. 3		CDFA 1.0	CDFD 1.0
1.5 mm ² AWG 16 identification No. 4		CDFA 1.5	CDFD 1.5
2.5 mm ² AWG 14 identification No. 5		CDFA 2.5	CDFD 2.5
10A male contacts			
0.14÷0.37 mm ² AWG 26÷22 identification No. 1		CDMA 0.3	CDMD 0.3
0.5 mm ² AWG 20 identification No. 2		CDMA 0.5	CDMD 0.5
0.75 mm ² AWG 18 identification No. ②		CDMA 0.7	CDMD 0.7
1 mm ² AWG 18 identification No. 3		CDMA 1.0	CDMD 1.0
1.5 mm ² AWG 16 identification No. 4		CDMA 1.5	CDMD 1.5
2.5 mm ² AWG 14 identification No. 5		CDMA 2.5	CDMD 2.5

dimensions in mm

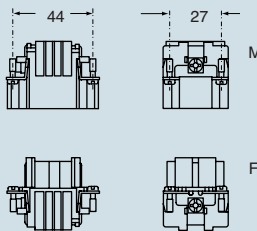

contacts side (front view)

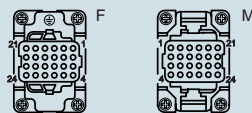

dimensions in mm

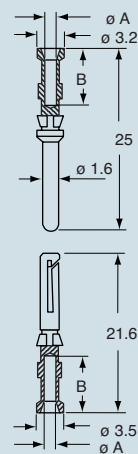

CDF and CDM contacts

conductor section mm ²	conductor slot ø A (mm)	B (mm)
0.14÷0.37	0.9	8
0.5	1.1	8
0.75	1.3	8
1.0	1.45	8
1.5	1.8	8
2.5	2.2	6

- stripping length see section feature of inserts on page 13

dimensions indicated are not binding and may be changed without notice

enclosures: **size "66.16"**

standard page: 166 ÷ 167
aggressive environments page: 168
EMC page: 169

panel supports:
COB + adaptor page: 258 ÷ 260

- features according to EN 61984:
10A 250V 4kV 2
- UL, CSA, CCC, GL certified
- for maximum current load, see the insert load curve section on page 29
- for contact crimping instructions, please see the crimping tool section (10A contacts, CDF and CDM series) on pages 296, 300, 304, 306, 308

inserts, crimp connections

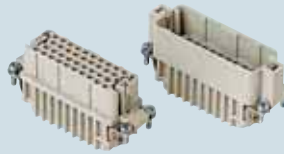

10A crimp contacts silver and gold plated



description	part No.	part No.	part No.
without contacts (to be ordered separately) female inserts for female contacts male inserts for male contacts	CDDF 38 CDDM 38		
10A female contacts			
0.14÷0.37 mm ² AWG 26÷22 identification No. 1		CDFA 0.3	CDFD 0.3
0.5 mm ² AWG 20 identification No. 2		CDFA 0.5	CDFD 0.5
0.75 mm ² AWG 18 identification No. ②		CDFA 0.7	CDFD 0.7
1 mm ² AWG 18 identification No. 3		CDFA 1.0	CDFD 1.0
1.5 mm ² AWG 16 identification No. 4		CDFA 1.5	CDFD 1.5
2.5 mm ² AWG 14 identification No. 5		CDFA 2.5	CDFD 2.5
10A male contacts			
0.14÷0.37 mm ² AWG 26÷22 identification No. 1		CDMA 0.3	CDMD 0.3
0.5 mm ² AWG 20 identification No. 2		CDMA 0.5	CDMD 0.5
0.75 mm ² AWG 18 identification No. ②		CDMA 0.7	CDMD 0.7
1 mm ² AWG 18 identification No. 3		CDMA 1.0	CDMD 1.0
1.5 mm ² AWG 16 identification No. 4		CDMA 1.5	CDMD 1.5
2.5 mm ² AWG 14 identification No. 5		CDMA 2.5	CDMD 2.5

silver plated

gold plated

dimensions in mm

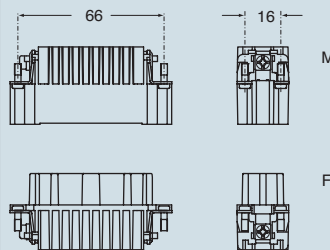

contacts side (front view)

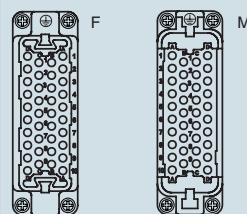

dimensions in mm

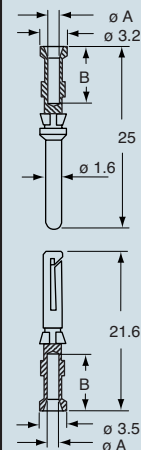

CDF and CDM contacts

conductor section mm ²	conductor slot ø A (mm)	B (mm)
0.14÷0.37	0.9	8
0.5	1.1	8
0.75	1.3	8
1.0	1.45	8
1.5	1.8	8
2.5	2.2	6

- stripping length see section feature of inserts on page 13

dimensions indicated are not binding and may be changed without notice

enclosures: **size "57.27"**

standard page: 184 ÷ 188
aggressive environments page: 195
EMC page: 196

panel supports:
COB page: 258 ÷ 259

- features according to EN 61984:
- 10A 250V 4kV 2**
- UL, CSA, CCC, GL certified
- for maximum current load, see the insert load curve section on page 29
- for applications with higher voltages, see the special voltage application section on page 52
- for contact crimping instructions, please see the crimping tool section (10A contacts, CDF and CDM series) on pages 296, 300, 304, 306, 308
- PCBs interface, see article CIF 2.4

inserts, crimp connections

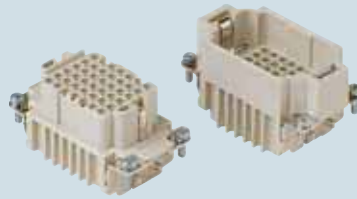

10A crimp contacts silver and gold plated



description	part No.	part No.	part No.
without contacts (to be ordered separately) female inserts for female contacts male inserts for male contacts	CDDF 42 CDDM 42		
10A female contacts 0.14÷0.37 mm ² AWG 26÷22 identification No. 1 0.5 mm ² AWG 20 identification No. 2 0.75 mm ² AWG 18 identification No. ② 1 mm ² AWG 18 identification No. 3 1.5 mm ² AWG 16 identification No. 4 2.5 mm ² AWG 14 identification No. 5		CDFA 0.3 CDFA 0.5 CDFA 0.7 CDFA 1.0 CDFA 1.5 CDFA 2.5	CDFD 0.3 CDFD 0.5 CDFD 0.7 CDFD 1.0 CDFD 1.5 CDFD 2.5
10A male contacts 0.14÷0.37 mm ² AWG 26÷22 identification No. 1 0.5 mm ² AWG 20 identification No. 2 0.75 mm ² AWG 18 identification No. ② 1 mm ² AWG 18 identification No. 3 1.5 mm ² AWG 16 identification No. 4 2.5 mm ² AWG 14 identification No. 5		CDMA 0.3 CDMA 0.5 CDMA 0.7 CDMA 1.0 CDMA 1.5 CDMA 2.5	CDMD 0.3 CDMD 0.5 CDMD 0.7 CDMD 1.0 CDMD 1.5 CDMD 2.5

dimensions in mm

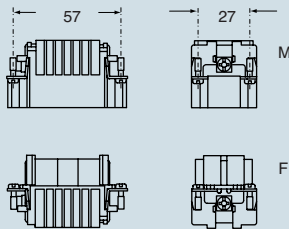

contacts side (front view)

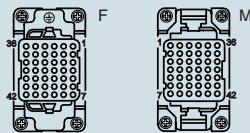

dimensions in mm

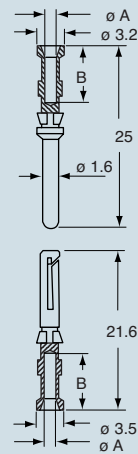

CDF and CDM contacts		
conductor section mm ²	conductor slot ø A (mm)	B (mm)
0.14÷0.37	0.9	8
0.5	1.1	8
0.75	1.3	8
1.0	1.45	8
1.5	1.8	8
2.5	2.2	6

- stripping length see section feature of inserts on page 13

dimensions indicated are not binding and may be changed without notice

enclosures: **size "77.27"**

standard page: 198 ÷ 202
aggressive environments page: 209
EMCpage: 210

panel supports:
COB page: 258 ÷ 259

- features according to EN 61984:
- 10A 250V 4kV 2**
- UL, CSA, CCC, GL certified
- for maximum current load, see the insert load curve section on page 29
- for applications with higher voltages, see the special voltage application section on page 52
- for contact crimping instructions, please see the crimping tool section (10A contacts, CDF and CDM series) pages on 296, 300, 304, 306, 308
- PCBs interface, see article CIF 2.4

inserts, crimp connections

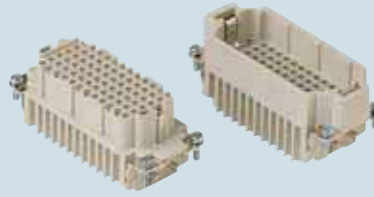

10A crimp contacts silver and gold plated



description

part No.

part No. part No.

without contacts (to be ordered separately)
 female inserts for female contacts
 male inserts for male contacts

CDDF 72
CDDM 72

10A female contacts		
0.14÷0.37 mm ²	AWG 26÷22	identification No. 1
0.5 mm ²	AWG 20	identification No. 2
0.75 mm ²	AWG 18	identification No. ②
1 mm ²	AWG 18	identification No. 3
1.5 mm ²	AWG 16	identification No. 4
2.5 mm ²	AWG 14	identification No. 5
10A male contacts		
0.14÷0.37 mm ²	AWG 26÷22	identification No. 1
0.5 mm ²	AWG 20	identification No. 2
0.75 mm ²	AWG 18	identification No. ②
1 mm ²	AWG 18	identification No. 3
1.5 mm ²	AWG 16	identification No. 4
2.5 mm ²	AWG 14	identification No. 5

silver plated		gold plated	
CDFA 0.3	CDFD 0.3		
CDFA 0.5	CDFD 0.5		
CDFA 0.7	CDFD 0.7		
CDFA 1.0	CDFD 1.0		
CDFA 1.5	CDFD 1.5		
CDFA 2.5	CDFD 2.5		
CDMA 0.3	CDMD 0.3		
CDMA 0.5	CDMD 0.5		
CDMA 0.7	CDMD 0.7		
CDMA 1.0	CDMD 1.0		
CDMA 1.5	CDMD 1.5		
CDMA 2.5	CDMD 2.5		

dimensions in mm

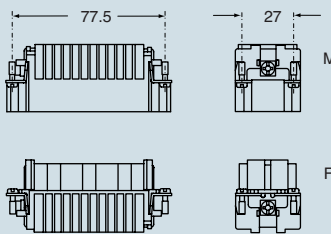

contacts side (front view)

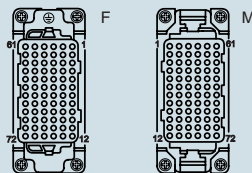

dimensions in mm

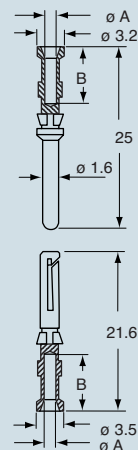

CDF and CDM contacts

conductor section mm ²	conductor slot ø A (mm)	B (mm)
0.14÷0.37	0.9	8
0.5	1.1	8
0.75	1.3	8
1.0	1.45	8
1.5	1.8	8
2.5	2.2	6

- stripping length see section feature of inserts on page 13

dimensions indicated are not binding and may be changed without notice

CDD

enclosures: size "66.40"

standard page: 171 ÷ 173

aggressive environments page: 174

- features according to EN 61984: **10A 250V 4kV 2**
- UL, CSA, CCC, GL certified
- for maximum current load, see the insert load curve section on page 29
- for contact crimping instructions, please see the crimping tool section (10A contacts, CDF and CDM series) on pages 296, 300, 304, 306, 308

inserts, crimp connections

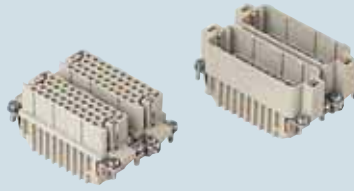

10A crimp contacts silver and gold plated



description	part No.	part No.	part No.	part No.
without contacts (to be ordered separately)				
female inserts	CDDF 38	CDDF 38		
male inserts	CDDM 38	CDDM 38		
10A female contacts				
0.14÷0.37 mm ² AWG 26÷22 identification No. 1			CDFA 0.3	CDFD 0.3
0.5 mm ² AWG 20 identification No. 2			CDFA 0.5	CDFD 0.5
0.75 mm ² AWG 18 identification No. ②			CDFA 0.7	CDFD 0.7
1 mm ² AWG 18 identification No. 3			CDFA 1.0	CDFD 1.0
1.5 mm ² AWG 16 identification No. 4			CDFA 1.5	CDFD 1.5
2.5 mm ² AWG 14 identification No. 5			CDFA 2.5	CDFD 2.5
10A male contacts				
0.14÷0.37 mm ² AWG 26÷22 identification No. 1			CDMA 0.3	CDMD 0.3
0.5 mm ² AWG 20 identification No. 2			CDMA 0.5	CDMD 0.5
0.75 mm ² AWG 18 identification No. ②			CDMA 0.7	CDMD 0.7
1 mm ² AWG 18 identification No. 3			CDMA 1.0	CDMD 1.0
1.5 mm ² AWG 16 identification No. 4			CDMA 1.5	CDMD 1.5
2.5 mm ² AWG 14 identification No. 5			CDMA 2.5	CDMD 2.5

silver plated

gold plated

dimensions in mm

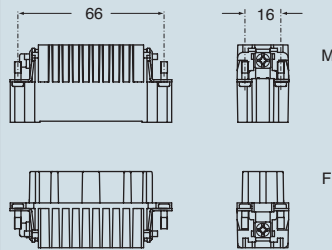

contacts side (front view)

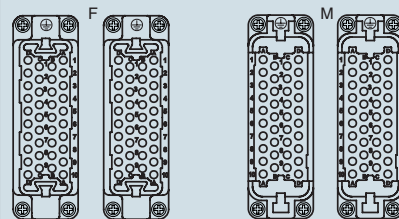

dimensions in mm

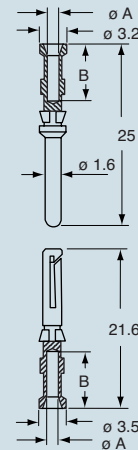

CDF and CDM contacts

conductor section mm ²	conductor slot ø A (mm)	B (mm)
0.14÷0.37	0.9	8
0.5	1.1	8
0.75	1.3	8
1.0	1.45	8
1.5	1.8	8
2.5	2.2	6

- stripping length see section feature of inserts on page 13

dimensions indicated are not binding and may be changed without notice

enclosures: **size "104.27"**

standard page: 212 ÷ 216
aggressive environments page: 223
EMC page: 224

panel supports:
COB page: 258 ÷ 259

- features according to EN 61984:
- 10A 250V 4kV 2**
- UL, CSA, CCC, GL certified
- for maximum current load, see the insert load curve section on page 29
- for applications with higher voltages, see the special voltage application section on page 52
- for contact crimping instructions, please see the crimping tool section (10A contacts, CDF and CDM series) on pages 296, 300, 304, 306, 308
- PCBs interface, see article CIF 2.4

inserts, crimp connections

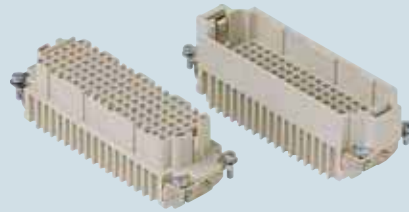

10A crimp contacts silver and gold plated



description

part No.

part No. part No.

without contacts (to be ordered separately)
 female inserts for female contacts
 male inserts for male contacts

CDDF 108
CDDM 108

10A female contacts

0.14÷0.37 mm ²	AWG 26÷22	identification No. 1
0.5 mm ²	AWG 20	identification No. 2
0.75 mm ²	AWG 18	identification No. ②
1 mm ²	AWG 18	identification No. 3
1.5 mm ²	AWG 16	identification No. 4
2.5 mm ²	AWG 14	identification No. 5

CDFA 0.3
CDFA 0.5
CDFA 0.7
CDFA 1.0
CDFA 1.5
CDFA 2.5

silver plated

CDFD 0.3
CDFD 0.5
CDFD 0.7
CDFD 1.0
CDFD 1.5
CDFD 2.5

gold plated

10A male contacts

0.14÷0.37 mm ²	AWG 26÷22	identification No. 1
0.5 mm ²	AWG 20	identification No. 2
0.75 mm ²	AWG 18	identification No. ②
1 mm ²	AWG 18	identification No. 3
1.5 mm ²	AWG 16	identification No. 4
2.5 mm ²	AWG 14	identification No. 5

CDMA 0.3
CDMA 0.5
CDMA 0.7
CDMA 1.0
CDMA 1.5
CDMA 2.5

CDMD 0.3
CDMD 0.5
CDMD 0.7
CDMD 1.0
CDMD 1.5
CDMD 2.5

dimensions in mm

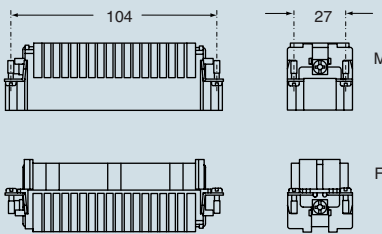

dimensions in mm

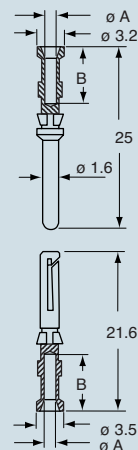

contacts side (front view)

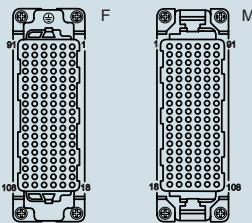

CDF and CDM contacts

conductor section mm ²	conductor slot ø A (mm)	B (mm)
0.14÷0.37	0.9	8
0.5	1.1	8
0.75	1.3	8
1.0	1.45	8
1.5	1.8	8
2.5	2.2	6

- stripping length see section feature of inserts on page 13

dimensions indicated are not binding and may be changed without notice

CDD

enclosures: **size "77.62"**

standard page: 226 ÷ 229

aggressive environments page: 230

- features according to EN 61984:

10A 250V 4kV 2

- UL, CSA, CCC, GL certified

- for maximum current load, see the insert load curve section on page 29

- for applications with higher voltages, see the special voltage application section on page 52

- for contact crimping instructions, please see the crimping tool section (10A contacts, CDF and CDM series) on pages 296, 300, 304, 306, 308

- PCBs interface, see article CIF 2.4

inserts, crimp connections

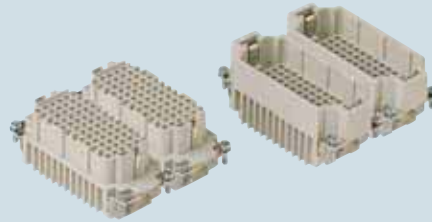

10A crimp contacts silver and gold plated



description	part No.	part No.	part No.	part No.
without contacts (to be ordered separately) female inserts, No. (1÷72) and (73÷144) male inserts, No. (1÷72) and (73÷144)	CDDF 72 CDDM 72	CDDF 72 N CDDM 72 N		
10A female contacts 0.14÷0.37 mm ² AWG 26÷22 identification No. 1 0.5 mm ² AWG 20 identification No. 2 0.75 mm ² AWG 18 identification No. ② 1 mm ² AWG 18 identification No. 3 1.5 mm ² AWG 16 identification No. 4 2.5 mm ² AWG 14 identification No. 5			CDFA 0.3 CDFA 0.5 CDFA 0.7 CDFA 1.0 CDFA 1.5 CDFA 2.5	CDFD 0.3 CDFD 0.5 CDFD 0.7 CDFD 1.0 CDFD 1.5 CDFD 2.5
10A male contacts 0.14÷0.37 mm ² AWG 26÷22 identification No. 1 0.5 mm ² AWG 20 identification No. 2 0.75 mm ² AWG 18 identification No. ② 1 mm ² AWG 18 identification No. 3 1.5 mm ² AWG 16 identification No. 4 2.5 mm ² AWG 14 identification No. 5			CDMA 0.3 CDMA 0.5 CDMA 0.7 CDMA 1.0 CDMA 1.5 CDMA 2.5	CDMD 0.3 CDMD 0.5 CDMD 0.7 CDMD 1.0 CDMD 1.5 CDMD 2.5

dimensions in mm

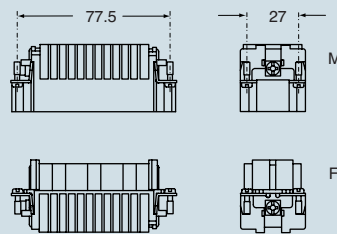

contacts side (front view)

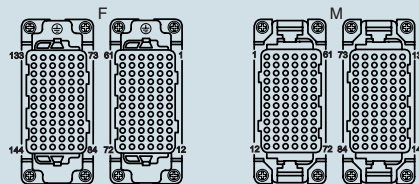

dimensions in mm

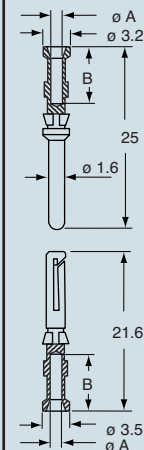

CDF and CDM contacts

conductor section mm ²	conductor slot ø A (mm)	B (mm)
0.14÷0.37	0.9	8
0.5	1.1	8
0.75	1.3	8
1.0	1.45	8
1.5	1.8	8
2.5	2.2	6

- stripping length see section feature of inserts on page 13

dimensions indicated are not binding and may be changed without notice

enclosures: **size "104.62"**

standard page: 232

aggressive environments page: 234

- features according to EN 61984:
- 10A 250V 4kV 2**
- UL, CSA, CCC, GL certified
- for maximum current load, see the insert load curve section on page 29
- for applications with higher voltages, see the special voltage application section on page 52
- for contact crimping instructions, please see the crimping tool section (10A contacts, CDF and CDM series) on page 296, 300, 304, 306, 308
- PCBs interface, see article CIF 2.4

inserts, crimp connections

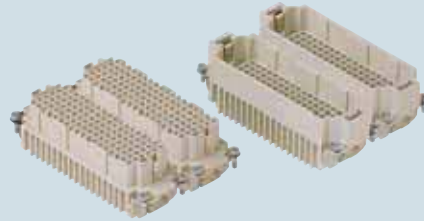

10A crimp contacts silver and gold plated



description	part No	part No..	part No.	part No.
without contacts (to be ordered separately) female inserts, No. (1÷108) and (109÷216) male inserts, No. (1÷108) and (109÷216)	CDDF 108 CDDM 108	CDDF 108 N CDDM 108 N		
10A female contacts 0.14÷0.37 mm ² AWG 26÷22 identification No. 1 0.5 mm ² AWG 20 identification No. 2 0.75 mm ² AWG 18 identification No. ② 1 mm ² AWG 18 identification No. 3 1.5 mm ² AWG 16 identification No. 4 2.5 mm ² AWG 14 identification No. 5			CDFA 0.3 CDFA 0.5 CDFA 0.7 CDFA 1.0 CDFA 1.5 CDFA 2.5	CDFD 0.3 CDFD 0.5 CDFD 0.7 CDFD 1.0 CDFD 1.5 CDFD 2.5
10A male contacts 0.14÷0.37 mm ² AWG 26÷22 identification No. 1 0.5 mm ² AWG 20 identification No. 2 0.75 mm ² AWG 18 identification No. ② 1 mm ² AWG 18 identification No. 3 1.5 mm ² AWG 16 identification No. 4 2.5 mm ² AWG 14 identification No. 5			CDMA 0.3 CDMA 0.5 CDMA 0.7 CDMA 1.0 CDMA 1.5 CDMA 2.5	CDMD 0.3 CDMD 0.5 CDMD 0.7 CDMD 1.0 CDMD 1.5 CDMD 2.5

silver plated

gold plated

dimensions in mm

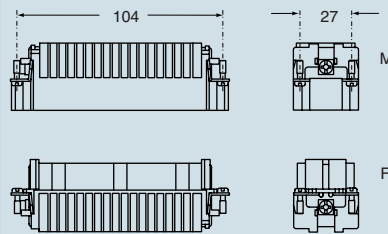

contacts side (front view)

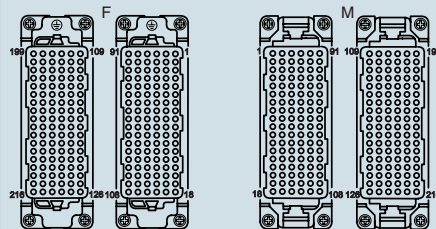

dimensions in mm

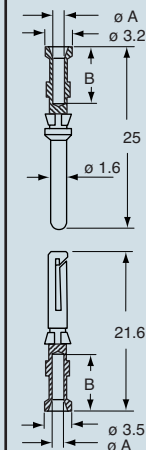

CDF and CDM contacts

conductor section mm ²	conductor slot ϕA (mm)	B (mm)
0.14÷0.37	0.9	8
0.5	1.1	8
0.75	1.3	8
1.0	1.45	8
1.5	1.8	8
2.5	2.2	6

- stripping length see section feature of inserts on page 13

dimensions indicated are not binding and may be changed without notice

CDD



Key position (M insert side)	Key position (F insert side)	View (M insert side)	View (M insert side)	View (F insert side)	View (F insert side)
A	B	A	B	B	A
1	1	▼	▼	▲	▲
1	2	▼	▲	▼	▲
1	3	▼	▼	▲	▲
1	4	▼	▲	▼	▲
2	1	▲	▼	▲	▼
2	2	▲	▲	▼	▼
2	3	▲	▼	▲	▼
2	4	▲	▲	▼	▼
3	1	▼	▼	▲	▲
3	2	▼	▲	▼	▲
3	3	▼	▼	▲	▲
3	4	▼	▲	▼	▲
4	1	▲	▼	▲	▼
4	2	▲	▲	▼	▼
4	3	▲	▼	▲	▼
4	4	▲	▲	▼	▼

CQ

enclosures: size "21.21"

insulating type page: 153 ÷ 154
 metallic type page: 155 ÷ 156
 aggressive environments page: 157
 EMC page: 158

- features according to EN 61984:
10A 400V 6kV 3
10A 400/690V 6kV 2
- certifications: (UL), (CSA); the certifications shown in brackets are being applied for
- for maximum current load, see the insert load curve section on page 30
- for contact crimping instructions, please see the crimping tool section (10A contacts, CDF and CDM series) on pages 296, 300, 304, 306, 308
- coding pins CR Q12

inserts, crimp connections



NEW

10A crimp contacts silver and gold plated



description	part No.	part No.	part No.
-------------	----------	----------	----------

without contacts (to be ordered separately)
 female inserts for female contacts
 male inserts for male contacts

CQF 12
CQM 12

10A female contacts

0.14÷0.37 mm ²	AWG 26÷22	identification No. 1
0.5 mm ²	AWG 20	identification No. 2
0.75 mm ²	AWG 18	identification No. ②
1 mm ²	AWG 18	identification No. 3
1.5 mm ²	AWG 16	identification No. 4
2.5 mm ²	AWG 14	identification No. 5

silver plated	CDFA 0.3	CDFD 0.3
	CDFA 0.5	CDFD 0.5
	CDFA 0.7	CDFD 0.7
	CDFA 1.0	CDFD 1.0
	CDFA 1.5	CDFD 1.5
	CDFA 2.5	CDFD 2.5
gold plated	CDMA 0.3	CDMD 0.3
	CDMA 0.5	CDMD 0.5
	CDMA 0.7	CDMD 0.7
	CDMA 1.0	CDMD 1.0
	CDMA 1.5	CDMD 1.5
	CDMA 2.5	CDMD 2.5

10A male contacts

0.14÷0.37 mm ²	AWG 26÷22	identification No. 1
0.5 mm ²	AWG 20	identification No. 2
0.75 mm ²	AWG 18	identification No. ②
1 mm ²	AWG 18	identification No. 3
1.5 mm ²	AWG 16	identification No. 4
2.5 mm ²	AWG 14	identification No. 5

Note:
 The CQ 12 inserts are already supplied with a seal and a screw, which ensure IP66/IP67 protection rating.
 The CR Q12 coding pins allow the user to create 16 different combinations, according to the diagram shown on page 271.

dimensions in mm

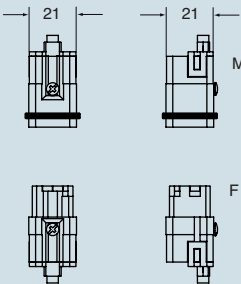

contacts side (front view)

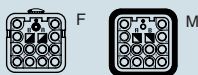

■ coding pins CR Q12 (to be ordered separately), page 271



dimensions in mm

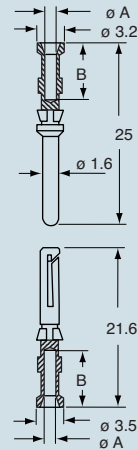

CDF and CDM contacts

conductor section mm ²	conductor slot ø A (mm)	B (mm)
0.14÷0.37	0.9	8
0.5	1.1	8
0.75	1.3	8
1.0	1.45	8
1.5	1.8	8
2.5	2.2	6

- stripping length see section feature of inserts on page 13

dimensions indicated are not binding and may be changed without notice

enclosures: **size "21.21"**

- insulating type** page: 153 ÷ 154
- metallic type** page: 155 ÷ 156
- aggressive environments** page: 157
- EMC** page: 158

- features according to EN 61984:
- 16A 230/400V 4kV 3**
- UL, CSA, CCC, GL certified
- for maximum current load, see the insert load curve section on page 30
- inserts and enclosures for applications with temperatures up to 180 °C, available on request
- for contact crimping instructions, please see the crimping tool section (16A contacts, CCF, CCM and CC...AN series) on pages 296, 300, 304, 306, 308
- coding pins CR Q12

inserts, crimp connections



16A crimp contacts normal and for advanced opening silver and gold plated



description	part No.	part No.	part No.
without contacts (to be ordered separately) female inserts for female contacts male inserts for male contacts	CQF 05 CQM 05		
16A female contacts 0.5 mm ² AWG 20 with no grooves 0.75 mm ² AWG 18 one groove (back side) 1 mm ² AWG 18 one groove 1.5 mm ² AWG 16 two grooves 2.5 mm ² AWG 14 three grooves 3 mm ² AWG 12 one wide groove 4 mm ² AWG 12 with no grooves		CCFA 0.5 CCFA 0.7 CCFA 1.0 CCFA 1.5 CCFA 2.5 CCFA 3.0 CCFA 4.0	CCFD 0.5 CCFD 0.7 CCFD 1.0 CCFD 1.5 CCFD 2.5 CCFD 3.0 CCFD 4.0
16A male contacts 0.5 mm ² AWG 20 with no grooves 0.75 mm ² AWG 18 one groove (back side) 1 mm ² AWG 18 one groove 1.5 mm ² AWG 16 two grooves 2.5 mm ² AWG 14 three grooves 3 mm ² AWG 12 one wide groove 4 mm ² AWG 12 with no grooves		CCMA 0.5 CCMA 0.7 CCMA 1.0 CCMA 1.5 CCMA 2.5 CCMA 3.0 CCMA 4.0	CCMD 0.5 CCMD 0.7 CCMD 1.0 CCMD 1.5 CCMD 2.5 CCMD 3.0 CCMD 4.0
16A male crimp contacts for advanced opening 0.5 mm ² AWG 20 with no grooves 0.75 mm ² AWG 18 one groove (back side) 1 mm ² AWG 18 one groove 1.5 mm ² AWG 16 two grooves 2.5 mm ² AWG 14 three grooves		CC 0.5 AN CC 0.7 AN CC 1.0 AN CC 1.5 AN CC 2.5 AN	

N.B.:
can also be used partially fitted with 4 mm² section contacts.

plug inserts with new, square shaped seal for IP44 and IP66/IP67 protection rating (see "21.21" size enclosures section from page 153)

dimensions in mm

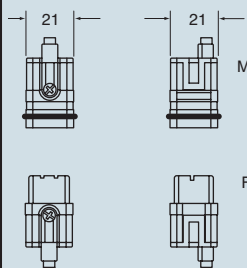

contacts side (front view)

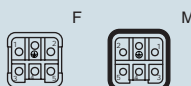

dimensions in mm

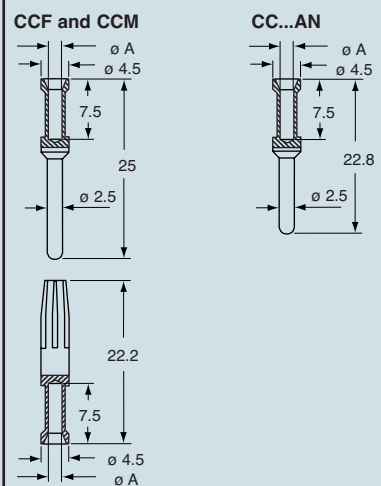

CCF, CCM and CC..AN contacts

conductor section mm ²	ø slot A (mm)
0.5	1.1
0.75	1.3
1.0	1.45
1.5	1.8
2.5	2.2
3	2.55
4	2.85

- stripping length see section feature of inserts on page 13

dimensions indicated are not binding and may be changed without notice

enclosures: **size "32.13"**

insulating type page: 160 ÷ 161

- features according to EN 61984:
16A 500V 6kV 3
16A 400/690V 6kV 2
- certifications: cUL for USA and Canada, CCC
- for contact crimping instructions, please see the crimping tool section (16A contacts, CCF, CCM series) on pages 296, 300, 304, 306, 308



compliant with ISO 23570-3 standard and with DESINA® specification

inserts, crimp connections



NEW

16A crimp contacts normal and for advanced opening silver and gold plated



description	part No.	part No.	part No.
-------------	----------	----------	----------

without contacts (to be ordered separately)
 female inserts for female contacts
 male inserts for male contacts

CQF 08
CQM 08

16A female contacts

0.5 mm ²	AWG 20	with no grooves
0.75 mm ²	AWG 18	one groove (back side)
1 mm ²	AWG 18	one groove
1.5 mm ²	AWG 16	two grooves
2.5 mm ²	AWG 14	three grooves
3 mm ²	AWG 12	one wide groove
4 mm ²	AWG 12	with no grooves

16A male contacts

0.5 mm ²	AWG 20	with no grooves
0.75 mm ²	AWG 18	one groove (back side)
1 mm ²	AWG 18	one groove
1.5 mm ²	AWG 16	two grooves
2.5 mm ²	AWG 14	three grooves
3 mm ²	AWG 12	one wide groove
4 mm ²	AWG 12	with no grooves

16A male crimp contacts for advanced opening

0.5 mm ²	AWG 20	with no grooves
0.75 mm ²	AWG 18	one groove (back side)
1 mm ²	AWG 18	one groove
1.5 mm ²	AWG 16	two grooves
2.5 mm ²	AWG 14	three grooves

CCFA 0.5
CCFA 0.7
CCFA 1.0
CCFA 1.5
CCFA 2.5
CCFA 3.0
CCFA 4.0

silver plated

CCFD 0.5
CCFD 0.7
CCFD 1.0
CCFD 1.5
CCFD 2.5
CCFD 3.0
CCFD 4.0

gold plated

CCMA 0.5
CCMA 0.7
CCMA 1.0
CCMA 1.5
CCMA 2.5
CCMA 3.0
CCMA 4.0

CCMD 0.5
CCMD 0.7
CCMD 1.0
CCMD 1.5
CCMD 2.5
CCMD 3.0
CCMD 4.0

CC 0.5 AN
CC 0.7 AN
CC 1.0 AN
CC 1.5 AN
CC 2.5 AN

N.B.: can also be used partially fitted with 4 mm² section contacts.

dimensions in mm

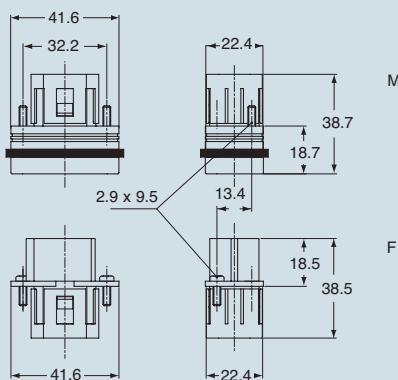

contacts side (front view)

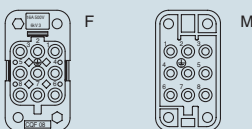

dimensions in mm

CCF and CCM

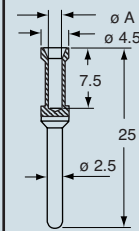

CC...AN

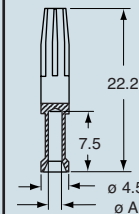
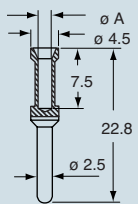

CCF, CCM and CC..AN contacts

conductor section mm ²	ø slot A (mm)
0.5	1.1
0.75	1.3
1.0	1.45
1.5	1.8
2.5	2.2
3	2.55
4	2.85

- stripping length see section feature of inserts on page 13

dimensions indicated are not binding and may be changed without notice

enclosures: **size "32.13"**

insulating type page: 160 ÷ 161

- features according to EN 61984:
4 poli 40A 400/690V 6kV 3
2 poli 10A 250V 4kV 3
- certifications: cUL for USA and Canada
- for contact crimping instructions, please see the crimping tool section (40A contacts, CXF, CXM series and 10A contacts CDF, CDM series) on pages 296, 298, 300, 304, 306, 308



compliant with ISO 23570-3 standard and with DESINA® specification

inserts, crimp connections

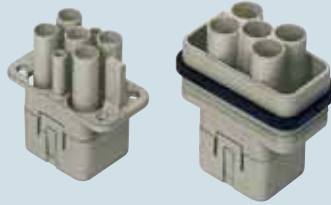

NEW

10A and 40A crimp contacts silver and gold plated



description	part No.	part No.	part No.
without contacts (to be ordered separately) female inserts for female contacts male inserts for male contacts	CQF 04/2 CQM 04/2		
40A female contacts 1.5 mm ² AWG 16 2.5 mm ² AWG 14 4 mm ² AWG 12 6 mm ² AWG 10		CXFA 1.5 CXFA 2.5 CXFA 4.0 CXFA 6.0	silver plated
40A male contacts 1.5 mm ² AWG 16 2.5 mm ² AWG 14 4 mm ² AWG 12 6 mm ² AWG 10		CXMA 1.5 CXMA 2.5 CXMA 4.0 CXMA 6.0	
10A female contacts 0.14÷0.37 mm ² AWG 26÷22 identification No. 1 0.5 mm ² AWG 20 identification No. 2 0.75 mm ² AWG 18 identification No. ② 1 mm ² AWG 18 identification No. 3 1.5 mm ² AWG 16 identification No. 4 2.5 mm ² AWG 14 identification No. 5		CDFA 0.3 CDFA 0.5 CDFA 0.7 CDFA 1.0 CDFA 1.5 CDFA 2.5	silver plated
10A male contacts 0.14÷0.37 mm ² AWG 26÷22 identification No. 1 0.5 mm ² AWG 20 identification No. 2 0.75 mm ² AWG 18 identification No. ② 1 mm ² AWG 18 identification No. 3 1.5 mm ² AWG 16 identification No. 4 2.5 mm ² AWG 14 identification No. 5		CDMA 0.3 CDMA 0.5 CDMA 0.7 CDMA 1.0 CDMA 1.5 CDMA 2.5	gold plated
		CDFD 0.3 CDFD 0.5 CDFD 0.7 CDFD 1.0 CDFD 1.5 CDFD 2.5	

CXF and CXM contacts

conductor section mm ²	Ø slot Ø A (mm)	B (mm)
1.5	1.75	9
2.5	2.25	9
4	2.85	9.6
6	3.5	9.6

- stripping length see section feature of inserts on page 13

CDF and CDM contacts

conductor section mm ²	conductor slot Ø A (mm)	B (mm)
0.14÷0.37	0.9	8
0.5	1.1	8
0.75	1.3	8
1.0	1.45	8
1.5	1.8	8
2.5	2.2	6

- stripping length see section feature of inserts on page 13

dimensions indicated are not binding and may be changed without notice

dimensions in mm

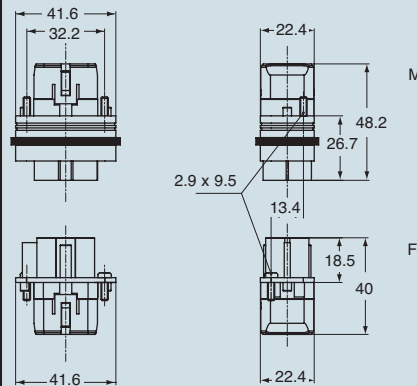

contacts side (front view)

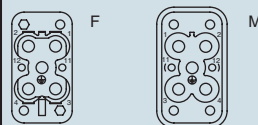

dimensions in mm

CXF and CXM CDF and CDM

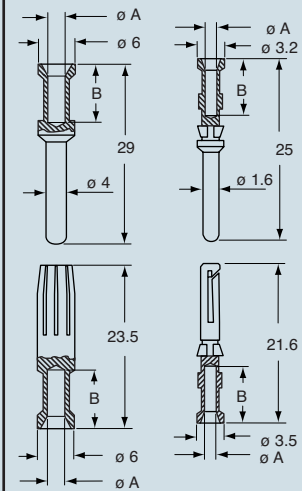

enclosures: **size "49.16"**

standard page: 162 ÷ 163
aggressive environments page: 164
EMC page: 165

panel supports:
COB + adaptor page: 258 ÷ 260

- features according to EN 61984:
- 16A 250V 4kV 3**
- UL, CSA, CCC, GL certified
- for maximum current load, see the insert load curve section on page 30

**inserts,
screw terminal connection**



**inserts,
screw terminal connection**

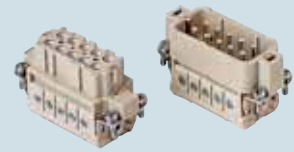

description

part No.

part No.

indirect, with plate ¹⁾
 female inserts with female contacts
 male inserts with male contacts

**CDAF 10
CDAM 10**

direct, without plate ²⁾
 female inserts with female contacts
 male inserts with male contacts

**CDAF 10 X
CDAM 10 X**

¹⁾ for non-prepared conductors

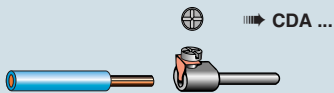

dimensions in mm

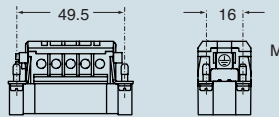

dimensions in mm

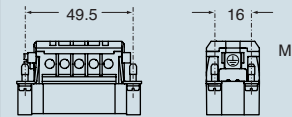

²⁾ for conductors with bush terminal

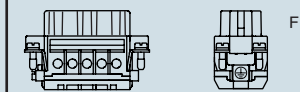
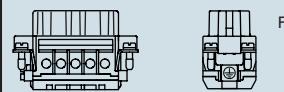
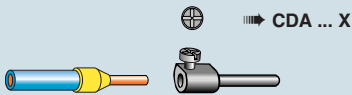

contacts side (front view)

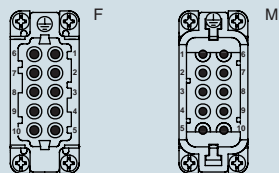

contacts side (front view)

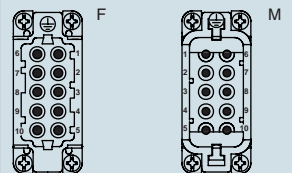

- inserts with plate for section conductors:
0.75 ÷ 2.5 mm² - AWG 18 ÷ 14
- torsion couple recommended for conductor fastening screws and stripping length see section feature of inserts on page 13

- inserts without plate for section prepared conductors:
0.25 ÷ 2.5 mm² - AWG 24 ÷ 14
- torsion couple recommended for conductor fastening screws see section feature of inserts on page 13

dimensions indicated are not binding
and may be changed without notice

CDA

enclosures: **size "49.16"**

standard page: 162 ÷ 163
aggressive environments page: 164
EMC page: 165

panel supports:
COB + adaptor page: 258 ÷ 260

- features according to EN 61984:
16A 250V 4kV 3
- UL, CSA, CCC, GL certified
- for maximum current load, see the insert load curve section on page 30
- for contact crimping instructions, please see the crimping tool section (16A contacts, CCF, CCM and CC...AN series) on pages 296, 300, 304, 306, 308

inserts, crimp connections



16A crimp contacts normal and for advanced opening silver and gold plated



description	part No.	part No.	part No.
without contacts (to be ordered separately) female inserts for female contacts male inserts for male contacts	CDCF 10 CDCM 10		
16A female contacts 0.5 mm ² AWG 20 with no grooves 0.75 mm ² AWG 18 one groove (back side) 1 mm ² AWG 18 one groove 1.5 mm ² AWG 16 two grooves 2.5 mm ² AWG 14 three grooves 3 mm ² AWG 12 one wide groove 4 mm ² AWG 12 with no grooves		CCFA 0.5 CCFA 0.7 CCFA 1.0 CCFA 1.5 CCFA 2.5 CCFA 3.0 CCFA 4.0	CCFD 0.5 CCFD 0.7 CCFD 1.0 CCFD 1.5 CCFD 2.5 CCFD 3.0 CCFD 4.0
16A male contacts 0.5 mm ² AWG 20 with no grooves 0.75 mm ² AWG 18 one groove (back side) 1 mm ² AWG 18 one groove 1.5 mm ² AWG 16 two grooves 2.5 mm ² AWG 14 three grooves 3 mm ² AWG 12 one wide groove 4 mm ² AWG 12 with no grooves		CCMA 0.5 CCMA 0.7 CCMA 1.0 CCMA 1.5 CCMA 2.5 CCMA 3.0 CCMA 4.0	CCMD 0.5 CCMD 0.7 CCMD 1.0 CCMD 1.5 CCMD 2.5 CCMD 3.0 CCMD 4.0
16A male crimp contacts for advanced opening 0.5 mm ² AWG 20 with no grooves 0.75 mm ² AWG 18 one groove (back side) 1 mm ² AWG 18 one groove 1.5 mm ² AWG 16 two grooves 2.5 mm ² AWG 14 three grooves		CC 0.5 AN CC 0.7 AN CC 1.0 AN CC 1.5 AN	

dimensions in mm

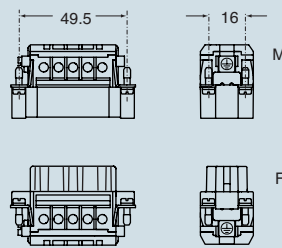

contacts side (front view)

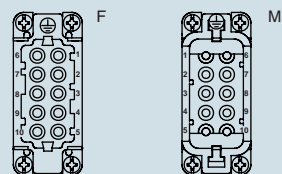

dimensions in mm

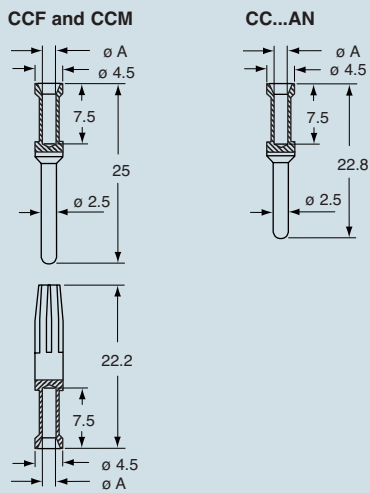

CCF, CCM and CC..AN contacts

conductor section mm ²	ø slot A (mm)
0.5	1.1
0.75	1.3
1.0	1.45
1.5	1.8
2.5	2.2
3	2.55
4	2.85

dimensions indicated are not binding and may be changed without notice

- stripping length see section feature of inserts on page 13

enclosures: **size "66.16"**

standard page: 166 ÷ 167
aggressive environments page: 168
EMC page: 169

panel supports:
COB + adaptor page: 258 ÷ 260

- features according to EN 61984:
16A 250V 4kV 3
 - UL, CSA, CCC, GL certified
 - for maximum current load, see the insert load curve section on page 30

**inserts,
 screw terminal connection**



**inserts,
 screw terminal connection**



description

part No.

part No.

indirect, with plate ¹⁾
 female inserts with female contacts
 male inserts with male contacts

**CDAF 16
 CDAM 16**

direct, without plate ²⁾
 female inserts with female contacts
 male inserts with male contacts

**CDAF 16 X
 CDAM 16 X**

¹⁾ for non-prepared conductors

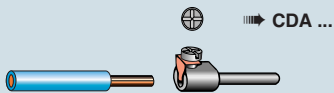

dimensions in mm

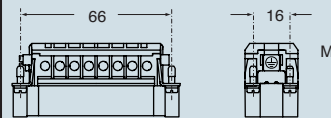

dimensions in mm

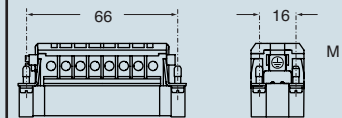

²⁾ for conductors with bush terminal

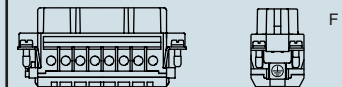
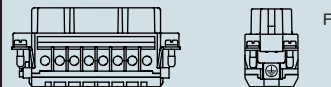
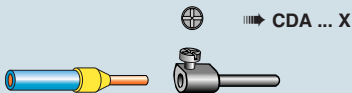

contacts side (front view)

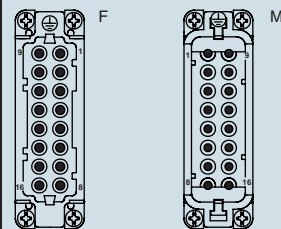

contacts side (front view)

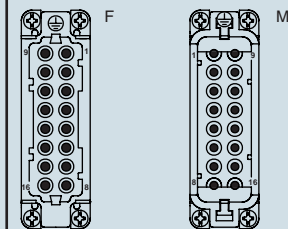

- inserts with plate for section conductors:
 0.75 ÷ 2.5 mm² - AWG 18 ÷ 14
 - torsion couple recommended for conductor fastening screws and stripping length see section feature of inserts on page 13

- inserts without plate for section prepared conductors:
 0.25 ÷ 2.5 mm² - AWG 24 ÷ 14
 - torsion couple recommended for conductor fastening screws see section feature of inserts on page 13

dimensions indicated are not binding
 and may be changed without notice

CDA

enclosures: **size "66.16"**

standard page: 166 ÷ 167
aggressive environments page: 168
EMC page: 169

panel supports:
COB + adaptor..... pag.: 258 ÷ 260

- features according to EN 61984:
16A 250V 4kV 3
- UL, CSA, CCC, GL certified
- for maximum current load, see the insert load curve section on page 30
- for contact crimping instructions, please see the crimping tool section (16A contacts, CCF, CCM and CC...AN series) on pages 296, 300, 304, 306, 308

inserts, crimp connections

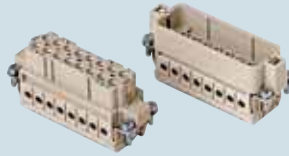

16A crimp contacts normal and for advanced opening silver and gold plated



description	part No.	part No.	part No.
without contacts (to be ordered separately) female inserts for female contacts male inserts for male contacts	CDCF 16 CDCM 16		
16A female contacts 0.5 mm ² AWG 20 with no grooves 0.75 mm ² AWG 18 one groove (back side) 1 mm ² AWG 18 one groove 1.5 mm ² AWG 16 two grooves 2.5 mm ² AWG 14 three grooves 3 mm ² AWG 12 one wide groove 4 mm ² AWG 12 with no grooves		CCFA 0.5 CCFA 0.7 CCFA 1.0 CCFA 1.5 CCFA 2.5 CCFA 3.0 CCFA 4.0	CCFD 0.5 CCFD 0.7 CCFD 1.0 CCFD 1.5 CCFD 2.5 CCFD 3.0 CCFD 4.0
16A male contacts 0.5 mm ² AWG 20 with no grooves 0.75 mm ² AWG 18 one groove (back side) 1 mm ² AWG 18 one groove 1.5 mm ² AWG 16 two grooves 2.5 mm ² AWG 14 three grooves 3 mm ² AWG 12 one wide groove 4 mm ² AWG 12 with no grooves		CCMA 0.5 CCMA 0.7 CCMA 1.0 CCMA 1.5 CCMA 2.5 CCMA 3.0 CCMA 4.0	CCMD 0.5 CCMD 0.7 CCMD 1.0 CCMD 1.5 CCMD 2.5 CCMD 3.0 CCMD 4.0
16A male crimp contacts for advanced opening 0.5 mm ² AWG 20 with no grooves 0.75 mm ² AWG 18 one groove (back side) 1 mm ² AWG 18 one groove 1.5 mm ² AWG 16 two grooves 2.5 mm ² AWG 14 three grooves		CC 0.5 AN CC 0.7 AN CC 1.0 AN CC 1.5 AN CC 2.5 AN	

silver plated

gold plated

dimensions in mm

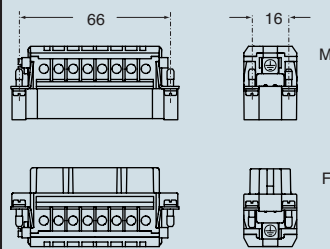

contacts side (front view)

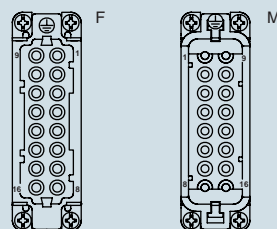

dimensions in mm

CCF and CCM

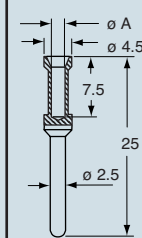

CC...AN

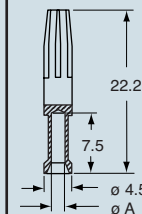
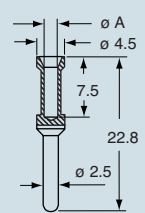

CCF, CCM and CC..AN contacts

conductor section mm ²	ø slot A (mm)
0.5	1.1
0.75	1.3
1.0	1.45
1.5	1.8
2.5	2.2
3	2.55
4	2.85

dimensions indicated are not binding and may be changed without notice

- stripping length see section feature of inserts on page 13

CDC

enclosures: size "66.40"

standard page: 171 ÷ 173

aggressive environments page: 174

- features according to EN 61984:
- 16A 250V 4kV 3**
- UL, CSA, CCC, GL certified
- for maximum current load, see the insert load curve section on page 30

inserts,
screw terminal connection

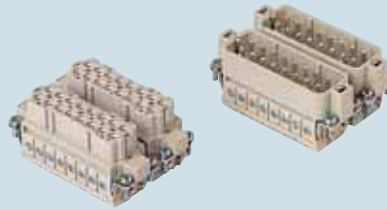

inserts,
screw terminal connection

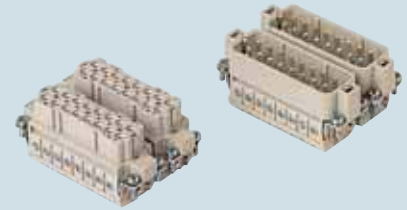

description	part No.	part No.	part No.	part No.
indirect, with plate ¹⁾ female inserts, No. (1÷16) and (17÷32) male inserts, No. (1÷16) and (17÷32)	CDAF 16 CDAM 16	CDAF 16 N CDAM 16 N	CDAF 16 X CDAM 16 X	CDAF 16 XN CDAM 16 XN
direct, without plate ²⁾ female inserts, No. (1÷16) and (17÷32) male inserts, No. (1÷16) and (17÷32)				

¹⁾ for non-prepared conductors

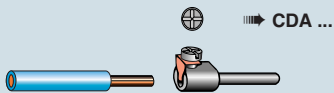

²⁾ for conductors with bush terminal

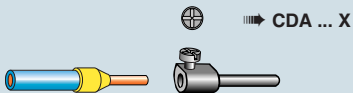

dimensions in mm

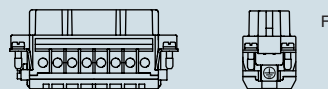
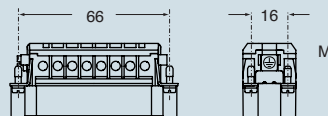

contacts side (front view)

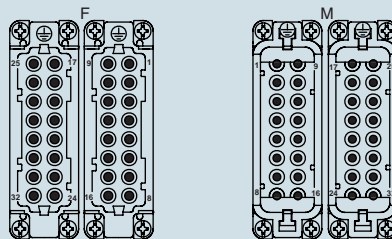

dimensions in mm

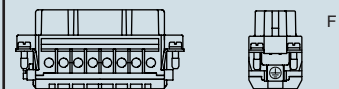
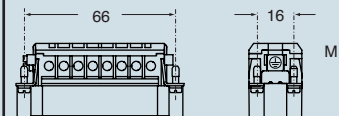

contacts side (front view)

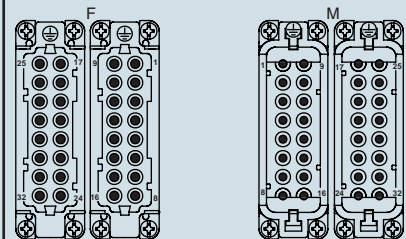

- inserts with plate for section conductors:
0.75 ÷ 2.5 mm² - AWG 18 ÷ 14
- torsion couple recommended for conductor fastening screws and stripping length see section feature of inserts on page 13

- inserts without plate for section prepared conductors:
0.25 ÷ 2.5 mm² - AWG 24 ÷ 14
- torsion couple recommended for conductor fastening screws see section feature of inserts on page 13

dimensions indicated are not binding
and may be changed without notice

CDA

enclosures: size "66.40"

standard page: 171 ÷ 173

aggressive environments page: 174

- features according to EN 61984:

16A 250V 4kV 3

- UL, CSA, CCC, GL certified
- for maximum current load, see the insert load curve section on page 30
- for contact crimping instructions, please see the crimping tool section (16A contacts, CCF, CCM and CC...AN series) on pages 296, 300, 304, 306, 308

inserts, crimp connections

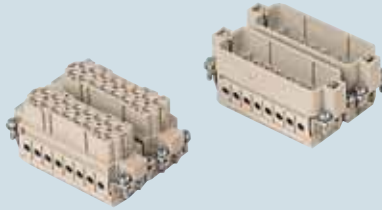

16A crimp contacts normal and for advanced opening silver and gold plated



description	part No.	part No.	part No.	part No.
without contacts (to be ordered separately) female inserts, No. (1÷16) and (17÷32) male inserts, No. (1÷16) and (17÷32)	CDCF 16 CDCM 16	CDCF 16 N CDCM 16 N		
16A female contacts 0.5 mm ² AWG 20 with no grooves 0.75 mm ² AWG 18 one groove (back side) 1 mm ² AWG 18 one groove 1.5 mm ² AWG 16 two grooves 2.5 mm ² AWG 14 three grooves 3 mm ² AWG 12 one wide groove 4 mm ² AWG 12 with no grooves			CCFA 0.5 CCFA 0.7 CCFA 1.0 CCFA 1.5 CCFA 2.5 CCFA 3.0 CCFA 4.0	CCFD 0.5 CCFD 0.7 CCFD 1.0 CCFD 1.5 CCFD 2.5 CCFD 3.0 CCFD 4.0
16A male contacts 0.5 mm ² AWG 20 with no grooves 0.75 mm ² AWG 18 one groove (back side) 1 mm ² AWG 18 one groove 1.5 mm ² AWG 16 two grooves 2.5 mm ² AWG 14 three grooves 3 mm ² AWG 12 one wide groove 4 mm ² AWG 12 with no grooves			CCMA 0.5 CCMA 0.7 CCMA 1.0 CCMA 1.5 CCMA 2.5 CCMA 3.0 CCMA 4.0	CCMD 0.5 CCMD 0.7 CCMD 1.0 CCMD 1.5 CCMD 2.5 CCMD 3.0 CCMD 4.0
16A male crimp contacts for advanced opening 0.5 mm ² AWG 20 with no grooves 0.75 mm ² AWG 18 one groove (back side) 1 mm ² AWG 18 one groove 1.5 mm ² AWG 16 two grooves 2.5 mm ² AWG 14 three grooves			CC 0.5 AN CC 0.7 AN CC 1.0 AN CC 1.5 AN CC 2.5 AN	

dimensions in mm

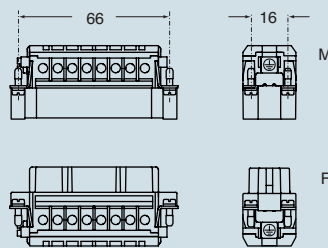

contacts side (front view)

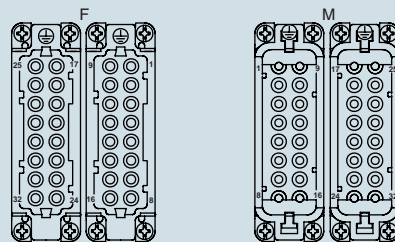

dimensions in mm

CCF and CCM

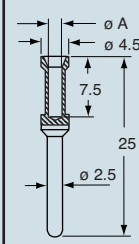

CC...AN

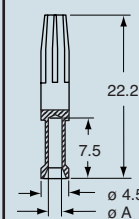
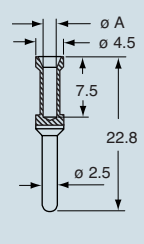

CCF, CCM and CC...AN contacts

conductor section mm ²	ø slot A (mm)
0.5	1.1
0.75	1.3
1.0	1.45
1.5	1.8
2.5	2.2
3	2.55
4	2.85

- stripping length see section feature of inserts on page 13

dimensions indicated are not binding and may be changed without notice

CDC

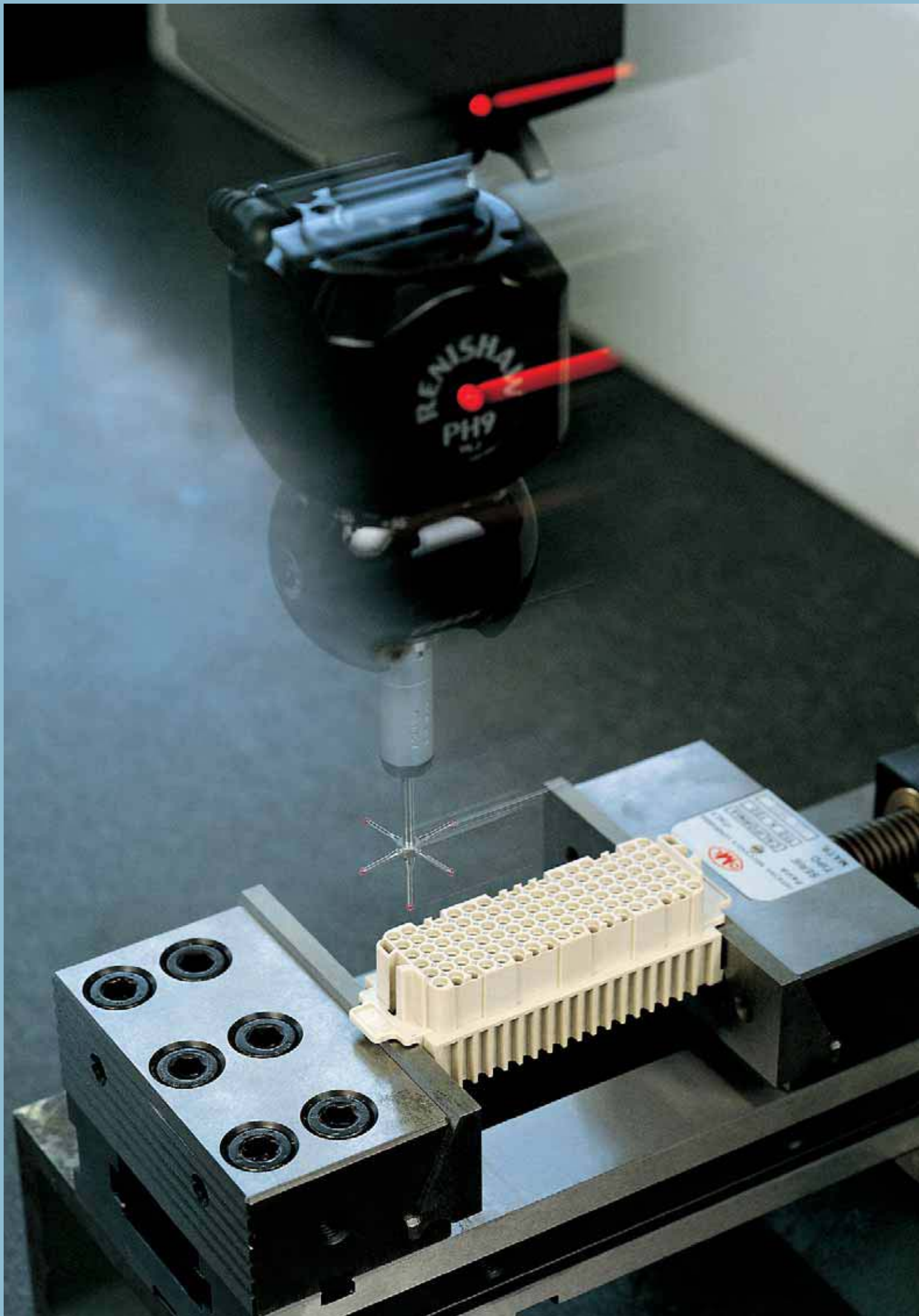

When all the contacts are used, the CQE inserts series connectors may be used with voltages of up to 500V (first column) pollution degree 3, in accordance with the standard EN 61984.
 If the number of contacts is reduced and the contacts accordingly assigned, these connectors may be used with higher voltages. This is possible because the decrease in the number of contacts leads to an increase in the surface insulation distance in the air. When the contacts are arranged as shown below, the inserts may be used for voltages of 690V (second column) and 1000V (third column) pollution degree 3, in accordance with the standard EN 61984.

Legend:

- working contact
- without contact
- M = male insert
- F = female insert

for use up to 500V
pollution degree 3

diagrams
contacts side (front view)

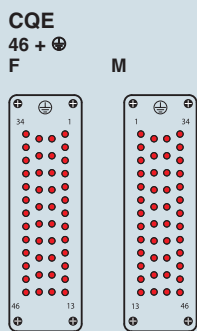
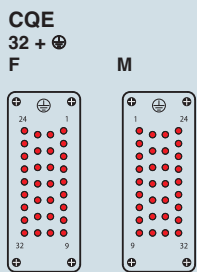
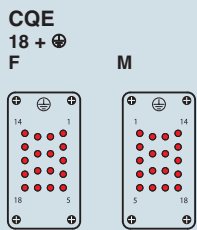
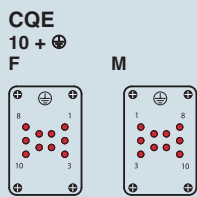

for use up to 690V
pollution degree 3

diagrams
contacts side (front view)

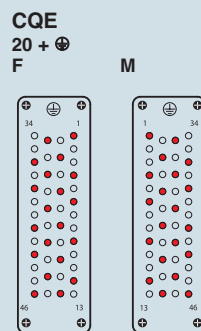
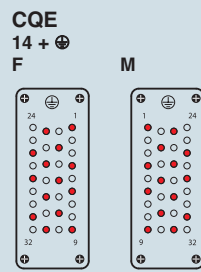
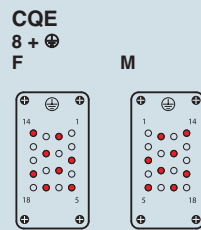
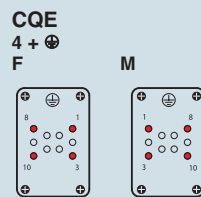

for use up to 1000V
pollution degree 3

diagrams
contacts side (front view)

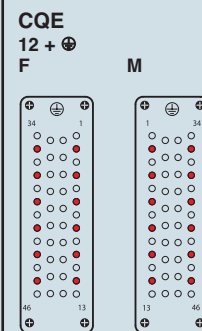
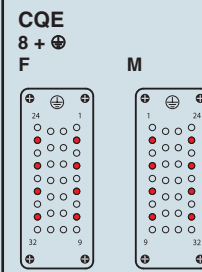
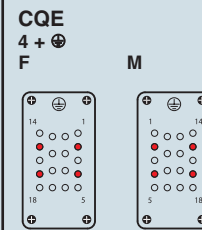
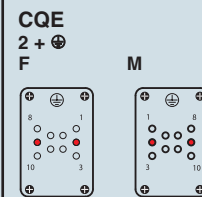

enclosures: **size "44.27"**

standard page: 176 ÷ 179
aggressive environments page: 181
EMC page: 182

panel supports:

COB page: 258 ÷ 259

- features according to EN 61984:
16A 500V 6kV 3
- UL, CSA, CCC, GL certified
- for maximum current load, see the insert load curve section on page 30
- for contact crimping instructions, please see the crimping tool section (16A contacts, CCF, CCM and CC...AN series) on page 296, 300, 304, 306, 308

inserts, crimp connections



16A crimp contacts normal and for advanced opening silver and gold plated



description	part No.	part No.	part No.
without contacts (to be ordered separately) female inserts for female contacts male inserts for male contacts	CQEF 10 CQEM 10		
16A female contacts 0.5 mm ² AWG 20 with no grooves 0.75 mm ² AWG 18 one groove (back side) 1 mm ² AWG 18 one groove 1.5 mm ² AWG 16 two grooves 2.5 mm ² AWG 14 three grooves 3 mm ² AWG 12 one wide groove 4 mm ² AWG 12 with no grooves		silver plated	gold plated
16A male contacts 0.5 mm ² AWG 20 with no grooves 0.75 mm ² AWG 18 one groove (back side) 1 mm ² AWG 18 one groove 1.5 mm ² AWG 16 two grooves 2.5 mm ² AWG 14 three grooves 3 mm ² AWG 12 one wide groove 4 mm ² AWG 12 with no grooves		silver plated	gold plated
16A male crimp contacts for advanced opening 0.5 mm ² AWG 20 with no grooves 0.75 mm ² AWG 18 one groove (back side) 1 mm ² AWG 18 one groove 1.5 mm ² AWG 16 two grooves 2.5 mm ² AWG 14 three grooves		silver plated	gold plated
		CCFA 0.5 CCFA 0.7 CCFA 1.0 CCFA 1.5 CCFA 2.5 CCFA 3.0 CCFA 4.0	CCFD 0.5 CCFD 0.7 CCFD 1.0 CCFD 1.5 CCFD 2.5 CCFD 3.0 CCFD 4.0
		CCMA 0.5 CCMA 0.7 CCMA 1.0 CCMA 1.5 CCMA 2.5 CCMA 3.0 CCMA 4.0	CCMD 0.5 CCMD 0.7 CCMD 1.0 CCMD 1.5 CCMD 2.5 CCMD 3.0 CCMD 4.0
		CC 0.5 AN CC 0.7 AN CC 1.0 AN CC 1.5 AN CC 2.5 AN	

dimensions in mm

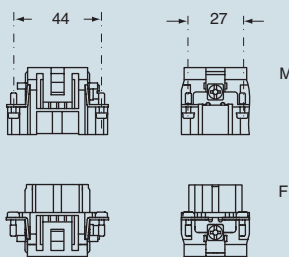

contacts side (front view)

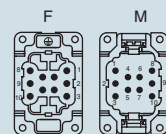

dimensions in mm

CCF and CCM CC...AN

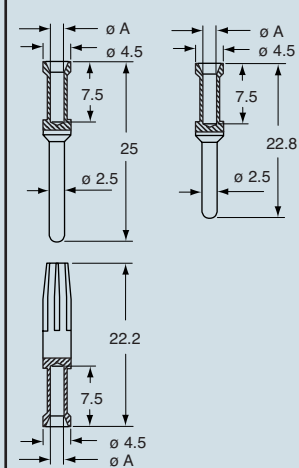

CCF, CCM and CC..AN contacts

conductor section mm ²	ø slot A (mm)
0.5	1.1
0.75	1.3
1.0	1.45
1.5	1.8
2.5	2.2
3	2.55
4	2.85

dimensions indicated are not binding and may be changed without notice

- stripping length see section feature of inserts on page 13

enclosures: **size "57.27"**

standard page: 184 ÷ 188
aggressive environments page: 195
EMC page: 196

panel supports:

COB page: 258 ÷ 259

- features according to EN 61984:

16A 500V 6kV 3

- UL, CSA, CCC, GL certified
- for maximum current load, see the insert load curve section on page 30
- for contact crimping instructions, please see the crimping tool section (16A contacts, CCF, CCM and CC...AN series) on pages 296, 300, 304, 306, 308

inserts, crimp connections

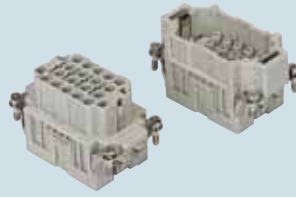

16A crimp contacts normal and for advanced opening silver and gold plated



description	part No.	part No.	part No.
without contacts (to be ordered separately) female inserts for female contacts male inserts for male contacts	CQEF 18 CQEM 18		
16A female contacts 0.5 mm ² AWG 20 with no grooves 0.75 mm ² AWG 18 one groove (back side) 1 mm ² AWG 18 one groove 1.5 mm ² AWG 16 two grooves 2.5 mm ² AWG 14 three grooves 3 mm ² AWG 12 one wide groove 4 mm ² AWG 12 with no grooves 16A male contacts 0.5 mm ² AWG 20 with no grooves 0.75 mm ² AWG 18 one groove (back side) 1 mm ² AWG 18 one groove 1.5 mm ² AWG 16 two grooves 2.5 mm ² AWG 14 three grooves 3 mm ² AWG 12 one wide groove 4 mm ² AWG 12 with no grooves		CCFA 0.5 CCFA 0.7 CCFA 1.0 CCFA 1.5 CCFA 2.5 CCFA 3.0 CCFA 4.0 CCMA 0.5 CCMA 0.7 CCMA 1.0 CCMA 1.5 CCMA 2.5 CCMA 3.0 CCMA 4.0	CCFD 0.5 CCFD 0.7 CCFD 1.0 CCFD 1.5 CCFD 2.5 CCFD 3.0 CCFD 4.0 CCMD 0.5 CCMD 0.7 CCMD 1.0 CCMD 1.5 CCMD 2.5 CCMD 3.0 CCMD 4.0
16A male crimp contacts for advanced opening 0.5 mm ² AWG 20 with no grooves 0.75 mm ² AWG 18 one groove (back side) 1 mm ² AWG 18 one groove 1.5 mm ² AWG 16 two grooves 2.5 mm ² AWG 14 three grooves		CC 0.5 AN CC 0.7 AN CC 1.0 AN CC 1.5 AN CC 2.5 AN	

dimensions in mm

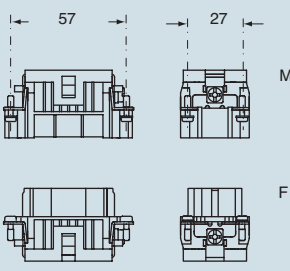

contacts side (front view)

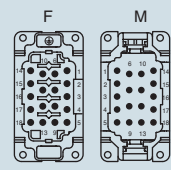

dimensions in mm

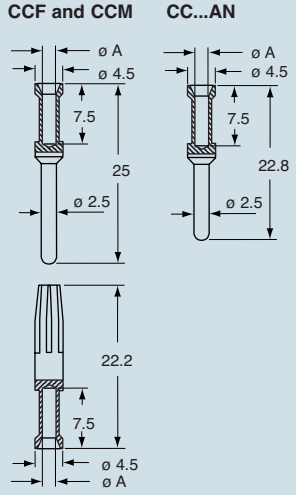

CCF, CCM and CC..AN contacts

conductor section mm ²	ø slot A (mm)
0.5	1.1
0.75	1.3
1.0	1.45
1.5	1.8
2.5	2.2
3	2.55
4	2.85

dimensions indicated are not binding and may be changed without notice

- stripping length see section feature of inserts on page 13

enclosures: **size "77.27"**

standard page: 198 ÷ 202
aggressive environments page: 209
EMC page: 210

panel supports:

COB page: 258 ÷ 259

- features according to EN 61984:
16A 500V 6kV 3
- UL, CSA, CCC, GL certified
- for maximum current load, see the insert load curve section on page 30
- for contact crimping instructions, please see the crimping tool section (16A contacts, CCF, CCM and CC...AN series) on pages 296, 300, 304, 306, 308

inserts, crimp connections

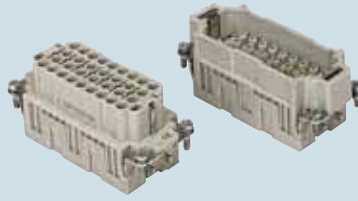

16A crimp contacts normal and for advanced opening silver and gold plated



description	part No.	part No.	part No.
without contacts (to be ordered separately) female inserts for female contacts male inserts for male contacts	CQEF 32 CQEM 32		
16A female contacts 0.5 mm ² AWG 20 with no grooves 0.75 mm ² AWG 18 one groove (back side) 1 mm ² AWG 18 one groove 1.5 mm ² AWG 16 two grooves 2.5 mm ² AWG 14 three grooves 3 mm ² AWG 12 one wide groove 4 mm ² AWG 12 with no grooves		CCFA 0.5 CCFA 0.7 CCFA 1.0 CCFA 1.5 CCFA 2.5 CCFA 3.0 CCFA 4.0	CCFD 0.5 CCFD 0.7 CCFD 1.0 CCFD 1.5 CCFD 2.5 CCFD 3.0 CCFD 4.0
16A male contacts 0.5 mm ² AWG 20 with no grooves 0.75 mm ² AWG 18 one groove (back side) 1 mm ² AWG 18 one groove 1.5 mm ² AWG 16 two grooves 2.5 mm ² AWG 14 three grooves 3 mm ² AWG 12 one wide groove 4 mm ² AWG 12 with no grooves		CCMA 0.5 CCMA 0.7 CCMA 1.0 CCMA 1.5 CCMA 2.5 CCMA 3.0 CCMA 4.0	CCMD 0.5 CCMD 0.7 CCMD 1.0 CCMD 1.5 CCMD 2.5 CCMD 3.0 CCMD 4.0
16A male crimp contacts for advanced opening 0.5 mm ² AWG 20 with no grooves 0.75 mm ² AWG 18 one groove (back side) 1 mm ² AWG 18 one groove 1.5 mm ² AWG 16 two grooves 2.5 mm ² AWG 14 three grooves		CC 0.5 AN CC 0.7 AN CC 1.0 AN CC 1.5 AN CC 2.5 AN	

silver plated

gold plated

dimensions in mm

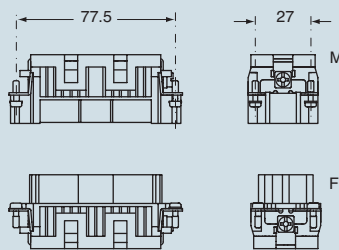

contacts side (front view)

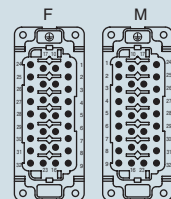

dimensions in mm

CCF and CCM CC...AN

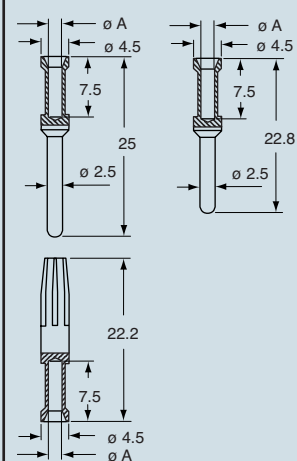

CCF, CCM and CC..AN contacts

conductor section mm ²	ø slot A (mm)
0.5	1.1
0.75	1.3
1.0	1.45
1.5	1.8
2.5	2.2
3	2.55
4	2.85

dimensions indicated are not binding and may be changed without notice

- stripping length see section feature of inserts on page 13

enclosures: **size "104.27"**

standard page: 212 ÷ 216
aggressive environments page: 223
EMC page: 224

panel supports:
COB page: 258 ÷ 259

- features according to EN 61984:
16A 500V 6kV 3
- UL, CSA, CCC, GL certified
- for maximum current load, see the insert load curve section on page 30
- for contact crimping instructions, please see the crimping tool section (16A contacts, CCF, CCM and CC...AN series) on page 296, 300, 304, 306, 308

inserts, crimp connections

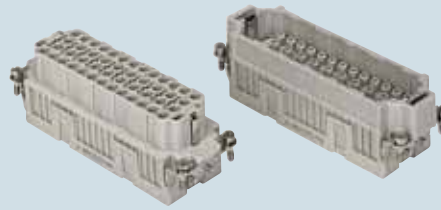

16A crimp contacts normal and for advanced opening silver and gold plated



description	part No.	part No.	part No.
without contacts (to be ordered separately) female inserts for female contacts male inserts for male contacts	CQEF 46 CQEM 46		
16A female contacts 0.5 mm ² AWG 20 with no grooves 0.75 mm ² AWG 18 one groove (back side) 1 mm ² AWG 18 one groove 1.5 mm ² AWG 16 two grooves 2.5 mm ² AWG 14 three grooves 3 mm ² AWG 12 one wide groove 4 mm ² AWG 12 with no grooves 16A male contacts 0.5 mm ² AWG 20 with no grooves 0.75 mm ² AWG 18 one groove (back side) 1 mm ² AWG 18 one groove 1.5 mm ² AWG 16 two grooves 2.5 mm ² AWG 14 three grooves 3 mm ² AWG 12 one wide groove 4 mm ² AWG 12 with no grooves		CCFA 0.5 CCFA 0.7 CCFA 1.0 CCFA 1.5 CCFA 2.5 CCFA 3.0 CCFA 4.0	CCFD 0.5 CCFD 0.7 CCFD 1.0 CCFD 1.5 CCFD 2.5 CCFD 3.0 CCFD 4.0 CCMA 0.5 CCMA 0.7 CCMA 1.0 CCMA 1.5 CCMA 2.5 CCMA 3.0 CCMA 4.0 CCMD 0.5 CCMD 0.7 CCMD 1.0 CCMD 1.5 CCMD 2.5 CCMD 3.0 CCMD 4.0
16A male crimp contacts for advanced opening 0.5 mm ² AWG 20 with no grooves 0.75 mm ² AWG 18 one groove (back side) 1 mm ² AWG 18 one groove 1.5 mm ² AWG 16 two grooves 2.5 mm ² AWG 14 three grooves		CC 0.5 AN CC 0.7 AN CC 1.0 AN CC 1.5 AN CC 2.5 AN	

dimensions in mm

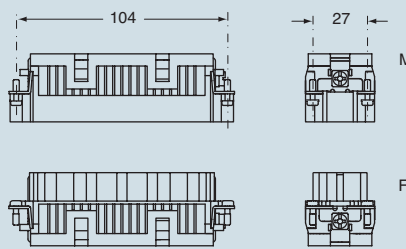

contacts side (front view)

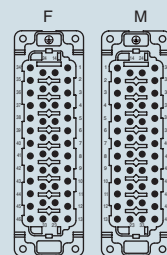

dimensions in mm

CCF and CCM CC...AN

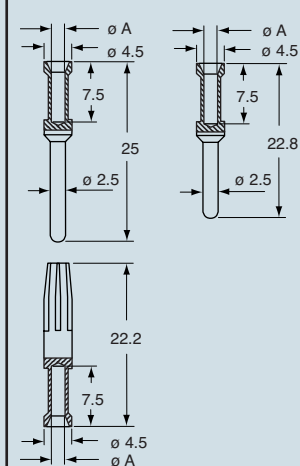

CCF, CCM and CC..AN contacts

conductor section mm ²	ø slot A (mm)
0.5	1.1
0.75	1.3
1.0	1.45
1.5	1.8
2.5	2.2
3	2.55
4	2.85

dimensions indicated are not binding and may be changed without notice

- stripping length see section feature of inserts on page 13

enclosures: size "77.62"

standard page: 226 ÷ 229

aggressive environments page: 230

- features according to EN 61984:
- 16A 500V 6kV 3**
- UL, CSA, CCC, GL certified
- for maximum current load, see the insert load curve section on page 30
- for contact crimping instructions, please see the crimping tool section (16A contacts, CCF, CCM and CC...AN series) on pages 296, 300, 304, 306, 308

inserts, crimp connections

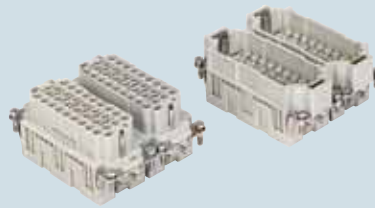

16A crimp contacts normal and for advanced opening silver and gold plated



description	part No.	part No.	part No.	part No.
without contacts (to be ordered separately) female inserts, No. (1÷32) and (33÷64) male inserts, No. (1÷32) and (33÷64)	CQEF 32 CQEM 32	CQEF 32 N CQEM 32 N		
16A female contacts 0.5 mm ² AWG 20 with no grooves 0.75 mm ² AWG 18 one groove (back side) 1 mm ² AWG 18 one groove 1.5 mm ² AWG 16 two grooves 2.5 mm ² AWG 14 three grooves 3 mm ² AWG 12 one wide groove 4 mm ² AWG 12 with no grooves			CCFA 0.5 CCFA 0.7 CCFA 1.0 CCFA 1.5 CCFA 2.5 CCFA 3.0 CCFA 4.0	CCFD 0.5 CCFD 0.7 CCFD 1.0 CCFD 1.5 CCFD 2.5 CCFD 3.0 CCFD 4.0
16A male contacts 0.5 mm ² AWG 20 with no grooves 0.75 mm ² AWG 18 one groove (back side) 1 mm ² AWG 18 one groove 1.5 mm ² AWG 16 two grooves 2.5 mm ² AWG 14 three grooves 3 mm ² AWG 12 one wide groove 4 mm ² AWG 12 with no grooves			CCMA 0.5 CCMA 0.7 CCMA 1.0 CCMA 1.5 CCMA 2.5 CCMA 3.0 CCMA 4.0	CCMD 0.5 CCMD 0.7 CCMD 1.0 CCMD 1.5 CCMD 2.5 CCMD 3.0 CCMD 4.0
16A male crimp contacts for advanced opening 0.5 mm ² AWG 20 with no grooves 0.75 mm ² AWG 18 one groove (back side) 1 mm ² AWG 18 one groove 1.5 mm ² AWG 16 two grooves 2.5 mm ² AWG 14 three grooves			CC 0.5 AN CC 0.7 AN CC 1.0 AN CC 1.5 AN CC 2.5 AN	

silver plated

gold plated

dimensions in mm

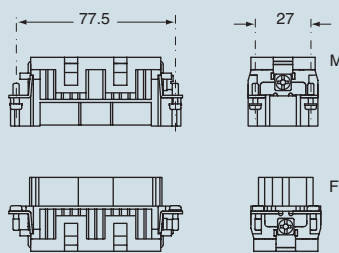

contacts side (front view)

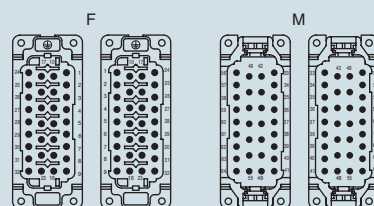

dimensions in mm

CCF and CCM CC...AN

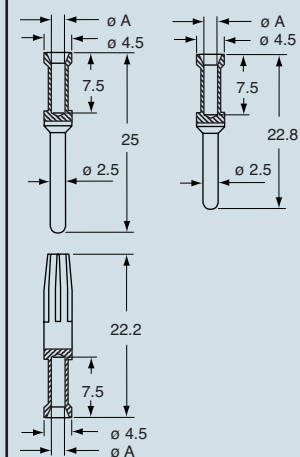

CCF, CCM and CC..AN contacts

conductor section mm ²	ø slot A (mm)
0.5	1.1
0.75	1.3
1.0	1.45
1.5	1.8
2.5	2.2
3	2.55
4	2.85

dimensions indicated are not binding and may be changed without notice

- stripping length see section feature of inserts on apage 13

enclosures: **size "104.62"**

standard page: 232

aggressive environments page: 234

- features according to EN 61984:
- 16A 500V 6kV 3**
- UL, CSA, CCC, GL certified
- for maximum current load, see the insert load curve section on page 30
- for contact crimping instructions, please see the crimping tool section (16A contacts, CCF, CCM and CC...AN series) on pages 296, 300, 304, 306, 308

inserts, crimp connections

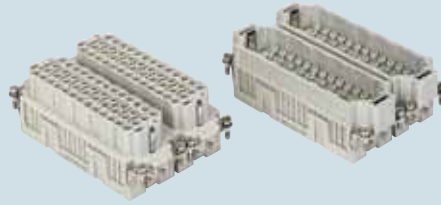

16A crimp contacts normal and for advanced opening silver and gold plated



description	part No.	part No.	part No.	part No.
without contacts (to be ordered separately) female inserts, No. (1÷46) and (47÷92) male inserts, No. (1÷46) and (47÷92)	CQEF 46 CQEM 46	CQEF 46 N CQEM 46 N		
16A female contacts 0.5 mm ² AWG 20 with no grooves 0.75 mm ² AWG 18 one groove (back side) 1 mm ² AWG 18 one groove 1.5 mm ² AWG 16 two grooves 2.5 mm ² AWG 14 three grooves 3 mm ² AWG 12 one wide groove 4 mm ² AWG 12 with no grooves			CCFA 0.5 CCFA 0.7 CCFA 1.0 CCFA 1.5 CCFA 2.5 CCFA 3.0 CCFA 4.0	CCFD 0.5 CCFD 0.7 CCFD 1.0 CCFD 1.5 CCFD 2.5 CCFD 3.0 CCFD 4.0
16A male contacts 0.5 mm ² AWG 20 with no grooves 0.75 mm ² AWG 18 one groove (back side) 1 mm ² AWG 18 one groove 1.5 mm ² AWG 16 two grooves 2.5 mm ² AWG 14 three grooves 3 mm ² AWG 12 one wide groove 4 mm ² AWG 12 with no grooves			CCMA 0.5 CCMA 0.7 CCMA 1.0 CCMA 1.5 CCMA 2.5 CCMA 3.0 CCMA 4.0	CCMD 0.5 CCMD 0.7 CCMD 1.0 CCMD 1.5 CCMD 2.5 CCMD 3.0 CCMD 4.0
16A male crimp contacts for advanced opening 0.5 mm ² AWG 20 with no grooves 0.75 mm ² AWG 18 one groove (back side) 1 mm ² AWG 18 one groove 1.5 mm ² AWG 16 two grooves 2.5 mm ² AWG 14 three grooves			CC 0.5 AN CC 0.7 AN CC 1.0 AN CC 1.5 AN CC 2.5 AN	

dimensions in mm

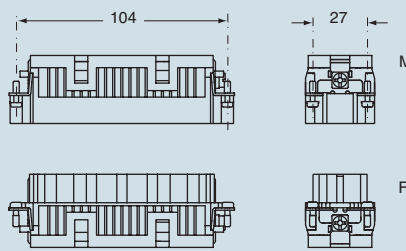

contacts side (front view)

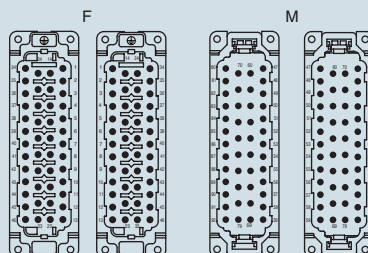

dimensions in mm

CCF and CCM CC...AN

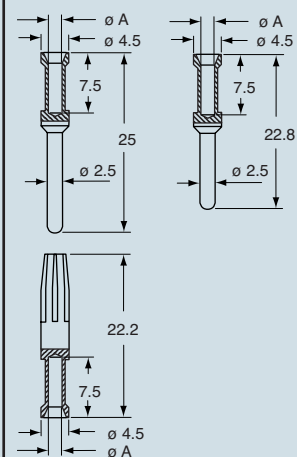

CCF, CCM and CC..AN contacts

conductor section mm ²	ø slot A (mm)
0.5	1.1
0.75	1.3
1.0	1.45
1.5	1.8
2.5	2.2
3	2.55
4	2.85

dimensions indicated are not binding and may be changed without notice

- stripping length see section feature of inserts on page 13

enclosures: **size "44.27"**

standard page: 176 ÷ 179
for 180 °Cpage: 180
aggressive environments page: 181
EMC page: 182

panel supports:
COB page: 258 ÷ 259

- features according to EN 61984:
16A 400V 4kV 2
- UL, CSA, CCC, GL certified
- for maximum current load, see the insert load curve section on page 31

**inserts,
screw terminal connections**



description

part No.

indirect, with plate 1)
female inserts with female contacts
male inserts with male contacts

**CNF 06
CNM 06**

indirect, with plate 1), use in up to 180 °C
female inserts with female contacts, brown
male inserts with male contacts, brown

**CNF 06 RY
CNM 06 RY**

1) for non-prepared conductors

dimensions in mm

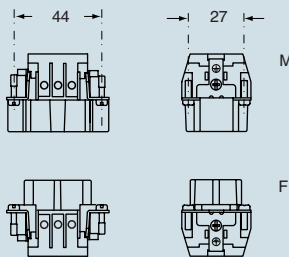

contacts side (front view)

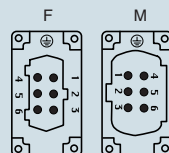

- inserts with plate, for section conductors:
0.75 ÷ 2.5 mm² - AWG 18 ÷ 14
- torsion couple recommended for conductor fastening screws and stripping length see section feature of inserts on page 13

dimensions indicated are not binding
and may be changed without notice

enclosures: **size "57.27"**

- standard** page: 184 ÷ 188
- for 180 °C** page: 194
- aggressive environments** page: 195
- EMC** page: 196

panel supports:
COB page: 258 ÷ 259

- features according to EN 61984:
16A 400V 4kV 2
- UL, CSA, CCC, GL certified
- for maximum current load, see the insert load curve section on page 31

**inserts,
 screw terminal connections**

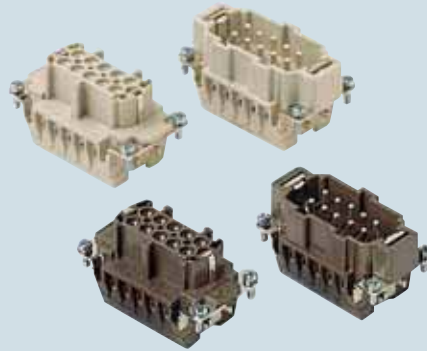

description	part No.
-------------	----------

indirect, with plate 1) female inserts with female contacts male inserts with male contacts	CNF 10 CNM 10
---	--------------------------------

indirect, with plate 1), use in up to 180 °C female inserts with female contacts, brown male inserts with male contacts, brown	CNF 10 RY CNM 10 RY
--	--------------------------------------

1) for non-prepared conductors



dimensions in mm

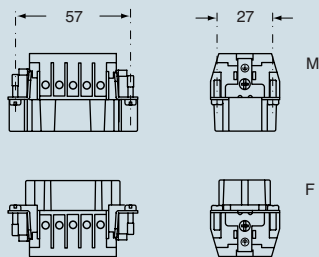

contacts side (front view)

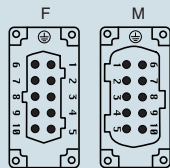

- inserts with plate, for section conductors:
 0.75 ÷ 2.5 mm² - AWG 18 ÷ 14
- torsion couple recommended for conductor fastening
 screws and stripping length see section feature of
 inserts on page 13

dimensions indicated are not binding
 and may be changed without notice

enclosures: **size "77.27"**

standard page: 198 ÷ 202
for 180 °C page: 208
aggressive environments page: 209
EMC page: 210

panel supports:

COB page: 258 ÷ 259

- features according to EN 61984:
16A 400V 4kV 2
- UL, CSA, CCC, GL certified
- for maximum current load, see the insert load curve section on page 31

**inserts,
screw terminal connections**

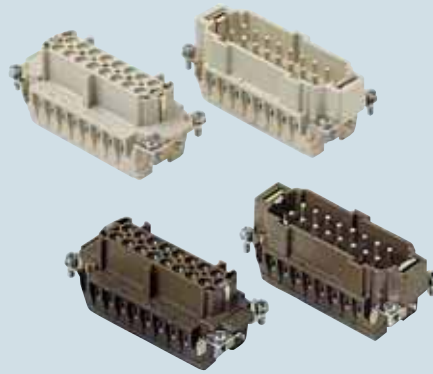

description

part No.

indirect, with plate 1)
 female inserts with female contacts
 male inserts with male contacts

CNF 16
CNM 16

indirect, with plate 1), use in up to 180 °C
 female inserts with female contacts, brown
 male inserts with male contacts, brown

CNF 16 RY
CNM 16 RY

1) for non-prepared conductors

dimensions in mm

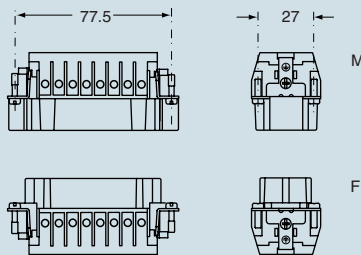

contacts side (front view)

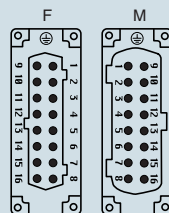

- inserts with plate, for section conductors:
 0.75 ÷ 2.5 mm² - AWG 18 ÷ 14
- torsion couple recommended for conductor fastening screws and stripping length see section feature of inserts on page 13

dimensions indicated are not binding
 and may be changed without notice

CN

enclosures: **size "104.27"**

- standard** page: 212 ÷ 216
- for 180 °C** page: 222
- aggressive environments** page: 223
- EMC** page: 224

panel supports:

COB page: 258 ÷ 259

- features according to EN 61984:
16A 400V 4kV 2
- UL, CSA, CCC, GL certified
- for maximum current load, see the insert load curve section on page 31

**inserts,
screw terminal connections**

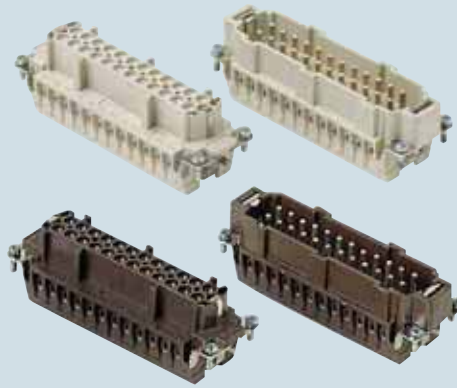

description	part No.
indirect, with plate 1) female inserts with female contacts male inserts with male contacts	CNF 24 CNM 24
indirect, with plate 1), use in up to 180 °C female inserts with female contacts, brown male inserts with male contacts, brown	CNF 24 RY CNM 24 RY
1) for non-prepared conductors	<p>dimensions in mm</p> <p>contacts side (front view)</p> <p>- inserts with plate, for section conductors: 0.75 ÷ 2.5 mm² - AWG 18 ÷ 14 - torsion couple recommended for conductor fastening screws and stripping length see section feature of inserts on page 13</p>

dimensions indicated are not binding and may be changed without notice

enclosures: size "77.62"

standard page: 226 ÷ 229

aggressive environments page: 230

- features according to EN 61984:
- 16A 400V 4kV 2**
- UL, CSA, CCC, GL certified
- for maximum current load, see the insert load curve section on page 31

inserts,
screw terminal connections



description	part No.	part No.
without contacts (to be ordered separately)		
female inserts, No. (1÷16) and (17÷32)	CCF 16	CCF 16 N
male inserts, No. (1÷16) and (17÷32)	CCM 16	CCM 16 N

1) for non-prepared conductors



dimensions in mm

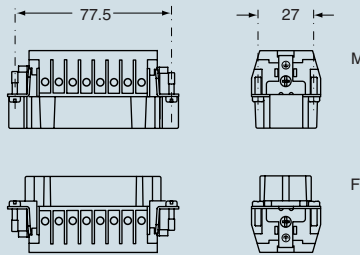

contacts side (front view)

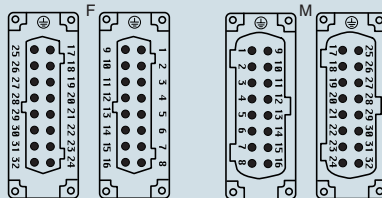

- inserts with plate, for section conductors:
0.75 ÷ 2.5 mm² - AWG 18 ÷ 14
- torsion couple recommended for conductor fastening screws and stripping length see section feature of inserts on page 13

dimensions indicated are not binding
and may be changed without notice

CN

enclosures: **size "104.62"**

standard page: 232
for 180 °C page: 233
aggressive environments page: 234

- features according to EN 61984:
16A 400V 4kV 2
- UL, CSA, CCC, GL certified
- for maximum current load, see the insert load curve section at page 31

**inserts,
screw terminal connections**

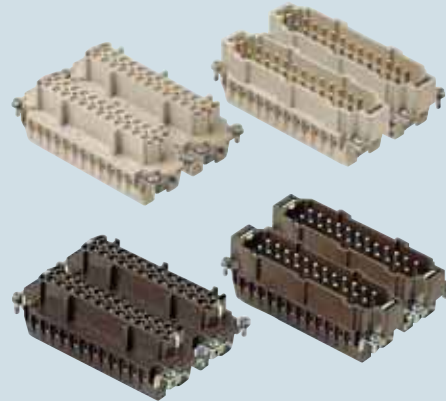

description	part No.	part No.
indirect, with plate 1) female inserts, No. (1÷24) and (25÷48) male inserts, No. (1÷24) and (25÷48)	CNF 24 CNM 24	CNF 24 N CNM 24 N
indirect, with plate 1), use in up to 180 °C female inserts, No. (1÷24) and (25÷48), brown male inserts, No. (1÷24) and (25÷48), brown	CNF 24 RY CNM 24 RY	CNF 24 RYN CNM 24 RYN

1) for non-prepared conductors



dimensions in mm

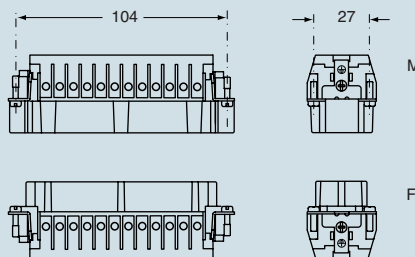

contacts side (front view)

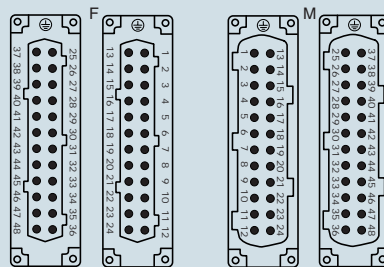

- inserts with plate, for section conductors:
0.75 ÷ 2.5 mm² - AWG 18 ÷ 14
- torsion couple recommended for conductor fastening screws and stripping length see section feature of inserts at page 13

dimensions indicated are not binding
and may be changed without notice

enclosures: **size "44.27"**

standard page: 176 ÷ 179
aggressive environments page: 181
EMC page: 182

panel supports:

COB page: 258 ÷ 259

- features according to EN 61984:

- 16A 500V 6kV 3**
- UL, CSA, CCC, GL certified
- for maximum current load, see the insert load curve section on page 31
- for contact crimping instructions, please see the crimping tool section (16A contacts, CCF, CCM and CC...AN series) on pages 296, 300, 304, 306, 308

inserts, crimp connections



16A crimp contacts normal and for advanced opening silver and gold plated



description	part No.	part No.	part No.
without contacts (to be ordered separately) female inserts for female contacts male inserts for male contacts	CCEF 06 CCEM 06		
16A female contacts 0.5 mm ² AWG 20 with no grooves 0.75 mm ² AWG 18 one groove (back side) 1 mm ² AWG 18 one groove 1.5 mm ² AWG 16 two grooves 2.5 mm ² AWG 14 three grooves 3 mm ² AWG 12 one wide groove 4 mm ² AWG 12 with no grooves		CCFA 0.5 CCFA 0.7 CCFA 1.0 CCFA 1.5 CCFA 2.5 CCFA 3.0 CCFA 4.0	CCFD 0.5 CCFD 0.7 CCFD 1.0 CCFD 1.5 CCFD 2.5 CCFD 3.0 CCFD 4.0
16A male contacts 0.5 mm ² AWG 20 with no grooves 0.75 mm ² AWG 18 one groove (back side) 1 mm ² AWG 18 one groove 1.5 mm ² AWG 16 two grooves 2.5 mm ² AWG 14 three grooves 3 mm ² AWG 12 one wide groove 4 mm ² AWG 12 with no grooves		CCMA 0.5 CCMA 0.7 CCMA 1.0 CCMA 1.5 CCMA 2.5 CCMA 3.0 CCMA 4.0	CCMD 0.5 CCMD 0.7 CCMD 1.0 CCMD 1.5 CCMD 2.5 CCMD 3.0 CCMD 4.0
16A male crimp contacts for advanced opening 0.5 mm ² AWG 20 with no grooves 0.75 mm ² AWG 18 one groove (back side) 1 mm ² AWG 18 one groove 1.5 mm ² AWG 16 two grooves 2.5 mm ² AWG 14 three grooves		CC 0.5 AN CC 0.7 AN CC 1.0 AN CC 1.5 AN CC 2.5 AN	

silver plated

gold plated

dimensions in mm

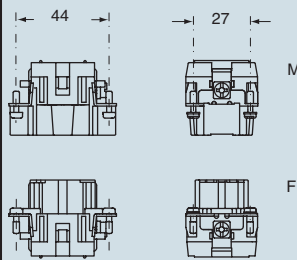

contacts side (front view)

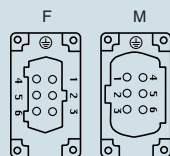

dimensions in mm

CCF and CCM

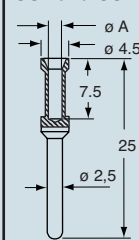

CC...AN

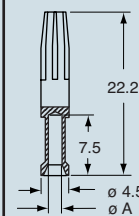
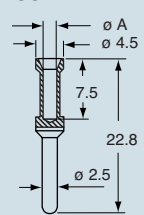

CCF, CCM and CC..AN contacts

conductor section mm ²	ø slot A (mm)
0.5	1.1
0.75	1.3
1.0	1.45
1.5	1.8
2.5	2.2
3	2.55
4	2.85

dimensions indicated are not binding and may be changed without notice

- stripping length see section feature of inserts on page 13

CNE - CSE 6 poles + ⊕ 16A - 500V



enclosures: **size "44.27"**

- standard** page: 176 ÷ 179
- for 180 °C** page: 180
- aggressive environments** page: 181
- EMC** page: 182

panel supports:
COB page: 258 ÷ 259

- features according to EN 61984:
- 16A 500V 6kV 3**
- UL, CSA, CCC, GL certified
- for maximum current load, see the insert load curve section on page 31

inserts, screw terminal connections

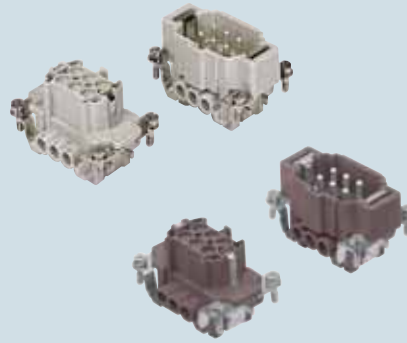

inserts, spring terminal connections

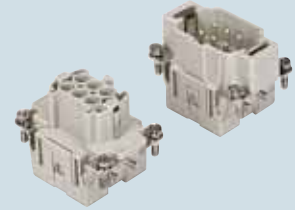

description	part No.	part No.
indirect, with plate 1) female inserts with female contacts male inserts with male contacts	CNEF 06 T CNEM 06 T	
direct, without plate 2) female inserts with female contacts male inserts with male contacts	CNEF 06 TX CNEM 06 TX	
indirect, with plate 1), use in up to 180 °C female inserts with female contacts, brown male inserts with male contacts, brown	CNEF 06 RYT * CNEM 06 RYT *	
spring terminal female inserts with female contacts male inserts with male contacts		CSEF 06 CSEM 06

- 1) for non-prepared conductors
- 2) for bush terminal conductors

* CNE...RYT version without plastic wire insertion guide cover available on request.

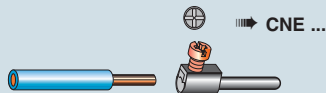

connection with spring terminal

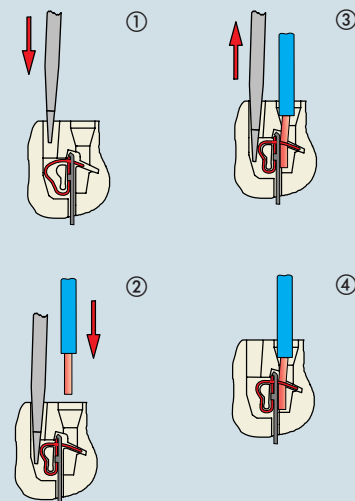

dimensions indicated are not binding and may be changed without notice

dimensions in mm

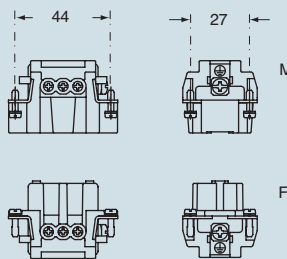

contacts side (front view)

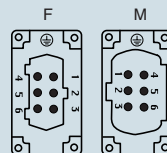

- inserts with plate, for section conductors: 0.75 ÷ 2.5 mm² - AWG 18 ÷ 14
- inserts without plate, for section conductors: 0.25 ÷ 2.5 mm² - AWG 24 ÷ 14
- torsion couple recommended for conductor fastening screws and stripping length see section feature of inserts on page 13

dimensions in mm

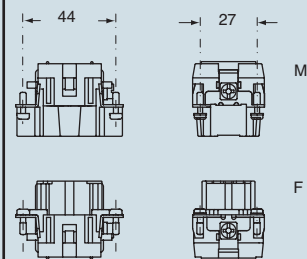

contacts side (front view)

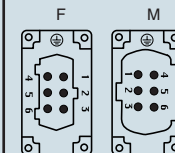

- inserts for section conductors: 0.14 ÷ 2.5 mm² - AWG 26 ÷ 14
- stripping length see section feature of inserts on page 13

enclosures: **size "57.27"**

standard page: 184 ÷ 188
aggressive environments page: 195
EMC page: 196

panel supports:

COB page: 258 ÷ 259

- features according to EN 61984:

- 16A 500V 6kV 3**
- UL, CSA, CCC, GL certified
- for maximum current load, see the insert load curve section on page 31
- for contact crimping instructions, please see the crimping tool section (16A contacts, CCF, CCM and CC...AN series) on pages 296, 300, 304, 306, 308

inserts, crimp connections

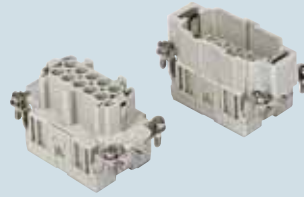

16A crimp contacts normal and for advanced opening silver and gold plated



description	part No.	part No.	part No.
without contacts (to be ordered separately) female inserts for female contacts male inserts for male contacts	CCEF 10 CCEM 10		
16A female contacts 0.5 mm ² AWG 20 with no grooves 0.75 mm ² AWG 18 one groove (back side) 1 mm ² AWG 18 one groove 1.5 mm ² AWG 16 two grooves 2.5 mm ² AWG 14 three grooves 3 mm ² AWG 12 one wide groove 4 mm ² AWG 12 with no grooves		CCFA 0.5 CCFA 0.7 CCFA 1.0 CCFA 1.5 CCFA 2.5 CCFA 3.0 CCFA 4.0	CCFD 0.5 CCFD 0.7 CCFD 1.0 CCFD 1.5 CCFD 2.5 CCFD 3.0 CCFD 4.0
16A male contacts 0.5 mm ² AWG 20 with no grooves 0.75 mm ² AWG 18 one groove (back side) 1 mm ² AWG 18 one groove 1.5 mm ² AWG 16 two grooves 2.5 mm ² AWG 14 three grooves 3 mm ² AWG 12 one wide groove 4 mm ² AWG 12 with no grooves		CCMA 0.5 CCMA 0.7 CCMA 1.0 CCMA 1.5 CCMA 2.5 CCMA 3.0 CCMA 4.0	CCMD 0.5 CCMD 0.7 CCMD 1.0 CCMD 1.5 CCMD 2.5 CCMD 3.0 CCMD 4.0
16A male crimp contacts for advanced opening 0.5 mm ² AWG 20 with no grooves 0.75 mm ² AWG 18 one groove (back side) 1 mm ² AWG 18 one groove 1.5 mm ² AWG 16 two grooves 2.5 mm ² AWG 14 three grooves		CC 0.5 AN CC 0.7 AN CC 1.0 AN CC 1.5 AN CC 2.5 AN	

silver plated

gold plated

dimensions in mm

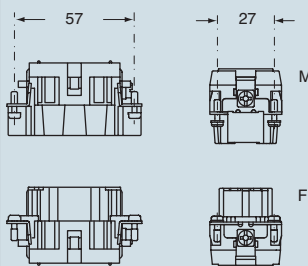

contacts side (front view)

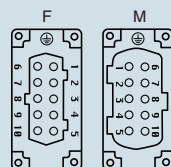

dimensions in mm

CCF and CCM

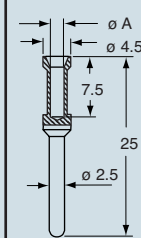

CC...AN

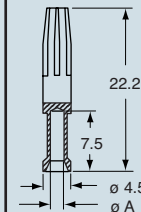
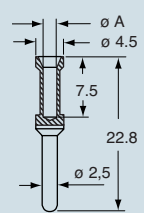

CCF, CCM and CC..AN contacts

conductor section mm ²	ø slot A (mm)
0.5	1.1
0.75	1.3
1.0	1.45
1.5	1.8
2.5	2.2
3	2.55
4	2.85

dimensions indicated are not binding and may be changed without notice

- stripping length see section feature of inserts on page 13

CNE - CSE 10 poles + ⊕ 16A - 500V



enclosures: **size "57.27"**

- standard** page: 184 ÷ 188
- for 180 °C** page: 194
- aggressive environments** page: 195
- EMC** page: 196

panel supports:
COB page: 258 ÷ 259

- features according to EN 61984:
- 16A 500V 6kV 3**
- UL, CSA, CCC, GL certified
- for maximum current load, see the insert load curve section on page 31

inserts, screw terminal connections

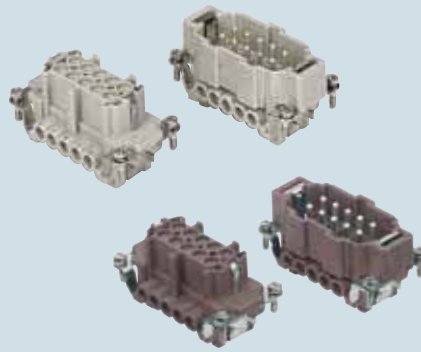

inserts, spring terminal connections

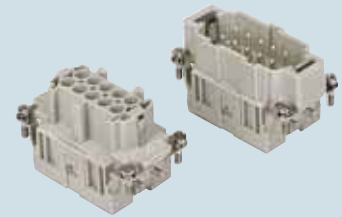

description	part No.	part No.
indirect, with plate 1) female inserts with female contacts male inserts with male contacts	CNEF 10 T CNEM 10 T	
direct, without plate 2) female inserts with female contacts male inserts with male contacts	CNEF 10 TX CNEM 10 TX	
indirect, with plate 1), use in up to 180 °C female inserts with female contacts, brown male inserts with male contacts, brown	CNEF 10 RYT * CNEM 10 RYT *	
spring terminal female inserts with female contacts male inserts with male contacts		CSEF 10 CSEM 10

- 1) for non-prepared conductors
- 2) for bush terminal conductors

* CNE...RYT version without plastic wire insertion guide cover available on request.

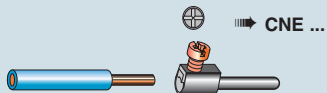

connection with spring terminal

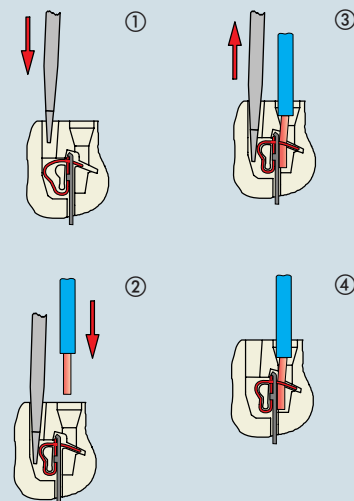

dimensions indicated are not binding and may be changed without notice

dimensions in mm

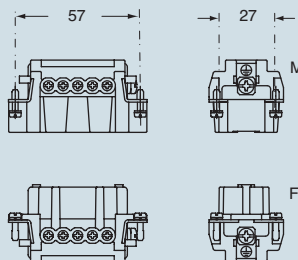

contacts side (front view)

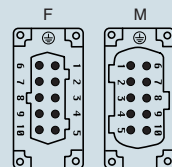

- inserts with plate, for section conductors: 0.75 ÷ 2.5 mm² - AWG 18 ÷ 14
- inserts without plate, for section conductors: 0.25 ÷ 2.5 mm² - AWG 24 ÷ 14
- torsion couple recommended for conductor fastening screws and stripping length see section feature of inserts on page 13

dimensions in mm

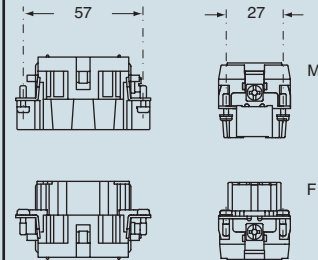

contacts side (front view)

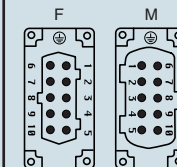

- inserts for section conductors: 0.14 ÷ 2.5 mm² - AWG 26 ÷ 14
- stripping length see section feature of inserts on page 13

enclosures: **size "77.27"**

standard page: 198 ÷ 202
aggressive environments page: 209
EMC page: 210

panel supports:

COB page: 258 ÷ 259

- features according to EN 61984:

- 16A 500V 6kV 3**
- UL, CSA, CCC, GL certified
- for maximum current load, see the insert load curve section on page 31
- for contact crimping instructions, please see the crimping tool section (16A contacts, CCF, CCM and CC...AN series) on pages 296, 300, 304, 306, 308

inserts, crimp connections

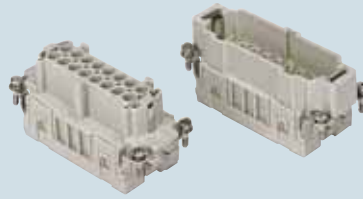

16A crimp contacts normal and for advanced opening silver and gold plated



description	part No.	part No.	part No.
without contacts (to be ordered separately) female inserts for female contacts male inserts for male contacts	CCEF 16 CCEM 16		
16A female contacts 0.5 mm ² AWG 20 with no grooves 0.75 mm ² AWG 18 one groove (back side) 1 mm ² AWG 18 one groove 1.5 mm ² AWG 16 two grooves 2.5 mm ² AWG 14 three grooves 3 mm ² AWG 12 one wide groove 4 mm ² AWG 12 with no grooves		CCFA 0.5 CCFA 0.7 CCFA 1.0 CCFA 1.5 CCFA 2.5 CCFA 3.0 CCFA 4.0	CCFD 0.5 CCFD 0.7 CCFD 1.0 CCFD 1.5 CCFD 2.5 CCFD 3.0 CCFD 4.0
16A male contacts 0.5 mm ² AWG 20 with no grooves 0.75 mm ² AWG 18 one groove (back side) 1 mm ² AWG 18 one groove 1.5 mm ² AWG 16 two grooves 2.5 mm ² AWG 14 three grooves 3 mm ² AWG 12 one wide groove 4 mm ² AWG 12 with no grooves		CCMA 0.5 CCMA 0.7 CCMA 1.0 CCMA 1.5 CCMA 2.5 CCMA 3.0 CCMA 4.0	CCMD 0.5 CCMD 0.7 CCMD 1.0 CCMD 1.5 CCMD 2.5 CCMD 3.0 CCMD 4.0
16A male crimp contacts for advanced opening 0.5 mm ² AWG 20 with no grooves 0.75 mm ² AWG 18 one groove (back side) 1 mm ² AWG 18 one groove 1.5 mm ² AWG 16 two grooves 2.5 mm ² AWG 14 three grooves		CC 0.5 AN CC 0.7 AN CC 1.0 AN CC 1.5 AN CC 2.5 AN	

silver plated

gold plated

dimensions in mm

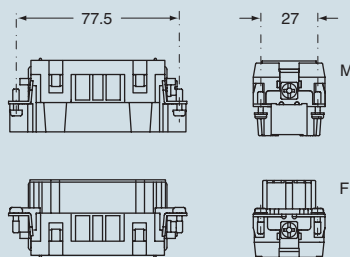

contacts side (front view)

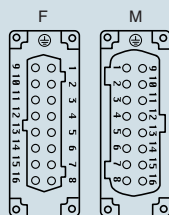

dimensions in mm

CCF and CCM

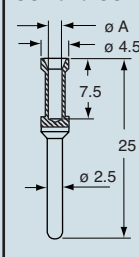

CC...AN

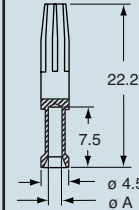
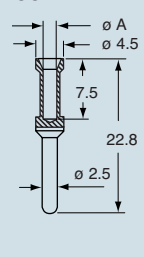

CCF, CCM and CC..AN contacts

conductor section mm ²	ø slot A (mm)
0.5	1.1
0.75	1.3
1.0	1.45
1.5	1.8
2.5	2.2
3	2.55
4	2.85

dimensions indicated are not binding and may be changed without notice

- stripping length see section feature of inserts on page 13

CCE

CNE - CSE 16 poles + ⊕ 16A - 500V



enclosures: **size "77.27"**

- standard** page: 198 ÷ 202
- for 180 °C** page: 208
- aggressive environments** page: 209
- EMC** page: 210

panel supports:
COB page: 258 ÷ 259

- features according to EN 61984:
- 16A 500V 6kV 3**
- UL, CSA, CCC, GL certified
- for maximum current load, see the insert load curve section on page 31

inserts, screw terminal connections

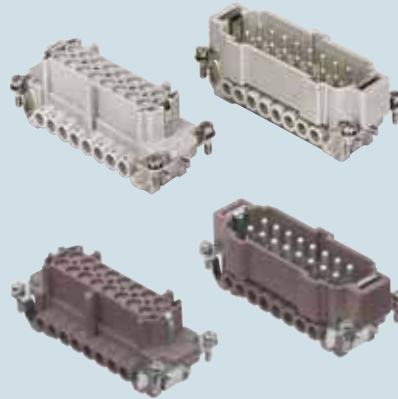

inserts, spring terminal connections

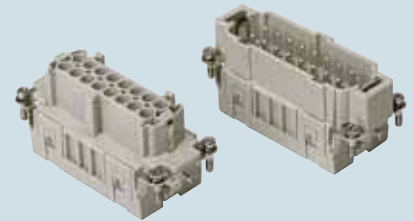

description	part No.	part No.
indirect, with plate 1) female inserts with female contacts male inserts with male contacts	CNEF 16 T CNEM 16 T	
direct, without plate 2) female inserts with female contacts male inserts with male contacts	CNEF 16 TX CNEM 16 TX	
indirect, with plate 1), use in up to 180 °C female inserts with female contacts, brown male inserts with male contacts, brown	CNEF 16 RYT * CNEM 16 RYT *	
spring terminal female inserts with female contacts male inserts with male contacts		CSF 16 CSM 16

- 1) for non-prepared conductors
- 2) for bush terminal conductors

* CNE...RY version without plastic wire insertion guide cover available on request.

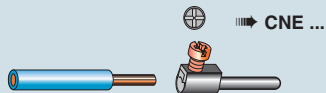

connection with spring terminal

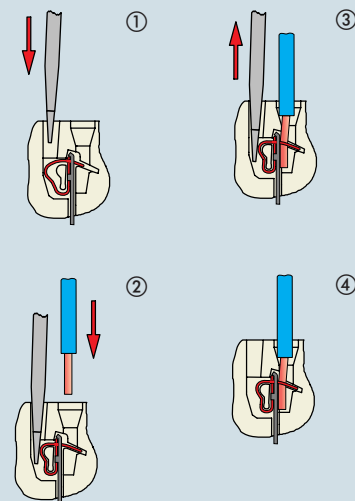

dimensions indicated are not binding and may be changed without notice

dimensions in mm

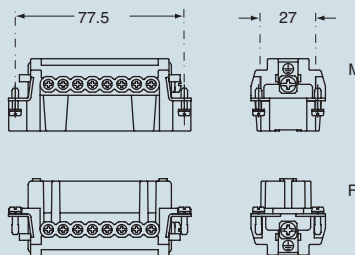

contacts side (front view)

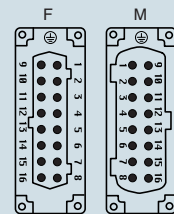

- inserts with plate, for section conductors: 0.75 ÷ 2.5 mm² - AWG 18 ÷ 14
- inserts without plate, for section conductors: 0.25 ÷ 2.5 mm² - AWG 24 ÷ 14
- torsion couple recommended for conductor fastening screws and stripping length see section feature of inserts on page 13

dimensions in mm

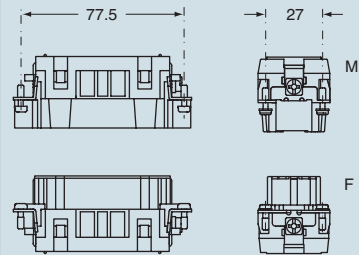

contacts side (front view)

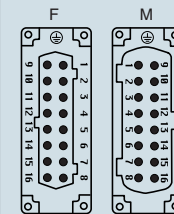

- inserts for section conductors: 0.14 ÷ 2.5 mm² - AWG 26 ÷ 14
- stripping length see section feature of inserts on page 13

enclosures: size "104.27"

standard page: 212 ÷ 216
 aggressive environments page: 223
 EMC page: 224

panel supports:
 COB page: 258 ÷ 259

- features according to EN 61984:
- 16A 500V 6kV 3**
- UL, CSA, CCC, GL certified
- for maximum current load, see the insert load curve section on page 31
- for contact crimping instructions, please see the crimping tool section (16A contacts, CCF, CCM and CC...AN series) on pages 296, 300, 304, 306, 308

inserts, crimp connections

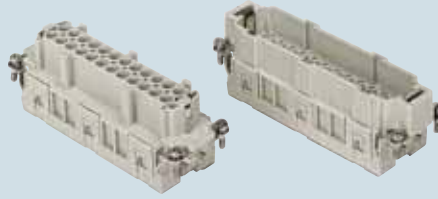

16A crimp contacts normal and for advanced opening silver and gold plated



description	part No.	part No.	part No.
without contacts (to be ordered separately) female inserts for female contacts male inserts for male contacts	CCEF 24 CCEM 24		
16A female contacts 0.5 mm ² AWG 20 with no grooves 0.75 mm ² AWG 18 one groove (back side) 1 mm ² AWG 18 one groove 1.5 mm ² AWG 16 two grooves 2.5 mm ² AWG 14 three grooves 3 mm ² AWG 12 one wide groove 4 mm ² AWG 12 with no grooves 16A male contacts 0.5 mm ² AWG 20 with no grooves 0.75 mm ² AWG 18 one groove (back side) 1 mm ² AWG 18 one groove 1.5 mm ² AWG 16 two grooves 2.5 mm ² AWG 14 three grooves 3 mm ² AWG 12 one wide groove 4 mm ² AWG 12 with no grooves		CCFA 0.5 CCFA 0.7 CCFA 1.0 CCFA 1.5 CCFA 2.5 CCFA 3.0 CCFA 4.0 CCMA 0.5 CCMA 0.7 CCMA 1.0 CCMA 1.5 CCMA 2.5 CCMA 3.0 CCMA 4.0	CCFD 0.5 CCFD 0.7 CCFD 1.0 CCFD 1.5 CCFD 2.5 CCFD 3.0 CCFD 4.0 CCMD 0.5 CCMD 0.7 CCMD 1.0 CCMD 1.5 CCMD 2.5 CCMD 3.0 CCMD 4.0
16A male crimp contacts for advanced opening 0.5 mm ² AWG 20 with no grooves 0.75 mm ² AWG 18 one groove (back side) 1 mm ² AWG 18 one groove 1.5 mm ² AWG 16 two grooves 2.5 mm ² AWG 14 three grooves		CC 0.5 AN CC 0.7 AN CC 1.0 AN CC 1.5 AN CC 2.5 AN	

silver plated

gold plated

dimensions in mm

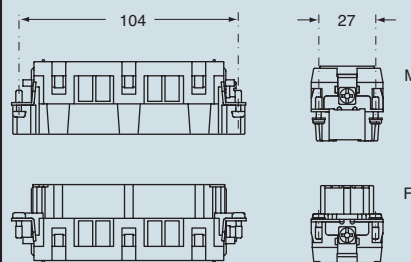

contacts side (front view)

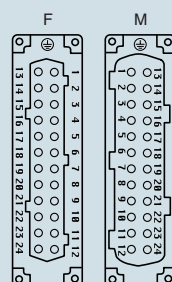

dimensions in mm

CCF and CCM

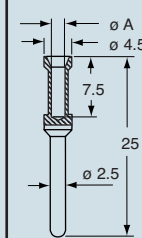

CC...AN

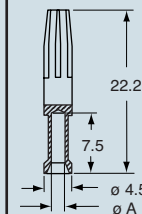
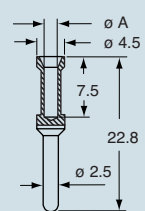

CCF, CCM and CC..AN contacts

conductor section mm ²	ø slot A (mm)
0.5	1.1
0.75	1.3
1.0	1.45
1.5	1.8
2.5	2.2
3	2.55
4	2.85

dimensions indicated are not binding and may be changed without notice

- stripping length see section feature of inserts on page 13

CNE - CSE 24 poles + ⊕ 16A - 500V



enclosures: **size "104.27"**

- standard** page: 212 ÷ 216
- for 180 °C** page: 222
- aggressive environments** page: 223
- EMC** page: 224

panel supports:

COB page: 258 ÷ 259

- features according to EN 61984:

- 16A 500V 6kV 3**
- UL, CSA, CCC, GL certified
- for maximum current load, see the insert load curve section on page 31

inserts, screw terminal connections

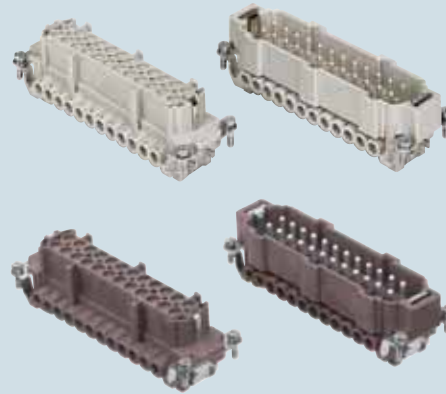

inserts, spring terminal connections

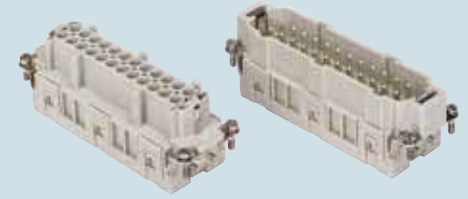

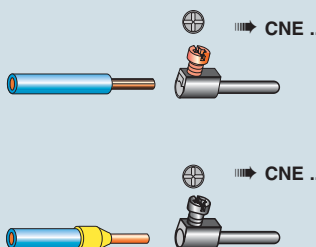
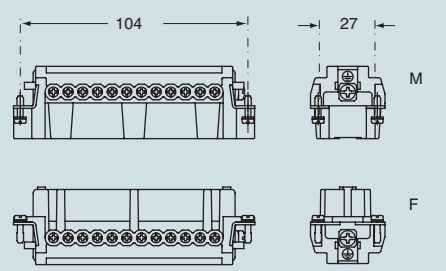
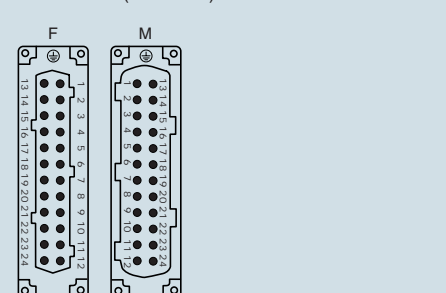
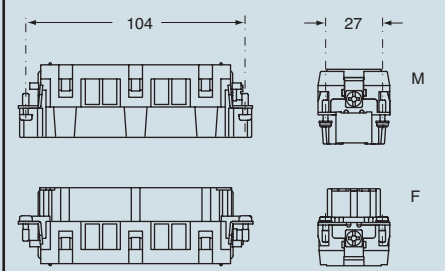
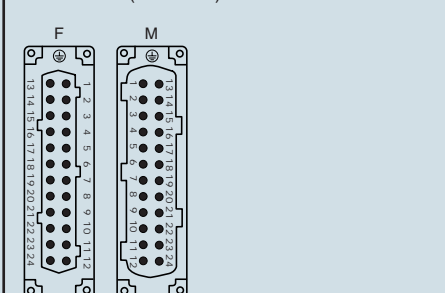
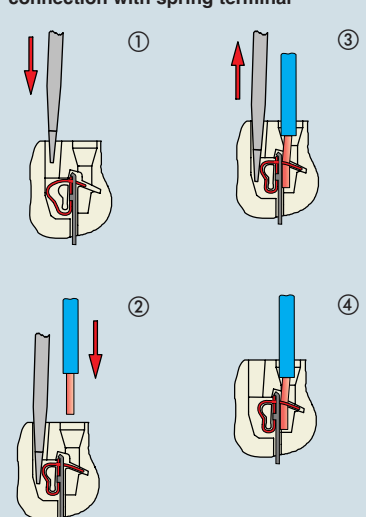
description	part No.	part No.
indirect, with plate 1) female inserts with female contacts male inserts with male contacts	CNEF 24 T CNEM 24 T	
direct, without plate 2) female inserts with female contacts male inserts with male contacts	CNEF 24 TX CNEM 24 TX	
indirect, with plate 1), use in temperatures up to 180 °C female inserts with female contacts, brown male inserts with male contacts, brown	CNEF 24 RYT * CNEM 24 RYT *	
spring terminal female inserts with female contacts male inserts with male contacts		CSEF 24 CSEM 24
1) for non-prepared conductors 2) for bush terminal conductors	dimensions in mm	dimensions in mm
<p>* CNE...RY version without plastic wire insertion guide cover available on request.</p> 	 <p>contacts side (front view)</p> 	 <p>contacts side (front view)</p> 
<p>connection with spring terminal</p>  <p>dimensions indicated are not binding and may be changed without notice</p>	<ul style="list-style-type: none"> - inserts with plate, for section conductors: 0.5 ÷ 2.5 mm² - AWG 20 ÷ 14 - inserts without plate, for section conductors: 0.25 ÷ 2.5 mm² - AWG 24 ÷ 14 - torsion couple recommended for conductor fastening screws and stripping length see section feature of inserts on page 13 	<ul style="list-style-type: none"> - inserts for section conductors: 0.14 ÷ 2.5 mm² - AWG 26 ÷ 14 - stripping length see section feature of inserts on page 13

CNE - CSE

enclosures: size "77.62"

standard page: 226 ÷ 229

aggressive environments page: 230

- features according to EN 61984:

- 16A 500V 6kV 3**
- UL, CSA, CCC, GL certified
- for maximum current load, see the insert load curve section on page 31
- for contact crimping instructions, please see the crimping tool section (16A contacts, CCF, CCM and CC...AN series) on pages 296, 300, 304, 306, 308

inserts, crimp connections

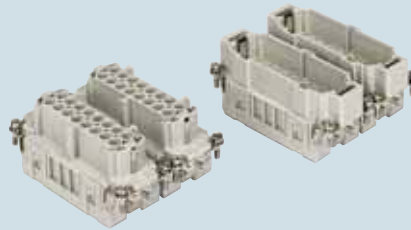

16A crimp contacts normal and for advanced opening silver and gold plated



description	part No.	part No.	part No.	part No.
without contacts (to be ordered separately) female inserts, No. (1÷16) and (17÷32) male inserts, No. (1÷16) and (17÷32)	CCEF 16 CCEM 16	CCEF 16 N CCEM 16 N		
16A female contacts 0.5 mm ² AWG 20 with no grooves 0.75 mm ² AWG 18 one groove (back side) 1 mm ² AWG 18 one groove 1.5 mm ² AWG 16 two grooves 2.5 mm ² AWG 14 three grooves 3 mm ² AWG 12 one wide groove 4 mm ² AWG 12 with no grooves 16A male contacts 0.5 mm ² AWG 20 with no grooves 0.75 mm ² AWG 18 one groove (back side) 1 mm ² AWG 18 one groove 1.5 mm ² AWG 16 two grooves 2.5 mm ² AWG 14 three grooves 3 mm ² AWG 12 one wide groove 4 mm ² AWG 12 with no grooves			CCFA 0.5 CCFA 0.7 CCFA 1.0 CCFA 1.5 CCFA 2.5 CCFA 3.0 CCFA 4.0 CCMA 0.5 CCMA 0.7 CCMA 1.0 CCMA 1.5 CCMA 2.5 CCMA 3.0 CCMA 4.0	CCFD 0.5 CCFD 0.7 CCFD 1.0 CCFD 1.5 CCFD 2.5 CCFD 3.0 CCFD 4.0 CCMD 0.5 CCMD 0.7 CCMD 1.0 CCMD 1.5 CCMD 2.5 CCMD 3.0 CCMD 4.0
16A male crimp contacts for advanced opening 0.5 mm ² AWG 20 with no grooves 0.75 mm ² AWG 18 one groove (back side) 1 mm ² AWG 18 one groove 1.5 mm ² AWG 16 two grooves 2.5 mm ² AWG 14 three grooves			CC 0.5 AN CC 0.7 AN CC 1.0 AN CC 1.5 AN CC 2.5 AN	

dimensions in mm

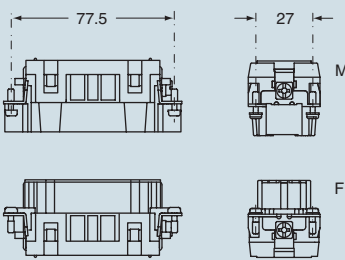

contacts side (front view)

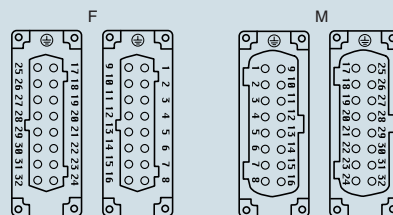

dimensions in mm

CCF and CCM

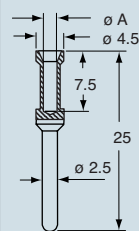

CC...AN

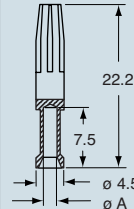
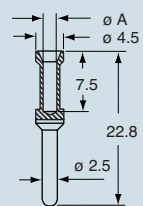

CCF, CCM and CC..AN contacts

conductor section mm ²	ø slot A (mm)
0.5	1.1
0.75	1.3
1.0	1.45
1.5	1.8
2.5	2.2
3	2.55
4	2.85

dimensions indicated are not binding and may be changed without notice

- stripping length see section feature of inserts on page 13

CCE

enclosures: size "77.62"

standard page: 226 ÷ 229

aggressive environments page: 230

- features according to EN 61984:
- 16A 500V 6kV 3**
- UL, CSA, CCC, GL certified
- for maximum current load, see the insert load curve section on page 31

inserts,
screw terminal connections

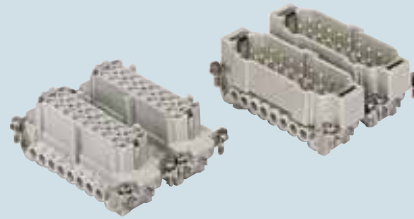

inserts,
spring terminal connections

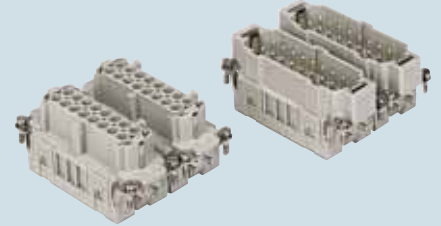

description	part No.	part No.	part No.	part No.
indirect, with plate 1) female inserts, No. (1÷16) and (17÷32) male inserts, No. (1÷16) and (17÷32)	CNEF 16 T CNEM 16 T	CNEF 16 TN CNEM 16 TN		
direct, without plate 2) female inserts, No. (1÷16) and (17÷32) male inserts, No. (1÷16) and (17÷32)	CNEF 16 TX CNEM 16 TX	CNEF 16 TXN CNEM 16 TXN		
spring terminal female inserts, No. (1÷16) and (17÷32) male inserts, No. (1÷16) and (17÷32)			CSEF 16 CSEM 16	CSEF 16 N CSEM 16 N

- 1) for non-prepared conductors
- 2) for bush terminal conductors

* CNE...RY version without plastic wire insertion guide cover available on request.

CNE ...

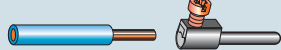

CNE ... X

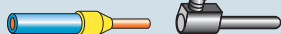

connection with spring terminal

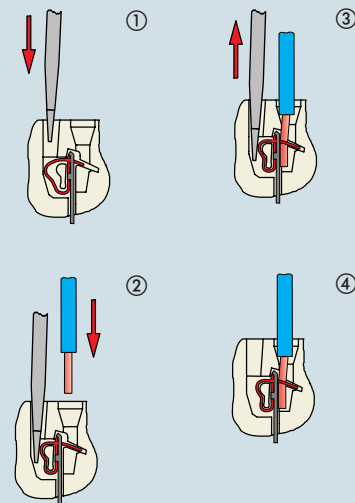

dimensions in mm

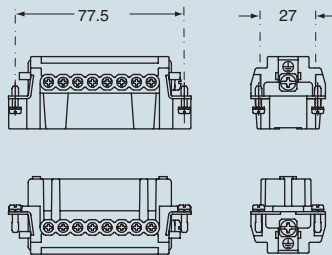

contacts side (front view)

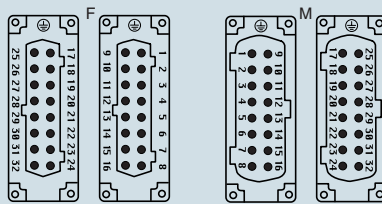

- inserts with plate, for section conductors:
0.5 ÷ 2.5 mm² - AWG 20 ÷ 14
- inserts without plate, for section conductors:
0.25 ÷ 2.5 mm² - AWG 24 ÷ 14
- torsion couple recommended for conductor fastening screws and stripping length see section feature of inserts on page 13

dimensions in mm

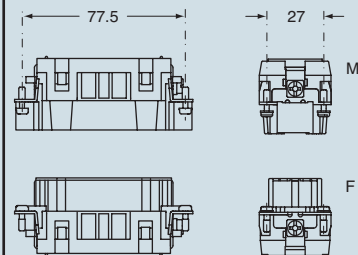

contacts side (front view)

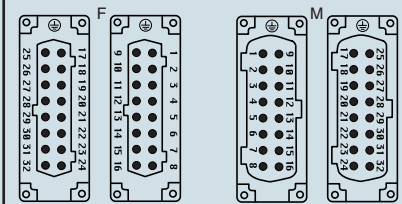

- inserts for section conductors:
0.14 ÷ 2.5 mm² - AWG 26 ÷ 14
- stripping length see section feature of inserts on page 13

dimensions indicated are not binding and may be changed without notice

enclosures: size "104.62"

standard page: 232

aggressive environments page: 234

- features according to EN 61984:
- 16A 500V 6kV 3**
- UL, CSA, CCC, GL certified
- for maximum current load, see the insert load curve section on page 31
- for contact crimping instructions, please see the crimping tool section (16A contacts, CCF, CCM and CC...AN series) on pages 296, 300, 304, 306, 308

inserts, crimp connections

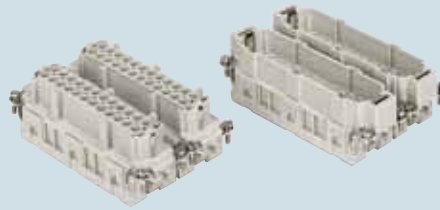

16A crimp contacts normal and for advanced opening silver and gold plated



description	part No.	part No.	part No.	part No.																																										
without contacts (to be ordered separately) female inserts, No. (1÷24) and (25÷48) male inserts, No. (1÷24) and (25÷48)	CCEF 24 CCEM 24	CCEF 24 N CCEM 24 N																																												
<p>16A female contacts</p> <table border="0"> <tr><td>0.5 mm²</td><td>AWG 20</td><td>with no grooves</td></tr> <tr><td>0.75 mm²</td><td>AWG 18</td><td>one groove (back side)</td></tr> <tr><td>1 mm²</td><td>AWG 18</td><td>one groove</td></tr> <tr><td>1.5 mm²</td><td>AWG 16</td><td>two grooves</td></tr> <tr><td>2.5 mm²</td><td>AWG 14</td><td>three grooves</td></tr> <tr><td>3 mm²</td><td>AWG 12</td><td>one wide groove</td></tr> <tr><td>4 mm²</td><td>AWG 12</td><td>with no grooves</td></tr> </table> <p>16A male contacts</p> <table border="0"> <tr><td>0.5 mm²</td><td>AWG 20</td><td>with no grooves</td></tr> <tr><td>0.75 mm²</td><td>AWG 18</td><td>one groove (back side)</td></tr> <tr><td>1 mm²</td><td>AWG 18</td><td>one groove</td></tr> <tr><td>1.5 mm²</td><td>AWG 16</td><td>two grooves</td></tr> <tr><td>2.5 mm²</td><td>AWG 14</td><td>three grooves</td></tr> <tr><td>3 mm²</td><td>AWG 12</td><td>one wide groove</td></tr> <tr><td>4 mm²</td><td>AWG 12</td><td>with no grooves</td></tr> </table>	0.5 mm ²	AWG 20	with no grooves	0.75 mm ²	AWG 18	one groove (back side)	1 mm ²	AWG 18	one groove	1.5 mm ²	AWG 16	two grooves	2.5 mm ²	AWG 14	three grooves	3 mm ²	AWG 12	one wide groove	4 mm ²	AWG 12	with no grooves	0.5 mm ²	AWG 20	with no grooves	0.75 mm ²	AWG 18	one groove (back side)	1 mm ²	AWG 18	one groove	1.5 mm ²	AWG 16	two grooves	2.5 mm ²	AWG 14	three grooves	3 mm ²	AWG 12	one wide groove	4 mm ²	AWG 12	with no grooves			<p>CCFA 0.5 CCFA 0.7 CCFA 1.0 CCFA 1.5 CCFA 2.5 CCFA 3.0 CCFA 4.0</p> <p style="writing-mode: vertical-rl; transform: rotate(180deg);">silver plated</p> <p>CCFD 0.5 CCFD 0.7 CCFD 1.0 CCFD 1.5 CCFD 2.5 CCFD 3.0 CCFD 4.0</p> <p style="writing-mode: vertical-rl; transform: rotate(180deg);">gold plated</p> <p>CCMA 0.5 CCMA 0.7 CCMA 1.0 CCMA 1.5 CCMA 2.5 CCMA 3.0 CCMA 4.0</p> <p>CCMD 0.5 CCMD 0.7 CCMD 1.0 CCMD 1.5 CCMD 2.5 CCMD 3.0 CCMD 4.0</p>	
0.5 mm ²	AWG 20	with no grooves																																												
0.75 mm ²	AWG 18	one groove (back side)																																												
1 mm ²	AWG 18	one groove																																												
1.5 mm ²	AWG 16	two grooves																																												
2.5 mm ²	AWG 14	three grooves																																												
3 mm ²	AWG 12	one wide groove																																												
4 mm ²	AWG 12	with no grooves																																												
0.5 mm ²	AWG 20	with no grooves																																												
0.75 mm ²	AWG 18	one groove (back side)																																												
1 mm ²	AWG 18	one groove																																												
1.5 mm ²	AWG 16	two grooves																																												
2.5 mm ²	AWG 14	three grooves																																												
3 mm ²	AWG 12	one wide groove																																												
4 mm ²	AWG 12	with no grooves																																												
<p>16A male crimp contacts for advanced opening</p> <table border="0"> <tr><td>0.5 mm²</td><td>AWG 20</td><td>with no grooves</td></tr> <tr><td>0.75 mm²</td><td>AWG 18</td><td>one groove (back side)</td></tr> <tr><td>1 mm²</td><td>AWG 18</td><td>one groove</td></tr> <tr><td>1.5 mm²</td><td>AWG 16</td><td>two grooves</td></tr> <tr><td>2.5 mm²</td><td>AWG 14</td><td>three grooves</td></tr> </table>	0.5 mm ²	AWG 20	with no grooves	0.75 mm ²	AWG 18	one groove (back side)	1 mm ²	AWG 18	one groove	1.5 mm ²	AWG 16	two grooves	2.5 mm ²	AWG 14	three grooves			<p>CC 0.5 AN CC 0.7 AN CC 1.0 AN CC 1.5 AN CC 2.5 AN</p>																												
0.5 mm ²	AWG 20	with no grooves																																												
0.75 mm ²	AWG 18	one groove (back side)																																												
1 mm ²	AWG 18	one groove																																												
1.5 mm ²	AWG 16	two grooves																																												
2.5 mm ²	AWG 14	three grooves																																												

dimensions in mm

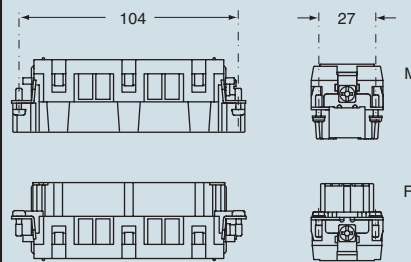

contacts side (front view)

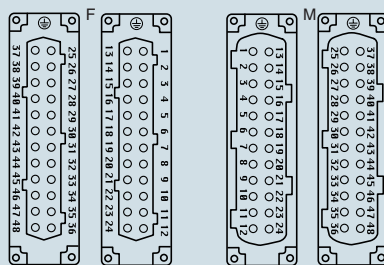

dimensions in mm

CCF and CCM

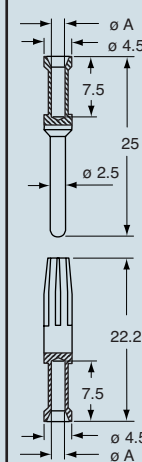

CC...AN

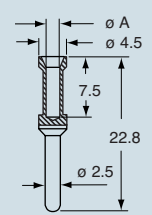

CCF, CCM and CC..AN contacts

conductor section mm ²	ø slot A (mm)
0.5	1.1
0.75	1.3
1.0	1.45
1.5	1.8
2.5	2.2
3	2.55
4	2.85

dimensions indicated are not binding and may be changed without notice

- stripping length see section feature of inserts on page 13

CCE

enclosures: size "104.62"

standard page: 232
 for 180 °C page: 233
 aggressive environments page: 234

- features according to EN 61984:
- 16A 500V 6kV 3**
- UL, CSA, CCC, GL certified
- for maximum current load, see the insert load curve section on page 31

**inserts,
screw terminal connections**

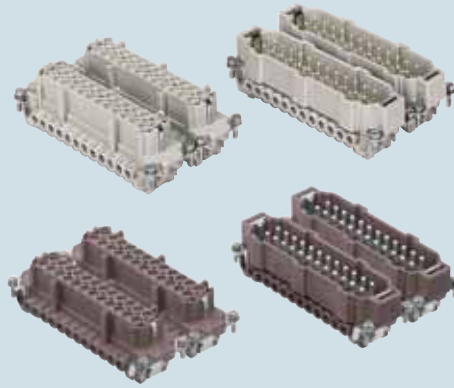

**inserts,
spring terminal connections**

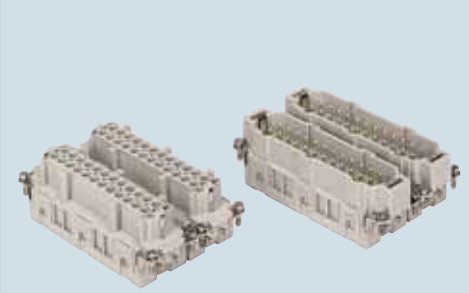

description	part No.	part No.	part No.	part No.
indirect, with plate 1) female inserts, No. (1÷24) and (25÷48) male inserts, No. (1÷24) and (25÷48)	CNEF 24 T CNEM 24 T	CNEF 24 TN CNEM 24 TN		
direct, without plate 2) female inserts, No. (1÷24) and (25÷48) male inserts, No. (1÷24) and (25÷48)	CNEF 24 TX CNEM 24 TX	CNEF 24 TXN CNEM 24 TXN		
indirect, with plate 1), use in temperatures up to 180 °C female inserts, No.(1÷24) and (25÷48), brown male inserts, No. (1÷24) and (25÷48), brown	CNEF 24 RYT * CNEM 24 RYT *	CNEF 24 RYTN * CNEM 24 RYTN *		
spring terminal female inserts, No. (1÷24) and (25÷48) male inserts, No. (1÷24) and (25÷48)			CSEF 24 CSEM 24	CSEF 24 N CSEM 24 N

- 1) for non-prepared conductors
- 2) for bush terminal conductors

* CNE...RY version without plastic wire insertion guide cover available on request.

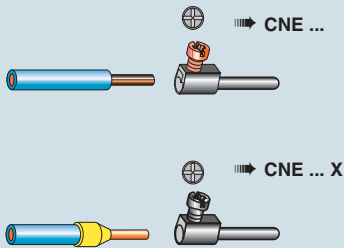

dimensions in mm

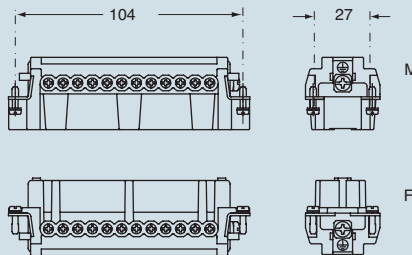

contacts side (front view)

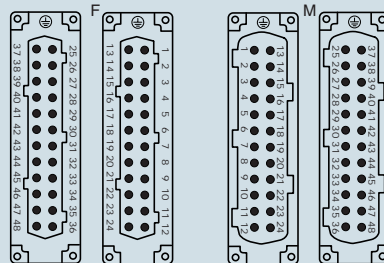

dimensions in mm

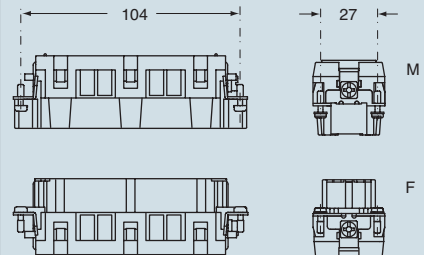

contacts side (front view)

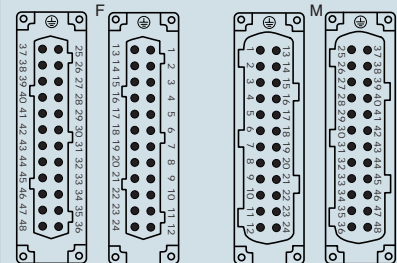

connection with spring terminal

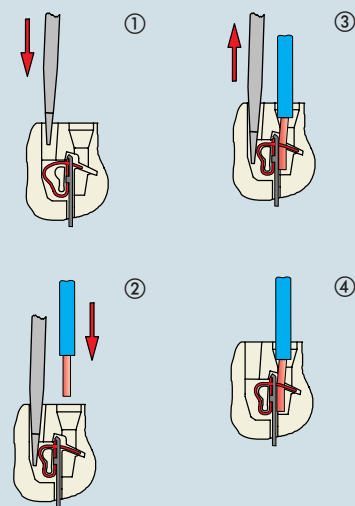

dimensions indicated are not binding and may be changed without notice

- inserts with plate, for section conductors: 0.5 ÷ 2.5 mm² - AWG 20 ÷ 14
- inserts without plate, for section conductors: 0.25 ÷ 2.5 mm² - AWG 24 ÷ 14
- torsion couple recommended for conductor fastening screws and stripping length see section feature of inserts on page 13

- inserts for section conductors: 0.14 ÷ 2.5 mm² - AWG 26 ÷ 14
- stripping length see section feature of inserts on page 13

enclosures: size "44.27"

standard page: 176 ÷ 179
 aggressive environments page: 181
 EMC page: 182

panel supports:
 COB page: 258 ÷ 259

- features according to EN 61984:
16A 500V 6kV 3
- certifications: UL, (CSA), CCC; the certifications shown in brackets are being applied for
- for maximum current load, see the insert load curve section on page 31
- can be mated with CN, CNE, CSE, CCE, CTE, CTSE inserts

inserts,
 connection with dual spring
 terminal per pole



NEW

description	part No.
dual spring terminal per pole socket inserts with female contacts plug inserts with male contacts	CSSF 06 CSSM 06

The CSS series inserts can be inserted in flush mounted enclosures or in fixed / portable high enclosures.

connection with spring terminal

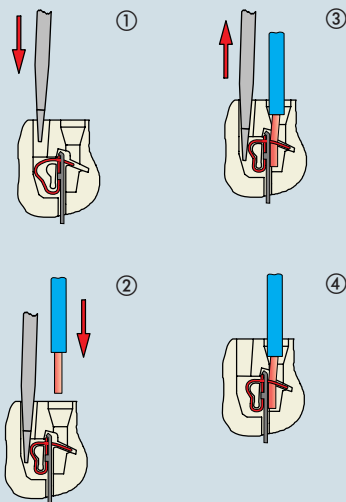

dimensions in mm

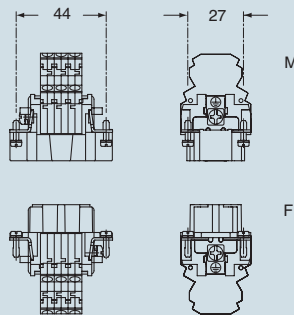

contacts side (front view)

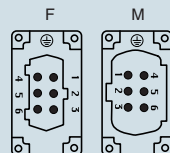

- inserts with plate, for section conductors:
 0.14 ÷ 2.5 mm² - AWG 26 ÷ 14
- stripping length see section feature of inserts
 on page 13

dimensions indicated are not binding
 and may be changed without notice

CSS

enclosures: size "57.27"

standard page: 184 ÷ 188
 aggressive environments page: 195
 EMC page: 196

panel supports:

COB page: 258 ÷ 259

- features according to EN 61984:

16A 500V 6kV 3

- certifications: UL, (CSA), CCC; the certifications shown in brackets are being applied for
- for maximum current load, see the insert load curve section on page 31
- can be mated with CN, CNE, CSE, CCE, CTE, CTSE inserts

inserts,
 connection with dual spring
 terminal per pole



NEW

description

part No.

dual spring terminal per pole
 socket inserts with female contacts
 plug inserts with male contacts

CSSF 10
 CSSM 10

The CSS series inserts can be inserted in flush mounted enclosures or in fixed / portable high enclosures.

dimensions in mm

connection with spring terminal

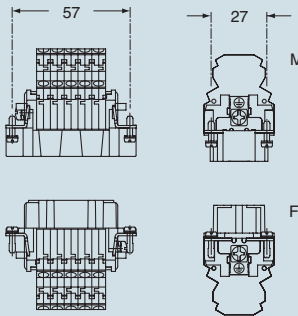
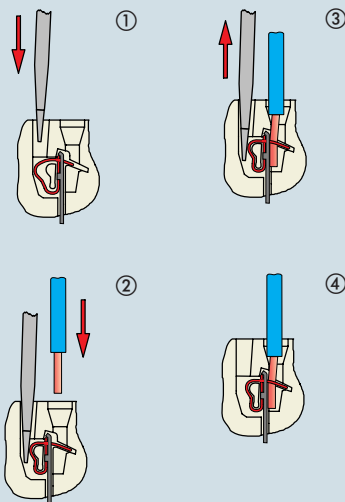

contacts side (front view)

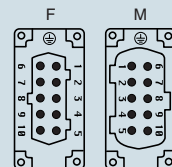

- inserts with plate, for section conductors: 0.14 ÷ 2.5 mm² - AWG 26 ÷ 14
- stripping length see section feature of inserts on page 13

dimensions indicated are not binding and may be changed without notice

enclosures: size "77.27"

standard page: 198 ÷ 202
 aggressive environments page: 209
 EMC page: 210

panel supports:
 COB page: 258 ÷ 259

- features according to EN 61984:
16A 500V 6kV 3
- certifications: UL, (CSA), CCC; the certifications shown in brackets are being applied for
- for maximum current load, see the insert load curve section on page 31
- can be mated with CN, CNE, CSE, CCE, CTE, CTSE inserts

inserts,
 connection with dual spring
 terminal per pole



NEW

description	part No.
dual spring terminal per pole socket inserts with female contacts plug inserts with male contacts	CSSF 16 CSSM 16

The CSS series inserts can be inserted in flush mounted enclosures or in fixed / portable high enclosures.

connection with spring terminal

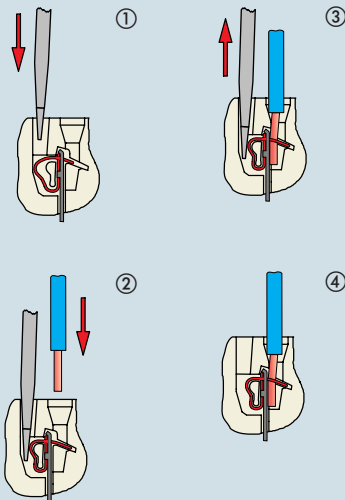

dimensions in mm

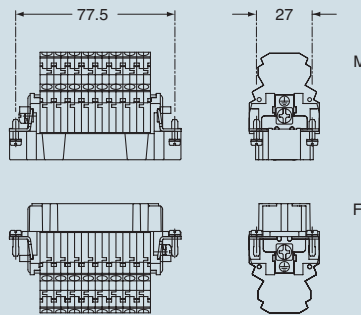

contacts side (front view)

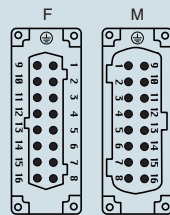

- inserts with plate, for section conductors:
 0.14 ÷ 2.5 mm² - AWG 26 ÷ 14
- stripping length see section feature of inserts
 on page 13

dimensions indicated are not binding
 and may be changed without notice

CSS

enclosures: size "104.27"

standard page: 212 ÷ 216
 aggressive environments page: 223
 EMC page: 224

panel supports:

COB page: 258 ÷ 259

- features according to EN 61984:

16A 500V 6kV 3

- certifications: UL, (CSA), CCC; the certifications shown in brackets are being applied for
- for maximum current load, see the insert load curve section on page 31
- can be mated with CN, CNE, CSE, CCE, CTE, CTSE inserts

inserts,
 connection with dual spring
 terminal per pole

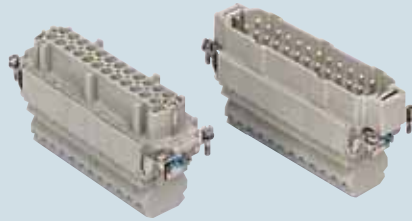

NEW

description

part No.

dual spring terminal per pole
 socket inserts with female contacts
 plug inserts with male contacts

CSSF 24
 CSSM 24

The CSS series inserts can be inserted in flush mounted enclosures or in fixed / portable high enclosures.

dimensions in mm

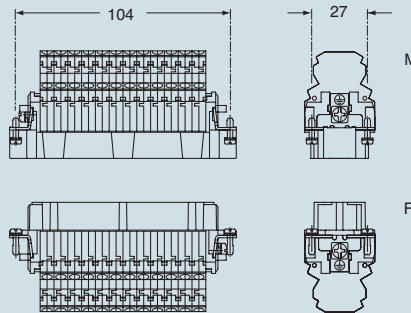

connection with spring terminal

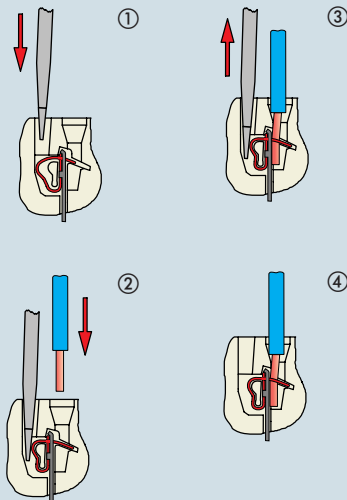

contacts side (front view)

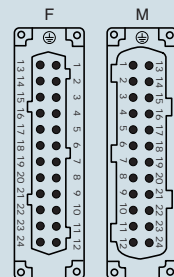

- inserts with plate, for section conductors: 0.14 ÷ 2.5 mm² - AWG 26 ÷ 14
- stripping length see section feature of inserts on page 13

dimensions indicated are not binding
 and may be changed without notice

enclosures: size "77.62"

standard page: 226 ÷ 229

aggressive environments page: 230

- features according to EN 61984: **16A 500V 6kV 3**
- certifications: UL, (CSA), CCC; the certifications shown in brackets are being applied for
- for maximum current load, see the insert load curve section on page 31
- can be mated with CN, CNE, CSE, CCE, CTE, CTSE inserts

inserts,
connection with dual spring
terminal per pole

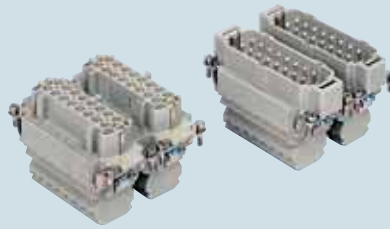

NEW

description	part No.	part No.
dual spring terminal per pole female inserts, No. (1÷16) and (17÷32) male inserts, No. (1÷16) and (17÷32)	CSSF 16 CSSM 16	CSSF 16 N CSSM 16 N

The CSS series inserts can be inserted in flush mounted enclosures or in fixed / portable high enclosures.

connection with spring terminal

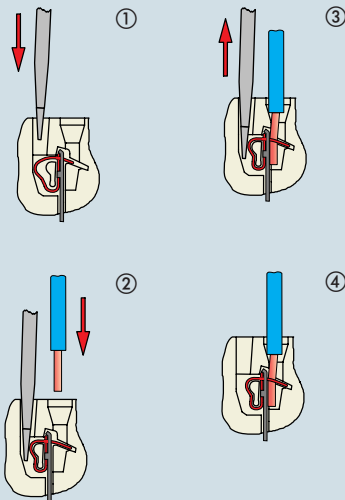

dimensions in mm

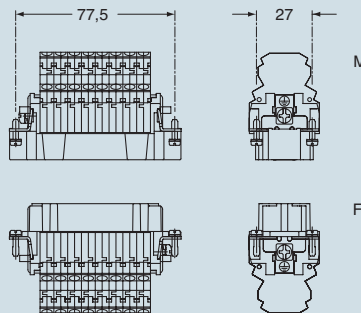

contacts side (front view)

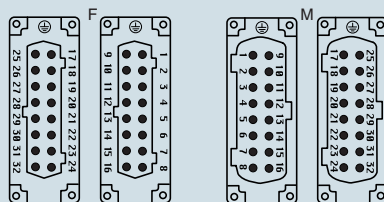

- inserts with plate, for section conductors: 0.14 ÷ 2.5 mm² - AWG 26 ÷ 14
- stripping length see section feature of inserts on page 13

dimensions indicated are not binding and may be changed without notice

CSS

enclosures: size "104.62"
 standard page: 232
 aggressive environments page: 234

- features according to EN 61984: **16A 500V 6kV 3**
- certifications: UL, (CSA), CCC; the certifications shown in brackets are being applied for
- for maximum current load, see the insert load curve section on page 31
- can be mated with CN, CNE, CSE, CCE, CTE, CTSE inserts

inserts,
 connection with dual spring
 terminal per pole

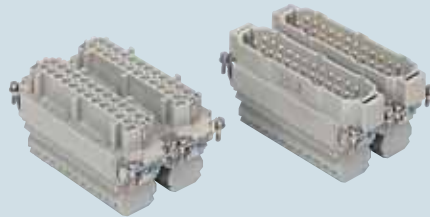

NEW

description	part No.	part No.
dual spring terminal per pole female inserts, No. (1÷24) and (25÷48) male inserts, No. (1÷24) and (25÷48)	CSSF 24 CSSM 24	CSSF 24 N CSSM 24 N

The CSS series inserts can be inserted in flush mounted enclosures or in fixed / portable high enclosures.

connection with spring terminal

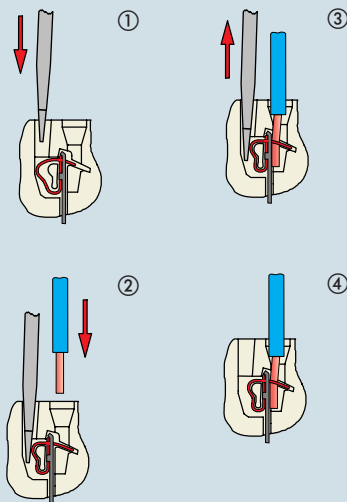

dimensions in mm

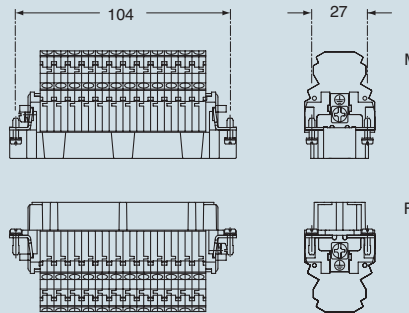

contacts side (front view)

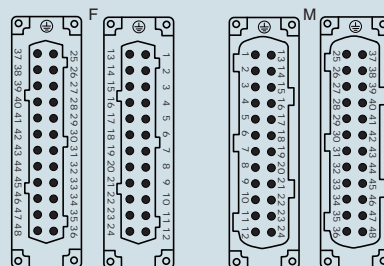

- inserts with plate, for section conductors: 0.14 ÷ 2.5 mm² - AWG 26 ÷ 14
- stripping length see section feature of inserts on page 13

dimensions indicated are not binding
 and may be changed without notice

Use

The CTE-series multipole connectors (with incorporated terminal block) are recommended for greater cost-saving and safety for use on machines and command and control panels.

For control panel mounting, bulkhead housings must be used. This makes it possible to maintain the IP65 degree of protection (in accordance with EN 60529) for coupled housing-mounted connectors.

The CTE series inserts (16A max versions) are supplied in the plug or socket versions and may be mounted with insertion from the front of the enclosure (Figure 1 for all the polarities of the inserts) or with insertion from the rear of the enclosure (Figure 2, only for 16 and 24-pole inserts).

As an alternative to the traditional terminal blocks, the inserts can be mounted inside the control panels on DIN EN rails (Figure 5) using suitable accessories providing the added advantage of easy sectioning.

The special structure of the CTE inserts has all the conductor connections on the same side providing for easier wiring and a complete view of the work area.

The terminal block also has slots for housing the identification wire markers of each contact.

Wire markers of different manufacturers may be used such as: Cabur, Grafoplast, Modernotecnica, Phoenix, Siemens, Wago, Weidmüller.

Figure 1 (front mounting)

The insert is inserted into the bulkhead housing without wired conductors or with pre-wired conductors that are not connected at the opposite end.

Mounting for inserts of 06, 10, 16 and 24 poles

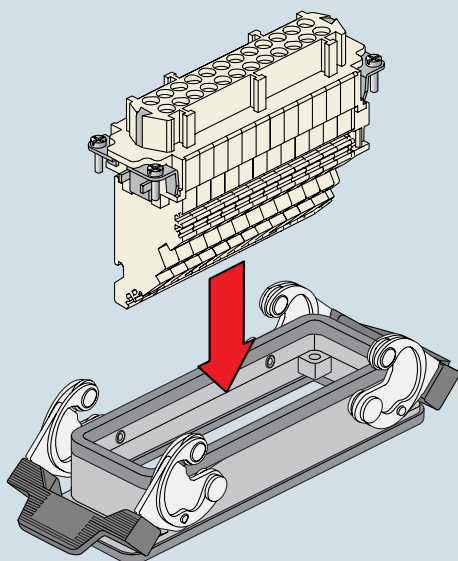

The CTE series is available in the versions "left" and "right" for mounting on the left (Figure 3) or on the right (Figure 4) of the control panel walls.

This characteristic is determined by the position of contact "1" and the ground terminal in the upper part of the insert terminal block for both left and right mounting.

The installation of inserts on DIN rails (Figure 5) inside the control panels is usually made to facilitate the wiring into sectionable parts.

In this case the degree of protection for coupled connectors is IP20 (in accordance with EN 60529).

This type of mounting requires supports (CT APE) to be provided to the inserts suitable for mounting on DIN EN 60715 rails.

Furthermore, to ensure a stable and secure mating between the CTE, CTSE and CT inserts installed on DIN rails and counterparts CNE, CSE, CCE, CN, CS, mating screws CRBF (female) and CRBM (male) are recommended, to replace the ordinary fastening screws to the enclosures (Figure 5).

Figure 2 (rear mounting)

The insert is inserted into the bulkhead housing with pre-wired conductors connected at the opposite end.

Mounting for inserts of 16 and 24 poles

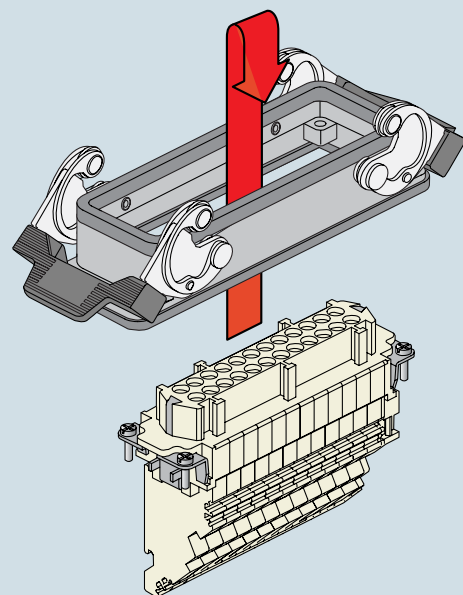

Figure 3 (left mounting)

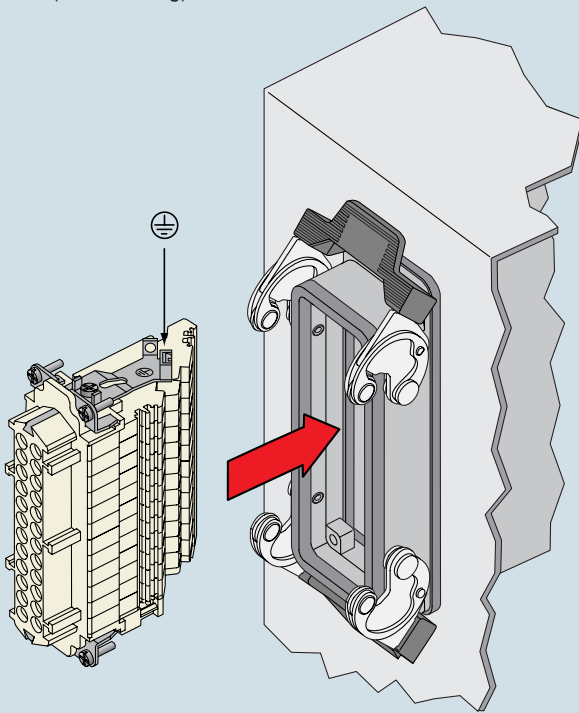

Figure 4 (right mounting)

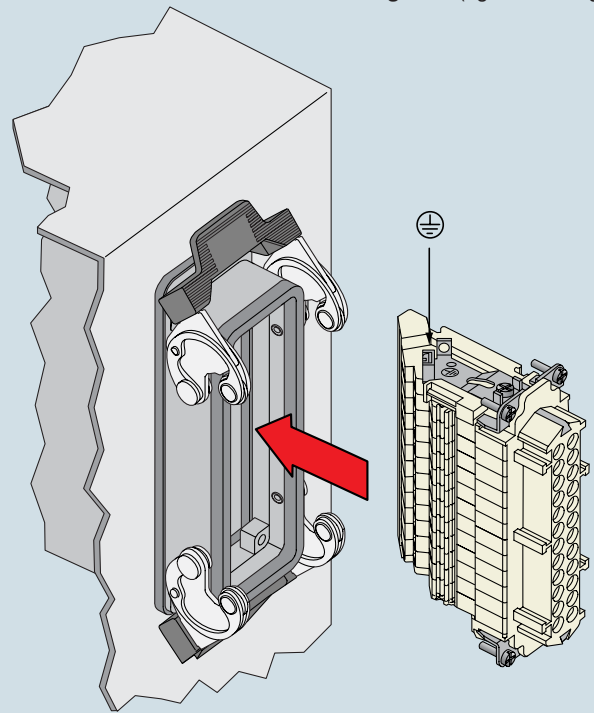
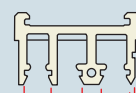
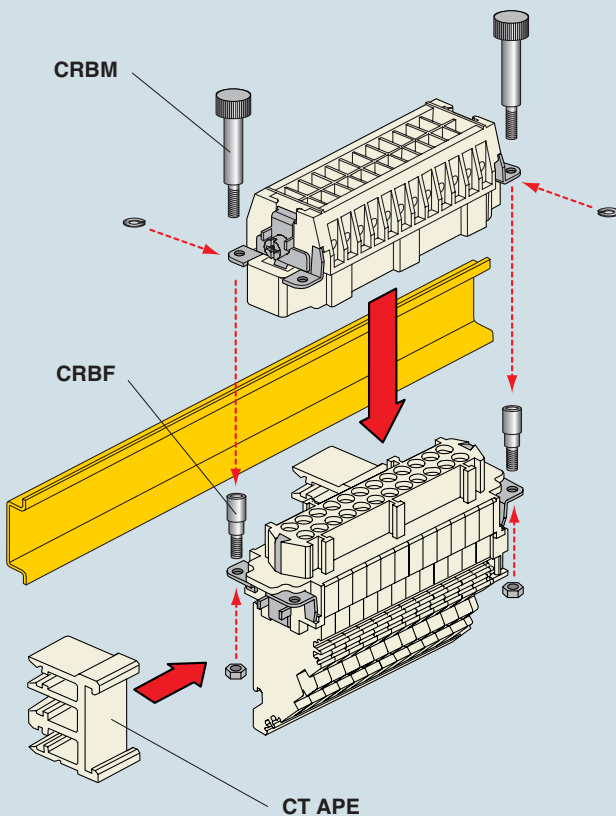

Figure 5 (mounting on DIN rail)



CT APE

possibility of coupling to DIN EN 60715 rail (for a greater stability of the CTE inserts of 16 and 24 poles we recommend using the two CT APE supports)



**EN 60715
C 30**



**EN 60715
G 32**



**EN 60715
TH 35-7.5 e TH 35-15**

accessories for CTE inserts

- support for mounting on DIN rails (**CT APE** page 263)
- inserts coupling screws (**CRBM** and **CRBF** page 263)
- cable-clamping plates (**CRAD** and **CRAS** page 263)

enclosures*): size "44.27"

standard page: 176 ÷ 179
aggressive environments .. page: 181
EMC page: 182

*) only bulkhead mounted housing

- features according to EN 61984:
16A 500V 6kV 3
- CTSE: UL, (CSA), CCC, GL: certified
the certifications shown in brackets are being applied
for (CTE in progress)
- can be mated with CN, CNE, CCE, CCS, CSE inserts
- inserts may be fitted from front of enclosure
- for maximum current load, see the insert load curve
section on page 32

terminal block inserts screw terminal connection



terminal block inserts spring terminal connection



IN PREPARATION

description	part No.	part No.	part No.	part No.
side mounting female inserts with female contacts 1) male inserts with male contacts 1)	left CTEF 06 L CTEM 06 L	right CTEF 06 R CTEM 06 R	left CTSEF 06 L CTSEM 06 L	right CTSEF 06 R CTSEM 06 R
side mounting female inserts with female contacts male inserts with male contacts			left CTSEF 06 L CTSEM 06 L	right CTSEF 06 R CTSEM 06 R

1) for non-prepared conductors

connection with spring terminal

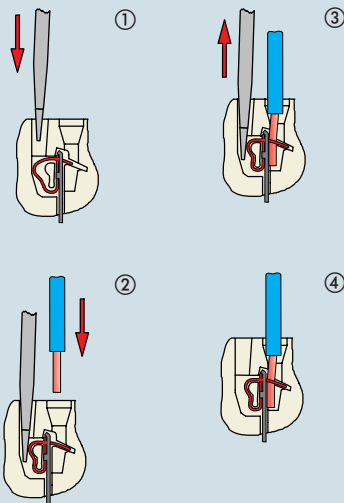

dimensions in mm

female inserts (CTEF and CTSEF)

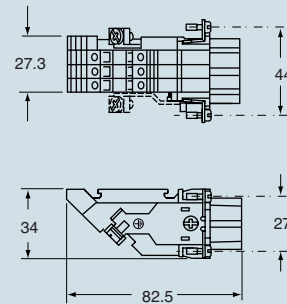

male inserts (CTEM and CTSEM)

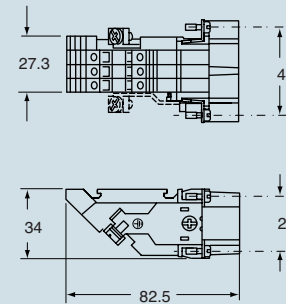

contacts side (front view)

female inserts (CTEF and CTSEF)

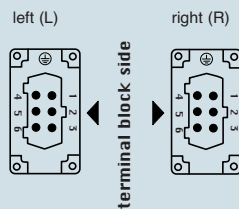

male inserts (CTEM and CTSEM)

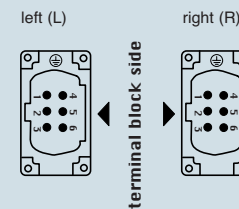

- CTE inserts with plate, for section conductors:
0.75 ÷ 2.5 mm² - AWG 18 ÷ 14
- torsion couple recommended for conductor fastening
screws and stripping length see section feature of
inserts on page 13

- CTSE spring inserts for section conductors:
0.14 ÷ 2.5 mm² - AWG 26 ÷ 14
- stripping length see section feature of inserts
on page 13

dimensions indicated are not binding
and may be changed without notice

enclosures*): **size "57.27"**

standard page: 184 ÷ 188

aggressive environments page: 195

EMC page: 196

*) only bulkhead mounted housing

- features according to EN 61984: **16A 500V 6kV 3**
- CTSE: UL, (CSA), CCC, GL: certified the certifications shown in brackets are being applied for (CTE in progress)
- can be mated with CN, CNE, CCE, CCS, CSE inserts
- inserts may be fitted from front of enclosure
- for maximum current load, see the insert load curve section on page 32

terminal block inserts screw terminal connection



terminal block inserts spring terminal connection



IN PREPARATION

description	part No.	part No.	part No.	part No.
side mounting female inserts with female contacts 1) male inserts with male contacts 1)	left CTEF 10 L CTEM 10 L	right CTEF 10 R CTEM 10 R	left CTSEF 10 L CTSEM 10 L	right CTSEF 10 R CTSEM 10 R
side mounting female inserts with female contacts male inserts with male contacts				

1) for non-prepared conductors

connection with spring terminal

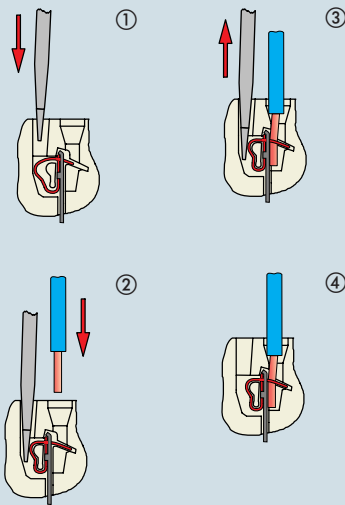

dimensions in mm

female inserts (CTEF and CTSEF)

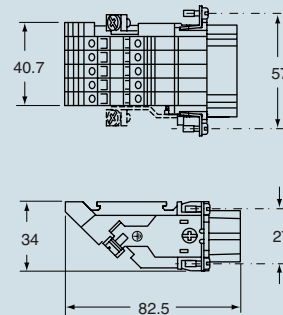

male inserts (CTEM and CTSEM)

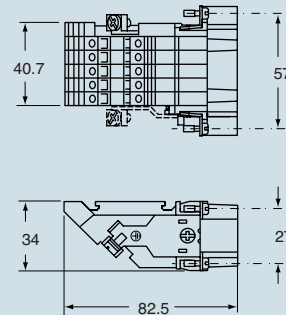

contacts side (front view)

female inserts (CTEF and CTSEF)

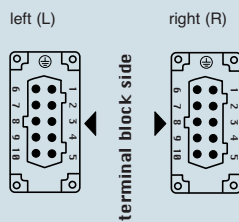

male inserts (CTEM and CTSEM)

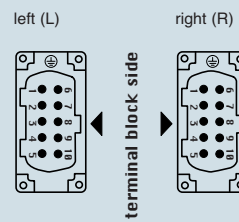

- CTE inserts with plate, for section conductors: 0.75 ÷ 2.5 mm² - AWG 18 ÷ 14
- torsion couple recommended for conductor fastening screws and stripping length see section feature of inserts on page 13

- CTSE spring inserts for section conductors: 0.14 ÷ 2.5 mm² - AWG 26 ÷ 14
- stripping length see section feature of inserts on page 13

dimensions indicated are not binding and may be changed without notice

enclosures*): **size "77.27"**

standard page: 198 ÷ 202
aggressive environments page: 209
EMC page: 210

*) only bulkhead mounted housing

- features according to EN 61984: **16A 500V 6kV 3**
- CTSE: UL, (CSA), CCC, GL: certified the certifications shown in brackets are being applied for (CTE in progress)
- can be mated with CN, CNE, CCE, CCS, CSE inserts
- inserts may be fitted from front or back of enclosure
- for maximum current load, see the insert load curve section on page 32

terminal block inserts screw terminal connection



terminal block inserts spring terminal connection



IN PREPARATION

description	part No.	part No.	part No.	part No.
side mounting female inserts with female contacts 1) male inserts with male contacts 1)	left CTEF 16 L CTEM 16 L	right CTEF 16 R CTEM 16 R	left CTSEF 16 L CTSEM 16 L	right CTSEF 16 R CTSEM 16 R
side mounting female inserts with female contacts male inserts with male contacts				

1) for non-prepared conductors

connection with spring terminal

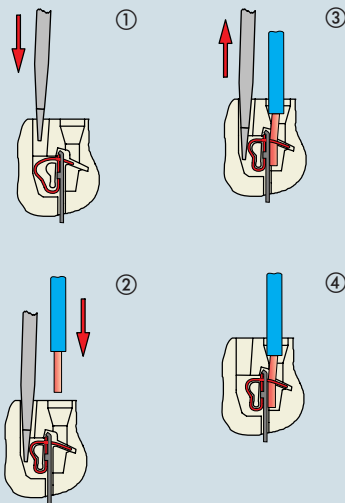

dimensions in mm

female inserts (CTEF and CTSEF)

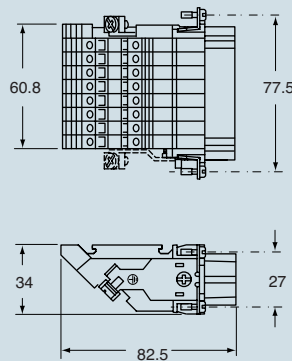

male inserts (CTEM and CTSEM)

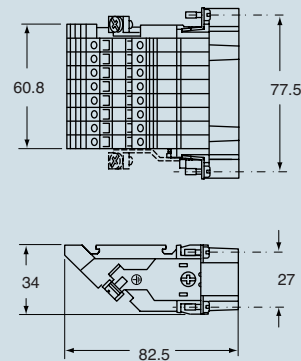

contacts side (front view)

female inserts (CTEF and CTSEF)

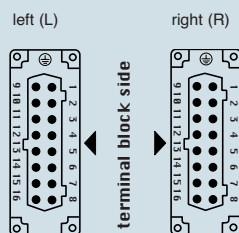

male inserts (CTEM and CTSEM)

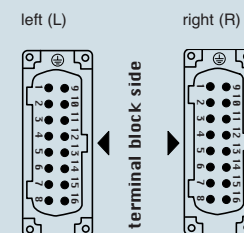

- CTE inserts with plate, for section conductors: 0.75 ÷ 2.5 mm² - AWG 18 ÷ 14
- torsion couple recommended for conductor fastening screws and stripping length see section feature of inserts on page 13

- CTSE spring inserts for section conductors: 0.14 ÷ 2.5 mm² - AWG 26 ÷ 14
- stripping length see section feature of inserts on page 13

dimensions indicated are not binding and may be changed without notice

enclosures*): **size "104.27"**

standard page: 212 ÷ 216
aggressive environments page: 223
EMC page: 224

*) only bulkhead mounted housing

- features according to EN 61984:
16A 500V 6kV 3
- CTSE: UL, (CSA), CCC, GL: certified the certifications shown in brackets are being applied for (CTE in progress)
- can be mated with CN, CNE, CCE, CCS, CSE inserts
- inserts may be fitted from front or back of enclosure
- for maximum current load, see the insert load curve section on page 32

terminal block inserts screw terminal connection



terminal block inserts spring terminal connection



IN PREPARATION

description	part No.	part No.	part No.	part No.
side mounting female inserts with female contacts 1) male inserts with male contacts 1)	left CTEF 24 L CTESE 24 L	right CTEF 24 R CTESE 24 R	left CTSEF 24 L CTSEM 24 L	right CTSEF 24 R CTSEM 24 R
side mounting female inserts with female contacts male inserts with male contacts				

1) for non-prepared conductors

connection with spring terminal

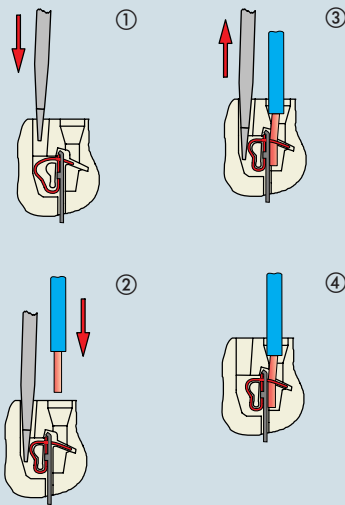

dimensions in mm

female inserts (CTEF and CTSEF)

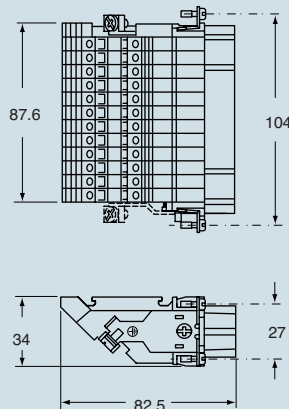

male inserts (CTEM and CTSEM)

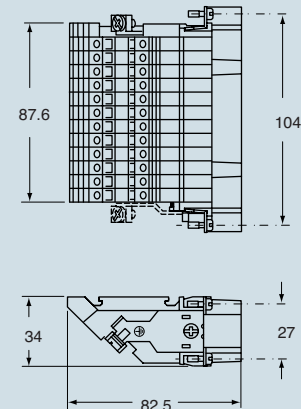

contacts side (front view)

female inserts (CTEF and CTSEF)

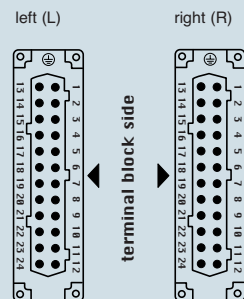

male inserts (CTEM and CTSEM)

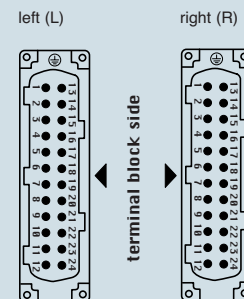

- CTE inserts with plate, for section conductors:
0.75 ÷ 2.5 mm² - AWG 18 ÷ 14
- torsion couple recommended for conductor fastening screws and stripping length see section feature of inserts on page 13

- CTSE spring inserts for section conductors:
0.14 ÷ 2.5 mm² - AWG 26 ÷ 14
- stripping length see section feature of inserts on page 13

dimensions indicated are not binding and may be changed without notice

enclosures*): **size "44.27"**

standard page: 176 ÷ 179
aggressive environments page: 181
EMCpage: 182

*) only bulkhead mounted housing

- features according to EN 61984:
16A 400V 4kV 2
- UL, CSA, CCC, GL certified
- can be mated with CN, CNE, CCE, CSS, CSE inserts
- inserts may be fitted from front of enclosure

terminal block inserts screw terminal connection



description	part No.	part No.
side mounting female inserts with female contacts 1) male inserts with male contacts 1)	left CTF 06 L CTM 06 L	right CTF 06 R CTM 06 R

1) for non-prepared conductors

dimensions in mm

female inserts (CTF)

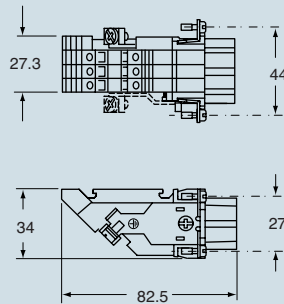

male inserts (CTM)

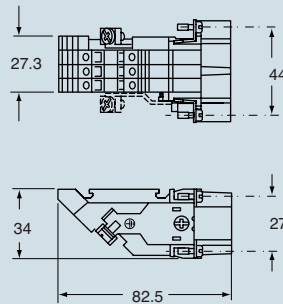

contacts side (front view)

female inserts (CTF)

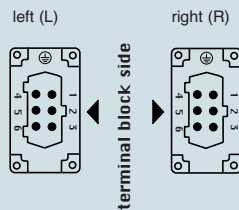

male inserts (CTM)

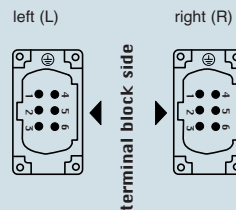

- CT inserts with plate, for section conductors:
0.75 ÷ 2.5 mm² - AWG 18 ÷ 14
- torsion couple recommended for conductor fastening
screws and stripping length see section feature of
inserts on page 13

dimensions indicated are not binding
and may be changed without notice

enclosures*): **size "57.27"**

standard page: 184 ÷ 188
aggressive environments page: 195
EMC page: 196

*) only bulkhead mounted housing,

- features according to EN 61984:
16A 400V 4kV 2
- UL, CSA, CCC, GL certified
- can be mated with CN, CNE, CCE, CSS, CSE inserts
- inserts may be fitted from front of enclosure

terminal block inserts screw terminal connection



description	part No.	part No.
side mounting female inserts with female contacts 1) male inserts with male contacts 1)	left CTF 10 L CTM 10 L	right CTF 10 R CTM 10 R

1) for non-prepared conductors

dimensions in mm

female inserts (CTF)

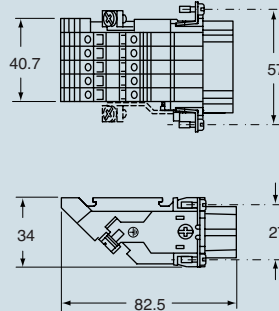

male inserts (CTM)

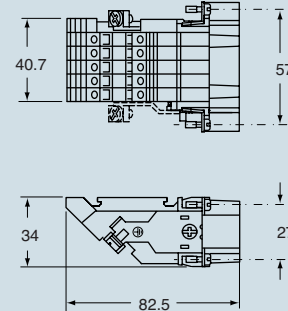

contacts side (front view)

female inserts (CTF)

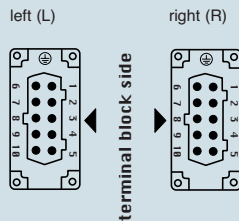

male inserts (CTM)

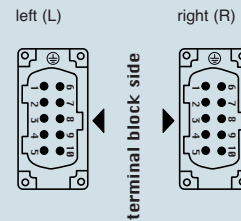

- CT inserts with plate, for section conductors:
0.75 ÷ 2.5 mm² - AWG 18 ÷ 14
- torsion couple recommended for conductor fastening
screws and stripping length see section feature of
inserts on page 13

dimensions indicated are not binding
and may be changed without notice

enclosures*): **size "77.27"**

standard page: 198 ÷ 202

aggressive environments page: 209

EMC page: 210

*) only bulkhead mounted housing

- features according to EN 61984:
- 16A 400V 4kV 2**
- UL, CSA, CCC, GL certified
- can be mated with CN, CNE, CCE, CSS, CSE inserts
- inserts may be fitted from front or back of enclosure

terminal block inserts screw terminal connection



description	part No.	part No.
side mounting female inserts with female contacts 1) male inserts with male contacts 1)	left CTF 16 L CTM 16 L	right CTF 16 R CTM 16 R

1) for non-prepared conductors

dimensions in mm

female inserts (CTF)

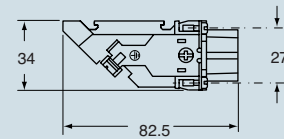
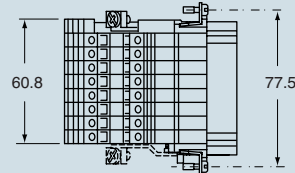

male inserts (CTM)

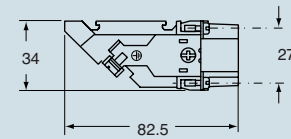
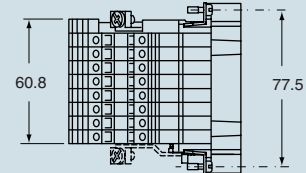

contacts side (front view)

female inserts (CTF)

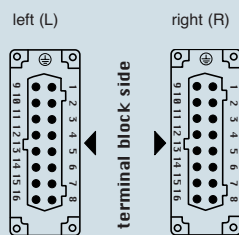

male inserts (CTM)

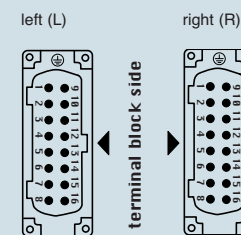

- CT inserts with plate, for section conductors:
0.75 ÷ 2.5 mm² - AWG 18 ÷ 14
- torsion couple recommended for conductor fastening screws and stripping length see section feature of inserts on page 13

dimensions indicated are not binding
and may be changed without notice

enclosures: **size "104.27"**

standard page: 212 ÷ 216
aggressive environments page: 223
EMC page: 224

*) only bulkhead mounted housing

- features according to EN 61984:
16A 400V 4kV 2
- UL, CSA, CCC, GL certified
- can be mated with CN, CNE, CCE, CSS, CSE inserts
- inserts may be fitted from front or back of enclosure

terminal block inserts screw terminal connection



description	part No.	part No.
side mounting female inserts with female contacts 1) male inserts with male contacts 1)	left CTF 24 L CTM 24 L	right CTF 24 R CTM 24 R

1) for non-prepared conductors

dimensions in mm

female inserts (CTF)

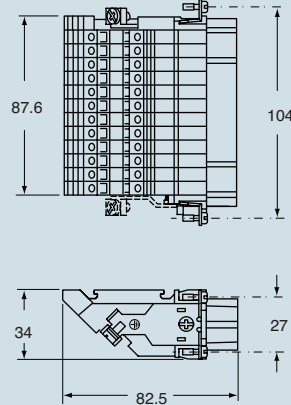

male inserts (CTM)

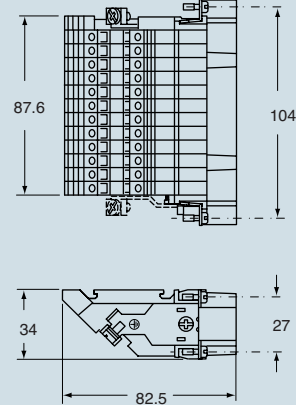

contacts side (front view)

female inserts (CTF)

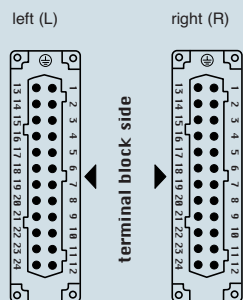

male inserts (CTM)

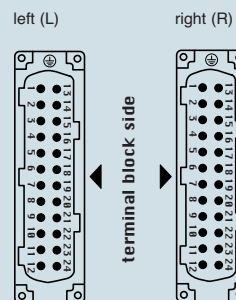

- CT inserts with plate, for section conductors:
0.75 ÷ 2.5 mm² - AWG 18 ÷ 14
- torsion couple recommended for conductor fastening
screws and stripping length see section feature of
inserts on page 13

dimensions indicated are not binding
and may be changed without notice

enclosures: size "57.27"

standard page: 184 ÷ 188
aggressive environments page: 195
EMC page: 196

panel supports:

COB page: 258 ÷ 259

- features according to EN 61984:

- 16A 830V 8kV 3**
- auxiliary contacts: **16A 500V 6kV 3**
- certifications: UL, (CSA), CCC; the certifications shown in brackets are being applied for
- for maximum current load, see the insert load curve section on page 32
- for contact crimping instructions, please see the crimping tool section (16A contacts, CCF, CCM and CC...AN series) on pages 296, 300, 304, 306, 308

inserts,
spring terminal connection

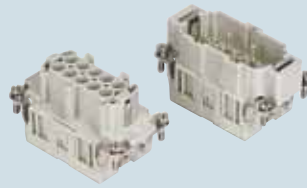

inserts, crimp connections
16A normal and for advanced opening
silver and gold plated contacts

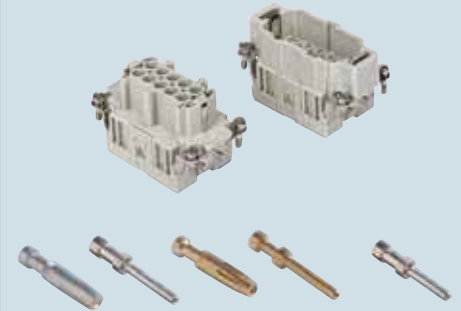

description	part No.	part No.	part No.
female inserts with female contacts male inserts with male contacts	CMSEF 03 CMSEM 03		
without contacts (to be ordered separately) female inserts for female contacts male inserts for male contacts		CMCEF 03 CMCEM 03	
16A female contacts 0.5 mm ² AWG 20 with no grooves 0.75 mm ² AWG 18 one groove (back side) 1 mm ² AWG 18 one groove 1.5 mm ² AWG 16 two grooves 2.5 mm ² AWG 14 three grooves 3 mm ² AWG 12 one wide groove 4 mm ² AWG 12 with no grooves		CCFA 0.5 CCFA 0.7 CCFA 1.0 CCFA 1.5 CCFA 2.5 CCFA 3.0 CCFA 4.0	CCFD 0.5 CCFD 0.7 CCFD 1.0 CCFD 1.5 CCFD 2.5 CCFD 3.0 CCFD 4.0
16A male contacts 0.5 mm ² AWG 20 with no grooves 0.75 mm ² AWG 18 one groove (back side) 1 mm ² AWG 18 one groove 1.5 mm ² AWG 16 two grooves 2.5 mm ² AWG 14 three grooves 3 mm ² AWG 12 one wide groove 4 mm ² AWG 12 with no grooves		CCMA 0.5 CCMA 0.7 CCMA 1.0 CCMA 1.5 CCMA 2.5 CCMA 3.0 CCMA 4.0	CCMD 0.5 CCMD 0.7 CCMD 1.0 CCMD 1.5 CCMD 2.5 CCMD 3.0 CCMD 4.0
16A male crimp contacts for advanced opening 0.5 mm ² AWG 20 with no grooves 0.75 mm ² AWG 18 one groove (back side) 1 mm ² AWG 18 one groove 1.5 mm ² AWG 16 two grooves 2.5 mm ² AWG 14 three grooves		CC 0.5 AN CC 0.7 AN CC 1.0 AN CC 1.5 AN CC 2.5 AN	

silver plated

gold plated

dimensions of crimp contacts in mm
(for CMCE inserts)

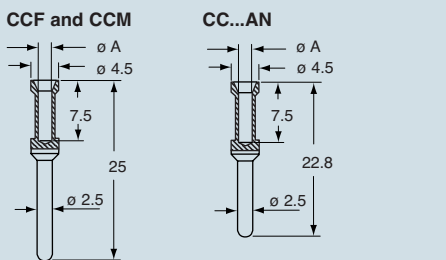

CCF, CCM and CC..AN contacts

conductor section mm ²	ø slot A (mm)
0.5	1.1
0.75	1.3
1.0	1.45
1.5	1.8
2.5	2.2
3	2.55
4	2.85

- stripping length see section feature of inserts on page 13

dimensions indicated are not binding and may be changed without notice

dimensions in mm

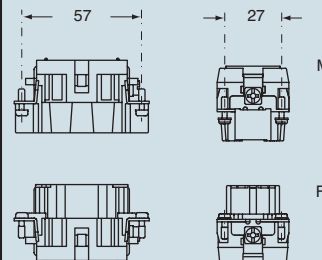

contacts side (front view)

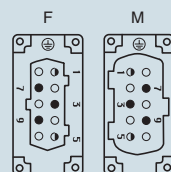

ⓘ the auxiliary contacts are in the forward position upon opening

- inserts for section conductors:
0.14 ÷ 2.5 mm² - AWG 26 ÷ 14

- stripping length see section feature of inserts on page 13

dimensions in mm

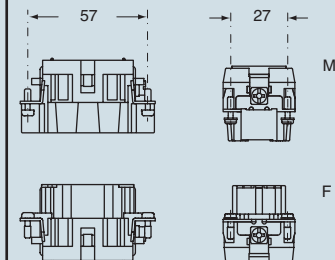

contacts side (front view)

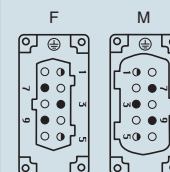

ⓘ the auxiliary contacts are in the forward position upon opening

enclosures: **size "57.27"**

insulated 830V page: 189 ÷ 193
aggressive environments page: 195

panel supports:

COB page: 258 ÷ 259

- features according to EN 61984:

- 16A 830V 8kV 3**
- auxiliary contacts: **16A 500V 6kV 3**
- certifications: UL, (CSA), CCC; the certifications shown in brackets are being applied for
- for maximum current load, see the insert load curve section on page 32

**inserts,
screw terminal connection**

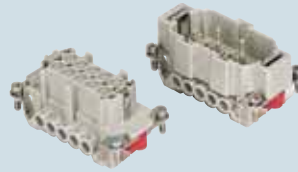

description	part No.
-------------	----------

indirect, with plate 1) female inserts with female contacts male inserts with male contacts	CMEF 03 T CMEM 03 T
---	--------------------------------------

direct, without plate 2) female inserts with female contacts male inserts with male contacts	CMEF 03 TX CMEM 03 TX
--	--

- 1) for non-prepared conductors
- 2) for bush terminal conductors

dimensions in mm

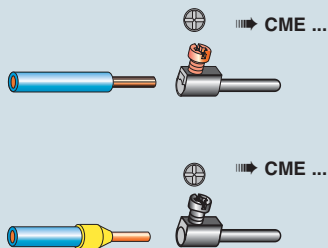
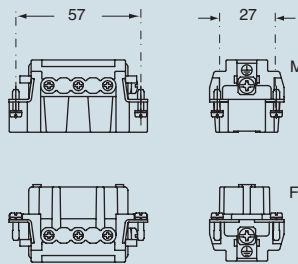

contacts side (front view)

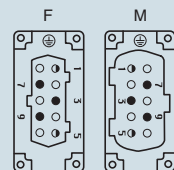

● the auxiliary contacts are in the forward position upon opening

- inserts with plate, for section conductors:
0.5 ÷ 2.5 mm² - AWG 20 ÷ 14
- inserts without plate, for section conductors:
0.25 ÷ 2.5 mm² - AWG 24 ÷ 14
- torsion couple recommended for conductor fastening screws and stripping length see section feature of inserts on page 13

dimensions indicated are not binding and may be changed without notice

enclosures: **size "77.27"**

standard page: 198 ÷ 202
aggressive environments page: 209
EMC page: 210

panel supports:

COB page: 258 ÷ 259

- features according to EN 61984:

- 16A 830V 8kV 3**
- auxiliary contacts: **16A 500V 6kV 3**
- certifications: UL, (CSA), CCC; the certifications shown in brackets are being applied for
- for maximum current load, see the insert load curve section on page 32
- for contact crimping instructions, please see the crimping tool section (16A contacts, CCF, CCM and CC...AN series) on pages 296, 300, 304, 306, 308

inserts, spring terminal connection

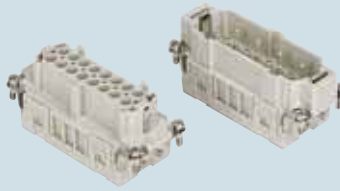

inserts, crimp connections
16A normal and for advanced opening
silver and gold plated contacts

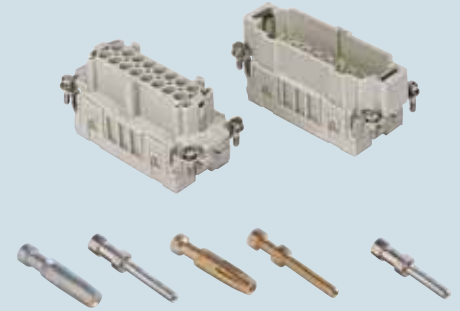

description	part No.	part No.	part No.
female inserts with female contacts male inserts with male contacts	CMSEF 06 CMSEM 06		
female inserts with female contacts female inserts for female contacts male inserts for male contacts		CMCEF 06 CMCEM 06	
16A female contacts 0.5 mm ² AWG 20 with no grooves 0.75 mm ² AWG 18 one groove (back side) 1 mm ² AWG 18 one groove 1.5 mm ² AWG 16 two grooves 2.5 mm ² AWG 14 three grooves 3 mm ² AWG 12 one wide groove 4 mm ² AWG 12 with no grooves		CCFA 0.5 CCFA 0.7 CCFA 1.0 CCFA 1.5 CCFA 2.5 CCFA 3.0 CCFA 4.0	CCFD 0.5 CCFD 0.7 CCFD 1.0 CCFD 1.5 CCFD 2.5 CCFD 3.0 CCFD 4.0
16A male contacts 0.5 mm ² AWG 20 with no grooves 0.75 mm ² AWG 18 one groove (back side) 1 mm ² AWG 18 one groove 1.5 mm ² AWG 16 two grooves 2.5 mm ² AWG 14 three grooves 3 mm ² AWG 12 one wide groove 4 mm ² AWG 12 with no grooves		CCMA 0.5 CCMA 0.7 CCMA 1.0 CCMA 1.5 CCMA 2.5 CCMA 3.0 CCMA 4.0	CCMD 0.5 CCMD 0.7 CCMD 1.0 CCMD 1.5 CCMD 2.5 CCMD 3.0 CCMD 4.0
16A male crimp contacts for advanced opening 0.5 mm ² AWG 20 with no grooves 0.75 mm ² AWG 18 one groove (back side) 1 mm ² AWG 18 one groove 1.5 mm ² AWG 16 two grooves 2.5 mm ² AWG 14 three grooves		CC 0.5 AN CC 0.7 AN CC 1.0 AN CC 1.5 AN CC 2.5 AN	

silver plated

gold plated

dimensions of crimp contacts in mm
(for CMCE inserts)

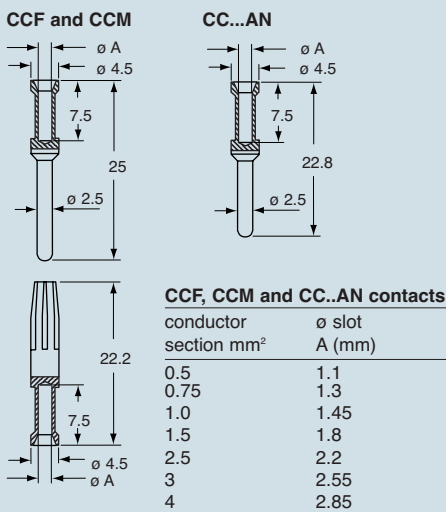

- stripping length see section feature of inserts on page 13

dimensions indicated are not binding and may be changed without notice

dimensions in mm

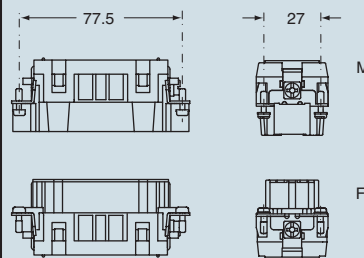

contacts side (front view)

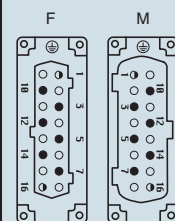

ⓘ the auxiliary contacts are in the forward position upon opening

- inserts for section conductors: 0.14 ÷ 2.5 mm² - AWG 26 ÷ 14
- stripping length see section feature of inserts on page 13

dimensions in mm

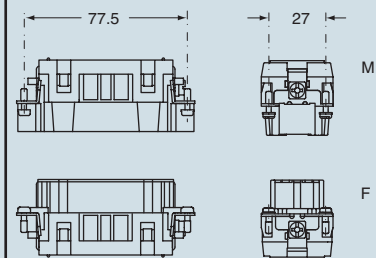

contacts side (front view)

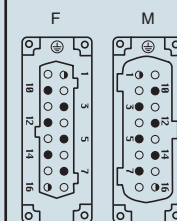

ⓘ the auxiliary contacts are in the forward position upon opening

enclosures: size "77.27"

insulated 830V page: 203 ÷ 207
 aggressive environments page: 209

panel supports:
 COB page: 258 ÷ 259

- features according to EN 61984:
16A 830V 8kV 3
- auxiliary contacts: **16A 500V 6kV 3**
- certifications: UL, (CSA), CCC; the certifications shown in brackets are being applied for
- for maximum current load, see the insert load curve section on page 32

**inserts,
 screw terminal connection**

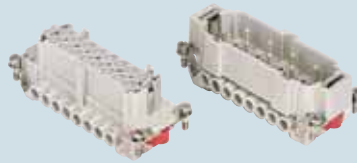

description	part No.
-------------	----------

indirect, with plate 1) female inserts with female contacts male inserts with male contacts	CMEF 06 T CMEM 06 T
---	--------------------------------------

direct, without plate 2) female inserts with female contacts male inserts with male contacts	CMEF 06 TX CMEM 06 TX
--	--

- 1) for non-prepared conductors
- 2) for bush terminal conductors

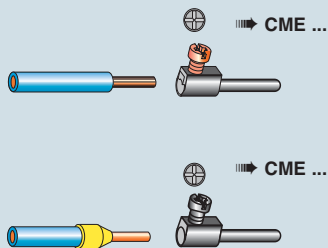

dimensions in mm

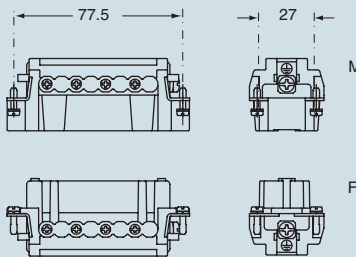

contacts side (front view)

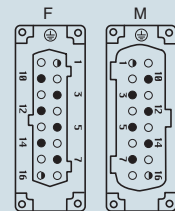

● the auxiliary contacts are in the forward position upon opening

- inserts with plate, for section conductors:
 0.5 ÷ 2.5 mm² - AWG 20 ÷ 14
- inserts without plate, for section conductors:
 0.25 ÷ 2.5 mm² - AWG 24 ÷ 14
- torsion couple recommended for conductor fastening screws and stripping length see section feature of inserts on page 13

dimensions indicated are not binding and may be changed without notice



enclosures: **size "104.27"**

standard page: 212 ÷ 216
aggressive environments page: 223
EMC page: 224

panel supports:

COB page: 258 ÷ 259

- features according to EN 61984:

16A 830V 8kV 3

- auxiliary contacts: **16A 500V 6kV 3**

- certifications: UL, (CSA), CCC; the certifications shown in brackets are being applied for
 - for maximum current load, see the insert load curve section on page 32

- for contact crimping instructions, please see the crimping tool section (16A contacts, CCF, CCM and CC...AN series) on pages 296, 300, 304, 306, 308

**inserts,
spring terminal connection**



**inserts, crimp connections
16A normal and for advanced opening
silver and gold plated contacts**

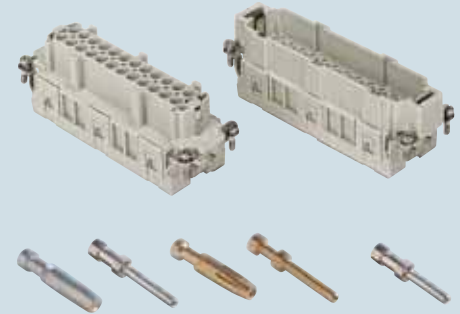

description	part No.	part No.	part No.
female inserts with female contacts male inserts with male contacts	CMSEF 10 CMSEM 10		
without contacts (to be ordered separately) female inserts for female contacts male inserts for male contacts		CMCEF 10 CMCEM 10	
16A female contacts 0.5 mm ² AWG 20 with no grooves 0.75 mm ² AWG 18 one groove (back side) 1 mm ² AWG 18 one groove 1.5 mm ² AWG 16 two grooves 2.5 mm ² AWG 14 three grooves 3 mm ² AWG 12 one wide groove 4 mm ² AWG 12 with no grooves		CCFA 0.5 CCFA 0.7 CCFA 1.0 CCFA 1.5 CCFA 2.5 CCFA 3.0 CCFA 4.0	CCFD 0.5 CCFD 0.7 CCFD 1.0 CCFD 1.5 CCFD 2.5 CCFD 3.0 CCFD 4.0
16A male contacts 0.5 mm ² AWG 20 with no grooves 0.75 mm ² AWG 18 one groove (back side) 1 mm ² AWG 18 one groove 1.5 mm ² AWG 16 two grooves 2.5 mm ² AWG 14 three grooves 3 mm ² AWG 12 one wide groove 4 mm ² AWG 12 with no grooves		CCMA 0.5 CCMA 0.7 CCMA 1.0 CCMA 1.5 CCMA 2.5 CCMA 3.0 CCMA 4.0	CCMD 0.5 CCMD 0.7 CCMD 1.0 CCMD 1.5 CCMD 2.5 CCMD 3.0 CCMD 4.0
16A male crimp contacts for advanced opening 0.5 mm ² AWG 20 with no grooves 0.75 mm ² AWG 18 one groove (back side) 1 mm ² AWG 18 one groove 1.5 mm ² AWG 16 two grooves 2.5 mm ² AWG 14 three grooves		CC 0.5 AN CC 0.7 AN CC 1.0 AN CC 1.5 AN CC 2.5 AN	

silver plated

gold plated

dimensions of crimp contacts in mm
(for CMCE inserts)

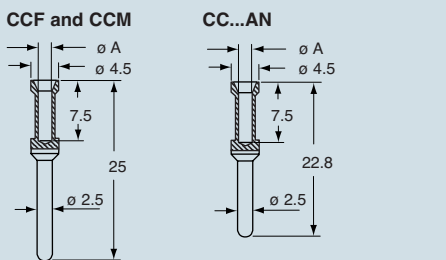

CCF, CCM and CC...AN contacts

conductor section mm ²	ø slot A (mm)
0.5	1.1
0.75	1.3
1.0	1.45
1.5	1.8
2.5	2.2
3	2.55
4	2.85

- stripping length see section feature of inserts on page 13

dimensions in mm

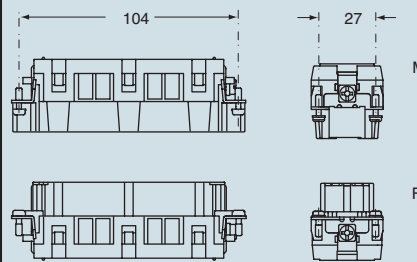

contacts side (front view)

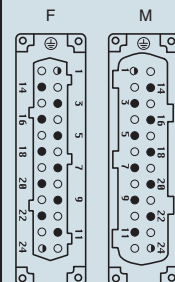

● the auxiliary contacts are in the forward position upon opening

- inserts for section conductors:
0.14 ÷ 2.5 mm² - AWG 26 ÷ 14

- stripping length see section feature of inserts on page 13

dimensions in mm

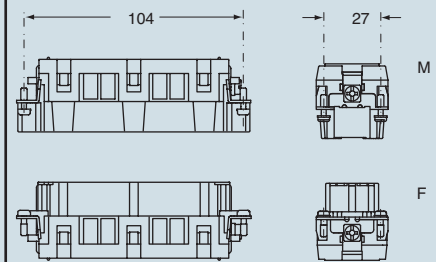

contacts side (front view)

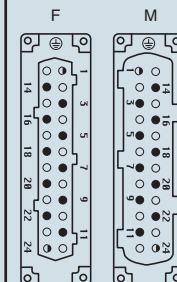

● the auxiliary contacts are in the forward position upon opening

dimensions indicated are not binding and may be changed without notice

enclosures: **size "104.27"**

insulated 830V page: 217 ÷ 221

aggressive environments page: 223

panel supports:

COB page: 258 ÷ 259

- features according to EN 61984:

16A 830V 8kV 3

- auxiliary contacts: **16A 500V 6kV 3**

- certifications: UL, (CSA), CCC; the certifications shown in brackets are being applied for

- for maximum current load, see the insert load curve section on page 32

**inserts,
screw terminal connection**

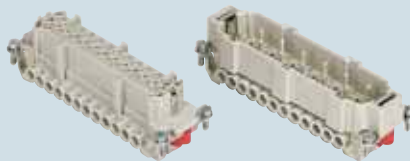

description	part No.
-------------	----------

indirect, with plate 1) female inserts with female contacts male inserts with male contacts	CMEF 10 T CMEM 10 T
---	--------------------------------------

direct, without plate 2) female inserts with female contacts male inserts with male contacts	CMEF 10 TX CMEM 10 TX
--	--

- 1) for non-prepared conductors
- 2) for bush terminal conductors

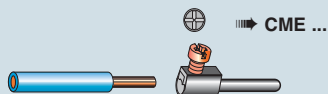

dimensions in mm

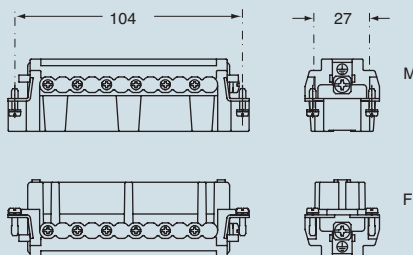

contacts side (front view)

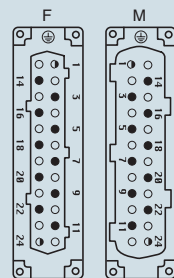

● the auxiliary contacts are in the forward position upon opening

- inserts with plate, for section conductors:
0.5 ÷ 2.5 mm² - AWG 20 ÷ 14
- inserts without plate, for section conductors:
0.25 ÷ 2.5 mm² - AWG 24 ÷ 14
- torsion couple recommended for conductor fastening screws and stripping length see section feature of inserts on page 13

dimensions indicated are not binding and may be changed without notice

enclosures: size "77.62"

standard page: 226 ÷ 229
 aggressive environments page: 230

- features according to EN 61984:
16A 830V 8kV 3
- auxiliary contacts: **16A 500V 6kV 3**
- certifications: UL, (CSA), CCC; the certifications shown in brackets are being applied for
- for maximum current load, see the insert load curve section on page 32
- for contact crimping instructions, please see the crimping tool section (16A contacts, CCF, CCM and CC...AN series) on pages 296, 300, 304, 306, 308

inserts,
spring terminal connection

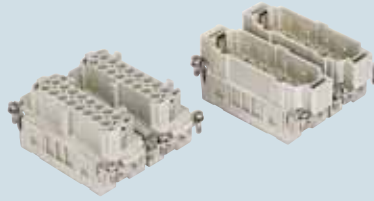

inserts, crimp connections
16A normal and for advanced opening
silver and gold plated contacts

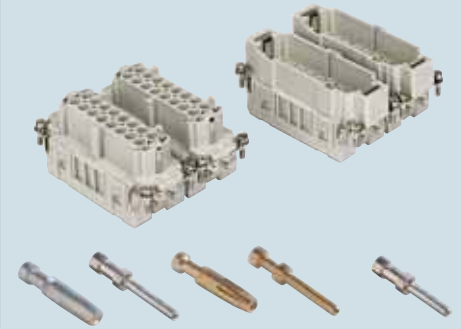

description	part No.	part No.	part No.	part No.
female inserts, No. (1÷16) and (17÷32) male inserts, No. (1÷16) and (17÷32)	CMSEF 06 CMSEM 06	CMSEF 06 N CMSEM 06 N		
without contacts (to be ordered separately) female inserts, No. (1÷16) and (17÷32) male inserts, No. (1÷16) and (17÷32)			CMCEF 06 CMCEM 06	CMCEF 06 N CMCEM 06 N
16A female contacts 0.5 mm ² AWG 20 with no grooves 0.75 mm ² AWG 18 one groove (back side) 1 mm ² AWG 18 one groove 1.5 mm ² AWG 16 two grooves 2.5 mm ² AWG 14 three grooves 3 mm ² AWG 12 one wide groove 4 mm ² AWG 12 with no grooves			CCFA 0.5 CCFA 0.7 CCFA 1.0 CCFA 1.5 CCFA 2.5 CCFA 3.0 CCFA 4.0	CCFD 0.5 CCFD 0.7 CCFD 1.0 CCFD 1.5 CCFD 2.5 CCFD 3.0 CCFD 4.0
16A male contacts 0.5 mm ² AWG 20 with no grooves 0.75 mm ² AWG 18 one groove (back side) 1 mm ² AWG 18 one groove 1.5 mm ² AWG 16 two grooves 2.5 mm ² AWG 14 three grooves 3 mm ² AWG 12 one wide groove 4 mm ² AWG 12 with no grooves			CCMA 0.5 CCMA 0.7 CCMA 1.0 CCMA 1.5 CCMA 2.5 CCMA 3.0 CCMA 4.0	CCMD 0.5 CCMD 0.7 CCMD 1.0 CCMD 1.5 CCMD 2.5 CCMD 3.0 CCMD 4.0
16A male crimp contacts for advanced opening 0.5 mm ² AWG 20 with no grooves 0.75 mm ² AWG 18 one groove (back side) 1 mm ² AWG 18 one groove 1.5 mm ² AWG 16 two grooves 2.5 mm ² AWG 14 three grooves			CC 0.5 AN CC 0.7 AN CC 1.0 AN CC 1.5 AN CC 2.5 AN	

silver plated

gold plated

dimensions of crimp contacts in mm
(for CMCE inserts)

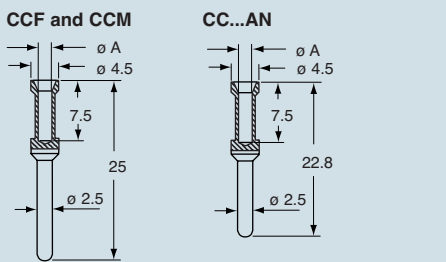

CCF, CCM and CC...AN contacts

conductor section mm ²	ø slot A (mm)
0.5	1.1
0.75	1.3
1.0	1.45
1.5	1.8
2.5	2.2
3	2.55
4	2.85

- stripping length see section feature of inserts on page 13

dimensions in mm

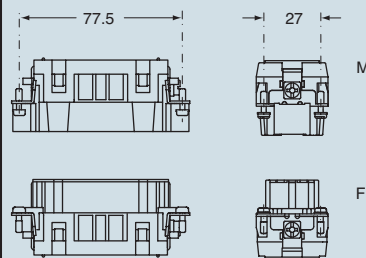

contacts side (front view)

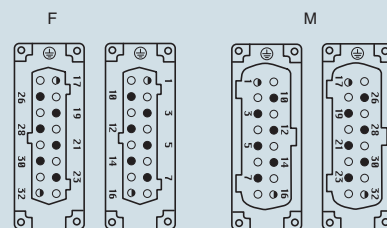

the auxiliary contacts are in the forward position upon opening

- inserts for section conductors: 0.14 ÷ 2.5 mm² - AWG 26 ÷ 14
- stripping length see section feature of inserts on page 13

dimensions in mm

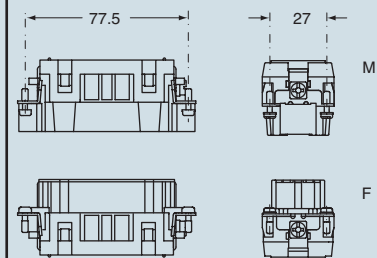

contacts side (front view)

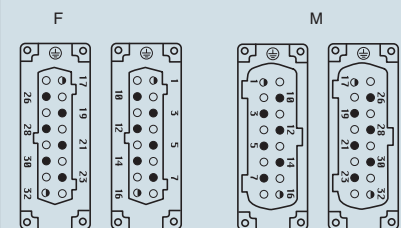

the auxiliary contacts are in the forward position upon opening

dimensions indicated are not binding and may be changed without notice

enclosures: size "77.62"

standard page: 226 ÷ 229

aggressive environments page: 230

- features according to EN 61984:

16A 830V 8kV 3

- auxiliary contacts: **16A 500V 6kV 3**

- certifications: UL, (CSA), CCC; the certifications shown in brackets are being applied for

- for maximum current load, see the insert load curve section on page 32

inserts,
screw terminal connection

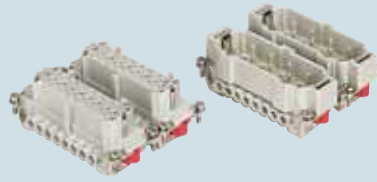

description	part No.	part No.
indirect, with plate 1) female inserts, No. (1÷16) and (17÷32) male inserts, No. (1÷16) and (17÷32)	CMEF 06 T CMEM 06 T	CMEF 06 TN CMEM 06 TN
direct, without plate 2) female inserts, No. (1÷16) and (17÷32) male inserts, No. (1÷16) and (17÷32)	CMEF 06 TX CMEM 06 TX	CMEF 06 TXN CMEM 06 TXN

- 1) for non-prepared conductors
- 2) for bush terminal conductors

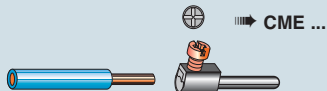

dimensions in mm

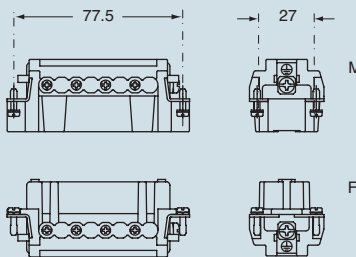

contacts side (front view)

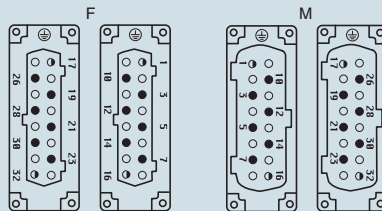

ⓘ the auxiliary contacts are in the forward position upon opening

- inserts with plate, for section conductors:
0.5 ÷ 2.5 mm² - AWG 20 ÷ 14
- inserts without plate, for section conductors:
0.25 ÷ 2.5 mm² - AWG 24 ÷ 14
- torsion couple recommended for conductor fastening screws and stripping length see section feature of inserts on page 13

dimensions indicated are not binding
and may be changed without notice

enclosures: size "104.62"

standard page: 232

aggressive environments page: 234

- features according to EN 61984:

16A 830V 8kV 3

- auxiliary contacts: **16A 500V 6kV 3**

- certifications: UL, (CSA), CCC; the certifications shown in brackets are being applied for
- for maximum current load, see the insert load curve section on page 32

- for contact crimping instructions, please see the crimping tool section (16A contacts, CCF, CCM and CC...AN series) on pages 296, 300, 304, 306, 308

inserts,
spring terminal connection

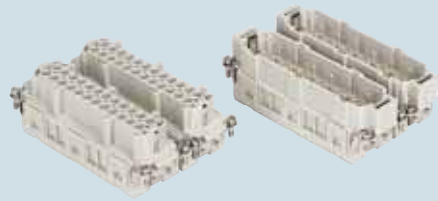

inserts, crimp connections
16A normal and for advanced opening
silver and gold plated contacts

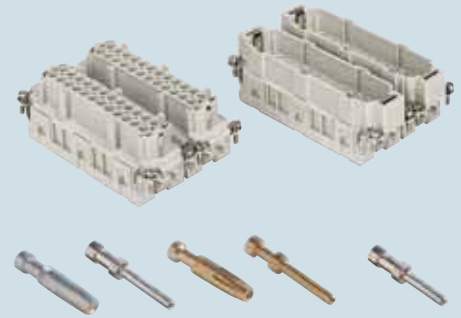

description	part No.	part No.	part No.	part No.
female inserts, No. (1÷24) and (25÷48) male inserts, No. (1÷24) and (25÷48)	CMSEF 10 CMSEM 10	CMSEF 10 N CMSEM 10 N		
without contacts (to be ordered separately) female inserts, No. (1÷24) and (25÷48) male inserts, No. (1÷24) and (25÷48)			CMCEF 10 CMCEM 10	CMCEF 10 N CMCEM 10 N
16A female contacts 0.5 mm ² AWG 20 with no grooves 0.75 mm ² AWG 18 one groove (back side) 1 mm ² AWG 18 one groove 1.5 mm ² AWG 16 two grooves 2.5 mm ² AWG 14 three grooves 3 mm ² AWG 12 one wide groove 4 mm ² AWG 12 with no grooves			CCFA 0.5 CCFA 0.7 CCFA 1.0 CCFA 1.5 CCFA 2.5 CCFA 3.0 CCFA 4.0	CCFD 0.5 CCFD 0.7 CCFD 1.0 CCFD 1.5 CCFD 2.5 CCFD 3.0 CCFD 4.0
16A male contacts 0.5 mm ² AWG 20 with no grooves 0.75 mm ² AWG 18 one groove (back side) 1 mm ² AWG 18 one groove 1.5 mm ² AWG 16 two grooves 2.5 mm ² AWG 14 three grooves 3 mm ² AWG 12 one wide groove 4 mm ² AWG 12 with no grooves			CCMA 0.5 CCMA 0.7 CCMA 1.0 CCMA 1.5 CCMA 2.5 CCMA 3.0 CCMA 4.0	CCMD 0.5 CCMD 0.7 CCMD 1.0 CCMD 1.5 CCMD 2.5 CCMD 3.0 CCMD 4.0
16A male crimp contacts for advanced opening 0.5 mm ² AWG 20 with no grooves 0.75 mm ² AWG 18 one groove (back side) 1 mm ² AWG 18 one groove 1.5 mm ² AWG 16 two grooves 2.5 mm ² AWG 14 three grooves			CC 0.5 AN CC 0.7 AN CC 1.0 AN CC 1.5 AN CC 2.5 AN	

silver plated

gold plated

dimensions of crimp contacts in mm
(for CMCE inserts)

CCF e CCM

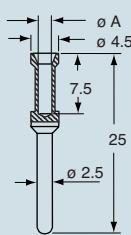

CC...AN

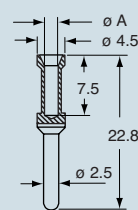

CCF, CCM and CC...AN contacts

conductor section mm ²	ø slot A (mm)
0.5	1.1
0.75	1.3
1.0	1.45
1.5	1.8
2.5	2.2
3	2.55
4	2.85

- stripping length see section feature of inserts on page 13

dimensions indicated are not binding
and may be changed without notice

dimensions in mm

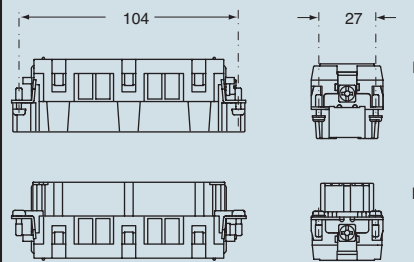

contacts side (front view)

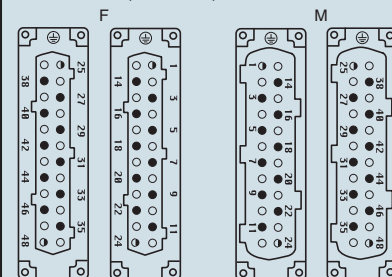

the auxiliary contacts are in the forward position upon opening

- inserts for section conductors:
0.14 ÷ 2.5 mm² - AWG 26 ÷ 14

- stripping length see section feature of inserts on page 13

dimensions in mm

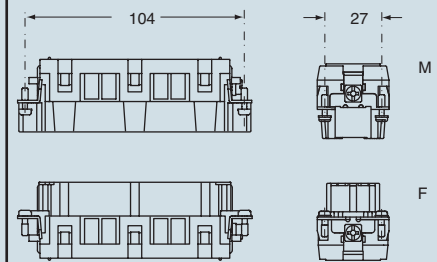

contacts side (front view)

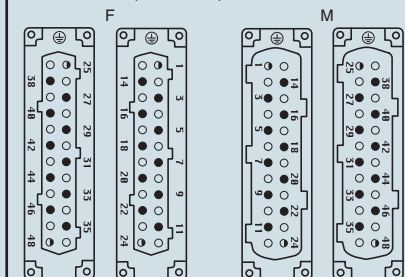

the auxiliary contacts are in the forward position upon opening

enclosures: **size "104.62"**

standard page: 232

aggressive environments page: 234

- features according to EN 61984:
- 16A 830V 8kV 3**
- auxiliary contacts: **16A 500V 6kV 3**
- certifications: UL, (CSA), CCC; the certifications shown in brackets are being applied for
- for maximum current load, see the insert load curve section on page 32

**inserts,
screw terminal connection**

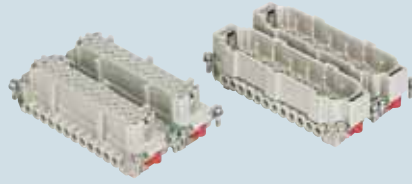

description	part No.	part No.
indirect, with plate 1) female inserts, No. (1÷24) and (25÷48) male inserts, No. (1÷24) and (25÷48)	CMEF 10 T CMEM 10 T	CMEF 10 TN CMEM 10 TN
direct, without plate 2) female inserts, No. (1÷24) and (25÷48) male inserts, No. (1÷24) and (25÷48)	CMEF 10 TX CMEM 10 TX	CMEF 10 TXN CMEM 10 TXN

- 1) for non-prepared conductors
- 2) for bush terminal conductors

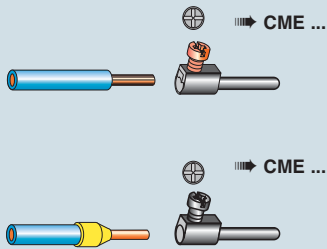

dimensions in mm

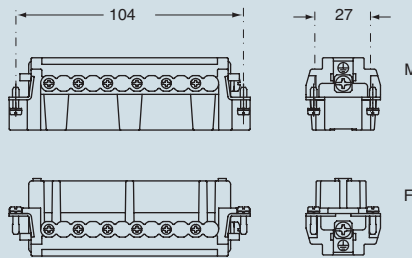

contacts side (front view)

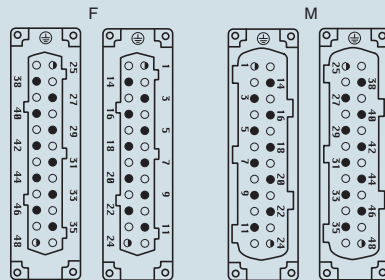

● the auxiliary contacts are in the forward position upon opening

- inserts with plate, for section conductors: 0.5 ÷ 2.5 mm² - AWG 20 ÷ 14
- inserts without plate, for section conductors: 0.25 ÷ 2.5 mm² - AWG 24 ÷ 14
- torsion couple recommended for conductor fastening screws and stripping length see section feature of inserts on page 13

dimensions indicated are not binding and may be changed without notice

enclosures: size "104.27"

insulated 830V page: 217 ÷ 221
 aggressive environments page: 223

panel supports:
 COB page: 258 ÷ 259

- features according to EN 61984:
- 16A 400/690V 6kV 3**
- auxiliary contacts: **16A 500V 6kV 3**
- certifications: UL, (CSA), CCC; the certifications shown in brackets are being applied for
- for maximum current load, see the insert load curve section on page 32
- inserts and enclosures for applications with temperatures up to 180 °C, available on request; enclosures on page 222
- for contact crimping, see the crimp tool section (16A, CCF and CCM series contacts) on pages 296, 300, 304, 306, 308

inserts,
 screw terminal connection



inserts, crimp connections
 16A silver and gold plated contacts

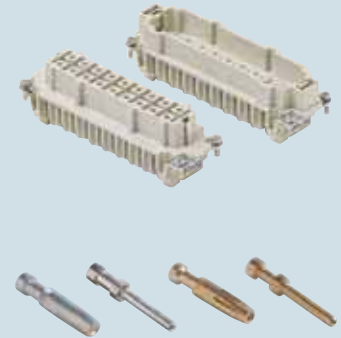

description	part No.	part No.	part No.																																										
female inserts with female contacts male inserts with male contacts	CMEF 16 CMEM 16																																												
without contacts (to be ordered separately) female inserts for female contacts male inserts for male contacts		CMCEF 16 CMCEM 16																																											
<p>16A female contacts</p> <table border="0"> <tr><td>0.5 mm²</td><td>AWG 20</td><td>with no grooves</td></tr> <tr><td>0.75 mm²</td><td>AWG 18</td><td>one groove (back side)</td></tr> <tr><td>1 mm²</td><td>AWG 18</td><td>one groove</td></tr> <tr><td>1.5 mm²</td><td>AWG 16</td><td>two grooves</td></tr> <tr><td>2.5 mm²</td><td>AWG 14</td><td>three grooves</td></tr> <tr><td>3 mm²</td><td>AWG 12</td><td>one wide groove</td></tr> <tr><td>4 mm²</td><td>AWG 12</td><td>with no grooves</td></tr> </table> <p>16A male contacts</p> <table border="0"> <tr><td>0.5 mm²</td><td>AWG 20</td><td>with no grooves</td></tr> <tr><td>0.75 mm²</td><td>AWG 18</td><td>one groove (back side)</td></tr> <tr><td>1 mm²</td><td>AWG 18</td><td>one groove</td></tr> <tr><td>1.5 mm²</td><td>AWG 16</td><td>two grooves</td></tr> <tr><td>2.5 mm²</td><td>AWG 14</td><td>three grooves</td></tr> <tr><td>3 mm²</td><td>AWG 12</td><td>one wide groove</td></tr> <tr><td>4 mm²</td><td>AWG 12</td><td>with no grooves</td></tr> </table>	0.5 mm ²	AWG 20	with no grooves	0.75 mm ²	AWG 18	one groove (back side)	1 mm ²	AWG 18	one groove	1.5 mm ²	AWG 16	two grooves	2.5 mm ²	AWG 14	three grooves	3 mm ²	AWG 12	one wide groove	4 mm ²	AWG 12	with no grooves	0.5 mm ²	AWG 20	with no grooves	0.75 mm ²	AWG 18	one groove (back side)	1 mm ²	AWG 18	one groove	1.5 mm ²	AWG 16	two grooves	2.5 mm ²	AWG 14	three grooves	3 mm ²	AWG 12	one wide groove	4 mm ²	AWG 12	with no grooves		<p>CCFA 0.5 CCFA 0.7 CCFA 1.0 CCFA 1.5 CCFA 2.5 CCFA 3.0 CCFA 4.0</p> <p style="writing-mode: vertical-rl; text-orientation: mixed;">silver plated</p>	<p>CCFD 0.5 CCFD 0.7 CCFD 1.0 CCFD 1.5 CCFD 2.5 CCFD 3.0 CCFD 4.0</p> <p style="writing-mode: vertical-rl; text-orientation: mixed;">gold plated</p> <p>CCMA 0.5 CCMA 0.7 CCMA 1.0 CCMA 1.5 CCMA 2.5 CCMA 3.0 CCMA 4.0</p> <p>CCMD 0.5 CCMD 0.7 CCMD 1.0 CCMD 1.5 CCMD 2.5 CCMD 3.0 CCMD 4.0</p>
0.5 mm ²	AWG 20	with no grooves																																											
0.75 mm ²	AWG 18	one groove (back side)																																											
1 mm ²	AWG 18	one groove																																											
1.5 mm ²	AWG 16	two grooves																																											
2.5 mm ²	AWG 14	three grooves																																											
3 mm ²	AWG 12	one wide groove																																											
4 mm ²	AWG 12	with no grooves																																											
0.5 mm ²	AWG 20	with no grooves																																											
0.75 mm ²	AWG 18	one groove (back side)																																											
1 mm ²	AWG 18	one groove																																											
1.5 mm ²	AWG 16	two grooves																																											
2.5 mm ²	AWG 14	three grooves																																											
3 mm ²	AWG 12	one wide groove																																											
4 mm ²	AWG 12	with no grooves																																											

dimensions of crimp contacts in mm
 (for CMCE inserts)

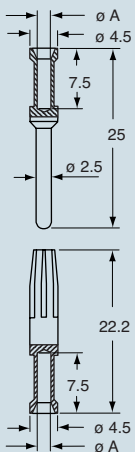

CCF and CCM contacts

conductor section mm ²	ø slot A (mm)
0.5	1.1
0.75	1.3
1.0	1.45
1.5	1.8
2.5	2.2
3	2.55
4	2.85

- stripping length see section feature of inserts on page 13

dimensions indicated are not binding and may be changed without notice

dimensions in mm

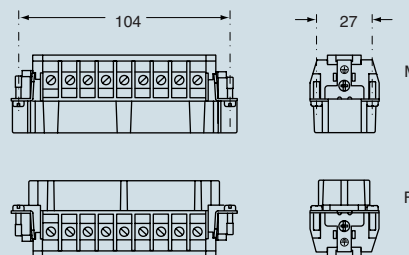

contacts side (front view)

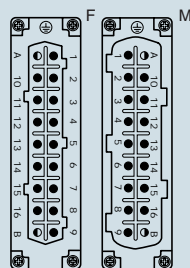

the auxiliary contacts are in the forward position upon opening

- inserts with plate, for section conductors: 0.75 ÷ 2.5 mm² - AWG 18 ÷ 14
- torsion couple recommended for conductor fastening screws and stripping length see section feature of inserts on page 13

dimensions in mm

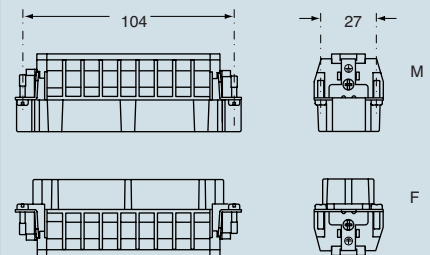

contacts side (front view)

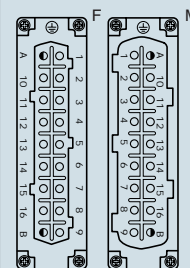

the auxiliary contacts are in the forward position upon opening

- the auxiliary contacts are the same as power contacts: early opening is obtained by drawing back the seats

enclosures: size "104.62"

standard page: 232
 aggressive environments page: 234

- features according to EN 61984: **16A 400/690V 6kV 3**
- auxiliary contacts: **16A 500V 6kV 3**
- certifications: UL, (CSA), CCC; the certifications shown in brackets are being applied for
- for maximum current load, see the insert load curve section on page 32
- inserts and enclosures for applications with temperatures up to 180 °C, available on request; enclosures on page 233
- for contact crimping, see the crimp tool section (16A, CCF and CCM series contacts) on pages 296, 300, 304, 306, 308

inserts,
screw terminal connection

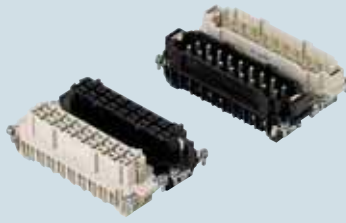

inserts, crimp connections
16A silver and gold plated contacts

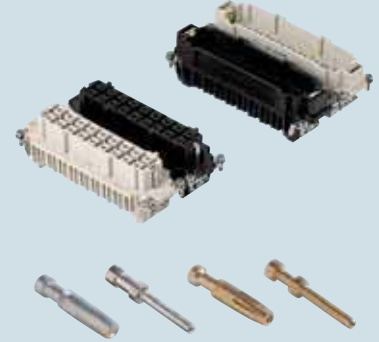

description	part No.	part No.	part No.	part No.
female inserts, white and black male inserts, white and black	CMEF 16 CMEM 16	CMEF 16 N CMEM 16 N		
without contacts (to be ordered separately) female inserts, white and black male inserts, white and black			CMCEF 16 CMCEM 16	CMCEF 16 N CMCEM 16 N
16A female contacts				
0.5 mm ² AWG 20 with no grooves			CCFA 0.5	CCFD 0.5
0.75 mm ² AWG 18 one groove (back side)			CCFA 0.7	CCFD 0.7
1 mm ² AWG 18 one groove			CCFA 1.0	CCFD 1.0
1.5 mm ² AWG 16 two grooves			CCFA 1.5	CCFD 1.5
2.5 mm ² AWG 14 three grooves			CCFA 2.5	CCFD 2.5
3 mm ² AWG 12 one wide groove			CCFA 3.0	CCFD 3.0
4 mm ² AWG 12 with no grooves			CCFA 4.0	CCFD 4.0
16A male contacts				
0.5 mm ² AWG 20 with no grooves			CCMA 0.5	CCMD 0.5
0.75 mm ² AWG 18 one groove (back side)			CCMA 0.7	CCMD 0.7
1 mm ² AWG 18 one groove			CCMA 1.0	CCMD 1.0
1.5 mm ² AWG 16 two grooves			CCMA 1.5	CCMD 1.5
2.5 mm ² AWG 14 three grooves			CCMA 2.5	CCMD 2.5
3 mm ² AWG 12 one wide groove			CCMA 3.0	CCMD 3.0
4 mm ² AWG 12 with no grooves			CCMA 4.0	CCMD 4.0

dimensions of crimp contacts in mm
(for CMCE inserts)

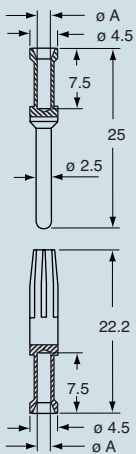

CCF and CCM contacts

conductor section mm ²	ø slot A (mm)
0.5	1.1
0.75	1.3
1.0	1.45
1.5	1.8
2.5	2.2
3	2.55
4	2.85

- stripping length see section feature of inserts on page 13

dimensions indicated are not binding and may be changed without notice

dimensions in mm

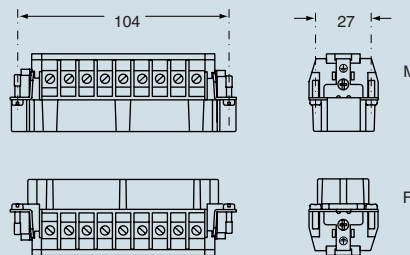

contacts side (front view)

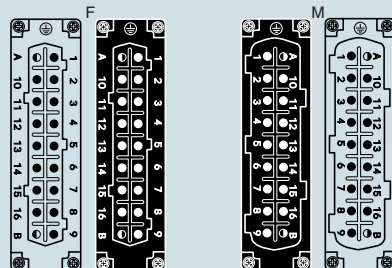

the auxiliary contacts are in the forward position upon opening

- inserts with plate, for section conductors: 0.75 ÷ 2.5 mm² - AWG 18 ÷ 14
- torsion couple recommended for conductor fastening screws and stripping length see section feature of inserts on page 13

dimensions in mm

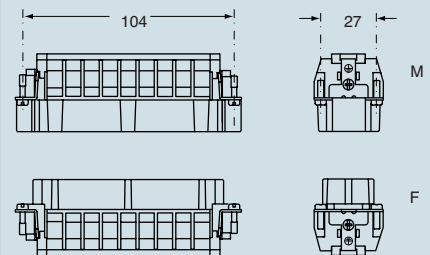

contacts side (front view)

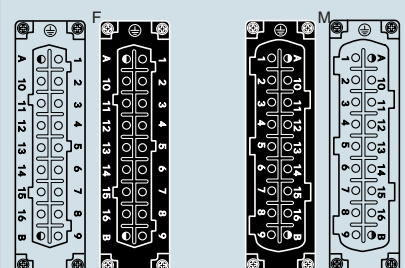

the auxiliary contacts are in the forward position upon opening

- the auxiliary contacts are the same as power contacts: early opening is obtained by drawing back the seats

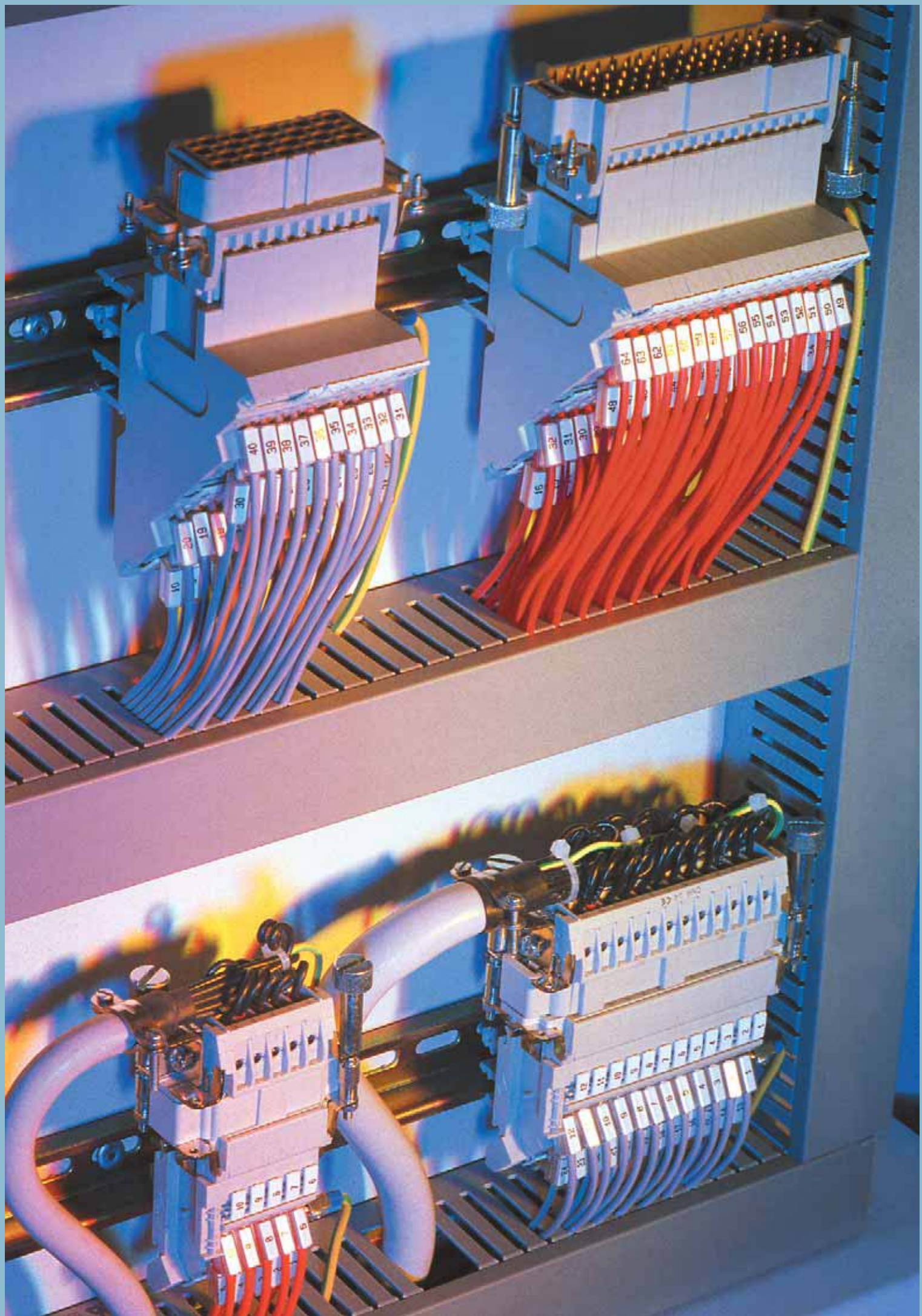

enclosures: **size "77.27"**

standard page: 198 ÷ 202
for 180 °C page: 208
aggressive environments page: 209
EMC page: 210

panel supports:

COB page: 258 ÷ 259

- features according to EN 61984:

35A 400/690V 6kV 3

- UL, CSA, CCC certified

- for maximum current load, see the insert load curve section on page 32

**inserts,
screw terminal connection**

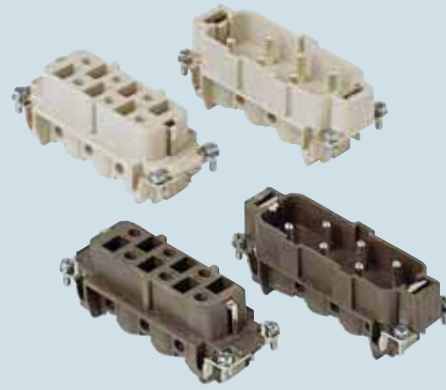

description	part No.
-------------	----------

indirect, with plate female inserts with female contacts male inserts with male contacts	CPF 06 CPM 06
--	--------------------------------

indirect, with plate, use in temperatures up to 180 °C female inserts with female contacts, brown male inserts with male contacts, brown	CPF 06 RY CPM 06 RY
--	--------------------------------------

dimensions in mm

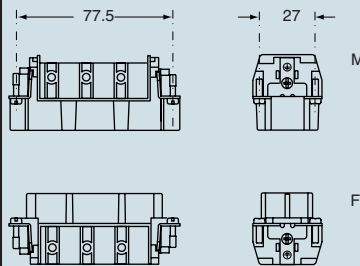

contacts side (front view)

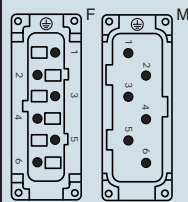

- inserts with plate, for section conductors:
1.50 ÷ 6 mm² - AWG 16 ÷ 10
- torsion couple recommended for conductor fastening screws and stripping length see section feature of inserts on page 13

dimensions indicated are not binding
and may be changed without notice

enclosures: size "77.62"

standard page: 226 ÷ 229

aggressive environments page: 230

- features according to EN 61984:

35A 400/690V 6kV 3

- UL, CSA, CCC certified

- for maximum current load, see the insert load curve section on page 32

**inserts,
screw terminal connection**

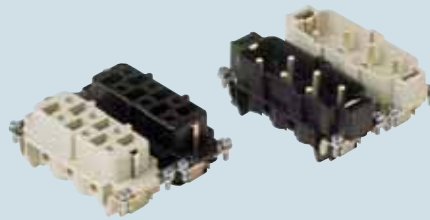

description	part No.	part No.
indirect, with plate female inserts No. (1÷6), white and black male inserts No. (1÷6), white and black	CPF 06 CPM 06	CPF 06 N CPM 06 N

dimensions in mm

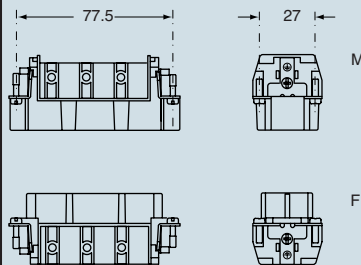

contacts side (front view)

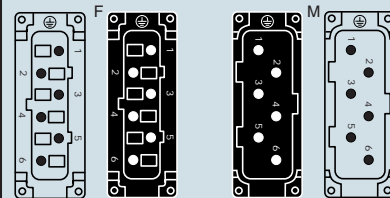

- inserts with plate, for section conductors:
1.50 ÷ 6 mm² - AWG 16 ÷ 10
- torsion couple recommended for conductor fastening
screws and stripping length see section feature of
inserts on page 13

dimensions indicated are not binding
and may be changed without notice

CP

enclosures: **size "57.27"**
standard page: 184 ÷ 188
aggressive environments page: 195
EMC page: 196

panel supports:
COB page: 258 ÷ 259

- features according to EN 61984:
16A 230/400V 4kV 3 (16A 400V 4kV 2)
10A 160V 2,5kV 3 (10A 250V 4kV 2)
- UL, CSA, CCC, GL certified
- for maximum current load, see the insert load curve section on page 33
- for contact crimping, see the crimp tool section (16A contacts CCF, CCM, CC...AN series and 10A contacts CDF, CDM series) on pages 296, 300, 304, 306, 308
- PCBs interface, see article CIF 2.4 (10A contacts)

**inserts,
crimp connections**



**16A and 10A crimp contacts
normal and for advanced opening
silver and gold plated**



description

without contacts (to be ordered separately)
 female inserts for female contacts
 male inserts for male contacts

part No.

CXF 8/24
CXM 8/24

part No. part No.

16A female contacts

0.5 mm ²	AWG 20	with no grooves
0.75 mm ²	AWG 18	one groove (back side)
1 mm ²	AWG 18	one groove
1.5 mm ²	AWG 16	two grooves
2.5 mm ²	AWG 14	three grooves
3 mm ²	AWG 12	one wide groove
4 mm ²	AWG 12	with no grooves

16A male contacts

0.5 mm ²	AWG 20	with no grooves
0.75 mm ²	AWG 18	one groove (back side)
1 mm ²	AWG 18	one groove
1.5 mm ²	AWG 16	two grooves
2.5 mm ²	AWG 14	three grooves
3 mm ²	AWG 12	one wide groove
4 mm ²	AWG 12	with no grooves

16A male crimp contacts for advanced opening

0.5 mm ²	AWG 20	with no grooves
0.75 mm ²	AWG 18	one groove (back side)
1 mm ²	AWG 18	one groove
1.5 mm ²	AWG 16	two grooves
2.5 mm ²	AWG 14	three grooves

10A female contacts

0.14÷0.37 mm ²	AWG 26÷22	identification No. 1
0.5 mm ²	AWG 20	identification No. 2
0.75 mm ²	AWG 18	identification No. ②
1 mm ²	AWG 18	identification No. ③
1.5 mm ²	AWG 16	identification No. 4
2.5 mm ²	AWG 14	identification No. 5

10A male contacts

0.14÷0.37 mm ²	AWG 26÷22	identification No. 1
0.5 mm ²	AWG 20	identification No. 2
0.75 mm ²	AWG 18	identification No. ②
1 mm ²	AWG 18	identification No. ③
1.5 mm ²	AWG 16	identification No. 4
2.5 mm ²	AWG 14	identification No. 5

CCFA 0.5
 CCFA 0.7
 CCFA 1.0
 CCFA 1.5
 CCFA 2.5
 CCFA 3.0
 CCFA 4.0

silver plated

CCFD 0.5
 CCFD 0.7
 CCFD 1.0
 CCFD 1.5
 CCFD 2.5
 CCFD 3.0
 CCFD 4.0

gold plated

CCMA 0.5
 CCMA 0.7
 CCMA 1.0
 CCMA 1.5
 CCMA 2.5
 CCMA 3.0
 CCMA 4.0

CCMD 0.5
 CCMD 0.7
 CCMD 1.0
 CCMD 1.5
 CCMD 2.5
 CCMD 3.0
 CCMD 4.0

CC 0.5 AN
 CC 0.7 AN
 CC 1.0 AN
 CC 1.5 AN
 CC 2.5 AN

CDFA 0.3
 CDFA 0.5
 CDFA 0.7
 CDFA 1.0
 CDFA 1.5
 CDFA 2.5

silver plated

CDFD 0.3
 CDFD 0.5
 CDFD 0.7
 CDFD 1.0
 CDFD 1.5
 CDFD 2.5

gold plated

CDMA 0.3
 CDMA 0.5
 CDMA 0.7
 CDMA 1.0
 CDMA 1.5
 CDMA 2.5

CDMD 0.3
 CDMD 0.5
 CDMD 0.7
 CDMD 1.0
 CDMD 1.5
 CDMD 2.5

CCF, CCM and CC...AN contacts

conductor section mm ²	ø slot A (mm)
0.5	1.1
0.75	1.3
1.0	1.45
1.5	1.8
2.5	2.2
3	2.55
4	2.85

CDF and CDM contacts

conductor section mm ²	conductor slot ø A (mm)	B (mm)
0.14÷0.37	0.9	8
0.5	1.1	8
0.75	1.3	8
1.0	1.45	8
1.5	1.8	8
2.5	2.2	6

- stripping length see section feature of inserts on page 13

dimensions indicated are not binding and may be changed without notice

dimensions in mm

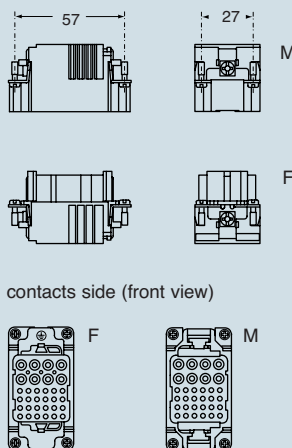

dimensions in mm

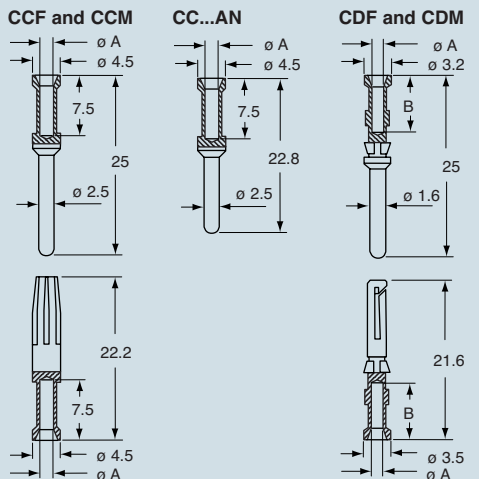

enclosures: **size "77.27"**
standard page: 198 ÷ 202
aggressive environments page: 209
EMC page: 210

panel supports:
COB page: 258 ÷ 259

- features according to EN 61984:
40A 690V 8kV 3
10A 160V 2,5kV 3
- UL, CSA, CCC, GL certified
- for maximum current load, see the insert load curve section on page 33
- for contact crimping instructions, please see the crimping tool section (40A contacts CXF, CXM series and 10A contacts CDF, CDM series) on pages 296, 298, 300, 304, 306, 308
- PCBs interface, see article CIF 2.4 (10A contacts)

**inserts,
crimp connections**

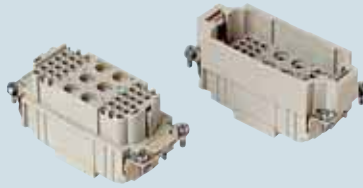

**40A and 10A crimp contacts
silver and gold plated**



description	part No.	part No.	part No.
without contacts (to be ordered separately) female inserts for female contacts male inserts for male contacts	CXF 6/36 CXM 6/36		
40A female contacts 1.5 mm ² AWG 16 2.5 mm ² AWG 14 4 mm ² AWG 12 6 mm ² AWG 10		CXFA 1.5 CXFA 2.5 CXFA 4.0 CXFA 6.0	silver plated
40A male contacts 1.5 mm ² AWG 16 2.5 mm ² AWG 14 4 mm ² AWG 12 6 mm ² AWG 10		CXMA 1.5 CXMA 2.5 CXMA 4.0 CXMA 6.0	silver plated
10A female contacts 0.14+0.37 mm ² AWG 26÷22 identification No. 1 0.5 mm ² AWG 20 identification No. 2 0.75 mm ² AWG 18 identification No. ② 1 mm ² AWG 18 identification No. 3 1.5 mm ² AWG 16 identification No. 4 2.5 mm ² AWG 14 identification No. 5		CDFA 0.3 CDFA 0.5 CDFA 0.7 CDFA 1.0 CDFA 1.5 CDFA 2.5	silver plated
10A male contacts 0.14+0.37 mm ² AWG 26÷22 identification No. 1 0.5 mm ² AWG 20 identification No. 2 0.75 mm ² AWG 18 identification No. ② 1 mm ² AWG 18 identification No. 3 1.5 mm ² AWG 16 identification No. 4 2.5 mm ² AWG 14 identification No. 5		CDMA 0.3 CDMA 0.5 CDMA 0.7 CDMA 1.0 CDMA 1.5 CDMA 2.5	gold plated
		CDFD 0.3 CDFD 0.5 CDFD 0.7 CDFD 1.0 CDFD 1.5 CDFD 2.5	gold plated
		CDMD 0.3 CDMD 0.5 CDMD 0.7 CDMD 1.0 CDMD 1.5 CDMD 2.5	gold plated

CXF and CXM contacts

conductor section mm ²	conductor slot	
	ø A (mm)	B (mm)
1.5	1.8	9
2.5	2.2	9
4	2.85	9.6
6	3.5	9.6

CDF and CDM contacts

conductor section mm ²	conductor slot	
	ø A (mm)	B (mm)
0.14+0.37	0.9	8
0.5	1.1	8
0.75	1.3	8
1.0	1.45	8
1.5	1.8	8
2.5	2.2	6

- stripping length see section feature of inserts on page 13

dimensions in mm

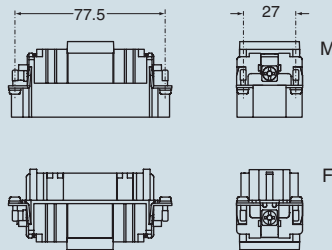

contacts side (front view)

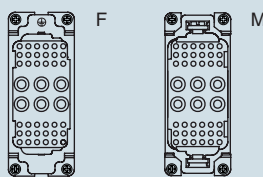

dimensions in mm

CXF and CXM **CDF and CDM**

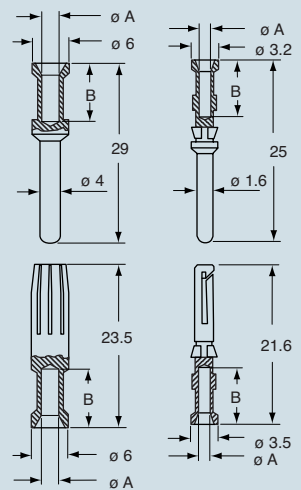

dimensions indicated are not binding and may be changed without notice

enclosures: size "77.27"

standard page: 198 ÷ 202
aggressive environments page: 209
EMC page: 210

panel supports:
COB page: 258 ÷ 259

- features according to EN 61984:
40A 690V 8kV 3
10A 250V 4kV 3
- UL, CSA, CCC, GL certified
- for maximum current load, see the insert load curve section on page 33
- for contact crimping instructions, please see the crimping tool section (40A contacts CXF, CXM series and 10A contacts CDF, CDM series) on pages 296, 298, 300, 304, 306, 308

**inserts,
crimp connections**

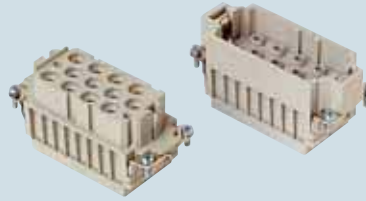

**40A and 10A crimp contacts
silver and gold plated**



description	part No.	part No.	part No.
without contacts (to be ordered separately) female inserts for female contacts male inserts for male contacts	CXF 12/2 CXM 12/2		
40A female contacts 1.5 mm ² AWG 16 2.5 mm ² AWG 14 4 mm ² AWG 12 6 mm ² AWG 10 40A male contacts 1.5 mm ² AWG 16 2.5 mm ² AWG 14 4 mm ² AWG 12 6 mm ² AWG 10		silver plated	CXFA 1.5 CXFA 2.5 CXFA 4.0 CXFA 6.0 CXMA 1.5 CXMA 2.5 CXMA 4.0 CXMA 6.0
10A female contacts 0.14÷0.37 mm ² AWG 26÷22 identification No. 1 0.5 mm ² AWG 20 identification No. 2 0.75 mm ² AWG 18 identification No. ② 1 mm ² AWG 18 identification No. 3 1.5 mm ² AWG 16 identification No. 4 2.5 mm ² AWG 14 identification No. 5 10A male contacts 0.14÷0.37 mm ² AWG 26÷22 identification No. 1 0.5 mm ² AWG 20 identification No. 2 0.75 mm ² AWG 18 identification No. ② 1 mm ² AWG 18 identification No. 3 1.5 mm ² AWG 16 identification No. 4 2.5 mm ² AWG 14 identification No. 5		silver plated	CDFA 0.3 CDFD 0.3 CDFA 0.5 CDFD 0.5 CDFA 0.7 CDFD 0.7 CDFA 1.0 CDFD 1.0 CDFA 1.5 CDFD 1.5 CDFA 2.5 CDFD 2.5 CDMA 0.3 CDMD 0.3 CDMA 0.5 CDMD 0.5 CDMA 0.7 CDMD 0.7 CDMA 1.0 CDMD 1.0 CDMA 1.5 CDMD 1.5 CDMA 2.5 CDMD 2.5

CXF and CXM contacts

conductor section mm ²	conductor slot	
	ø A (mm)	B (mm)
1.5	1.8	9
2.5	2.2	9
4	2.85	9.6
6	3.5	9.6

CDF and CDM contacts

conductor section mm ²	conductor slot	
	ø A (mm)	B (mm)
0.14÷0.37	0.9	8
0.5	1.1	8
0.75	1.3	8
1.0	1.45	8
1.5	1.8	8
2.5	2.2	6

- stripping length see section feature of inserts on page 13

dimensions in mm

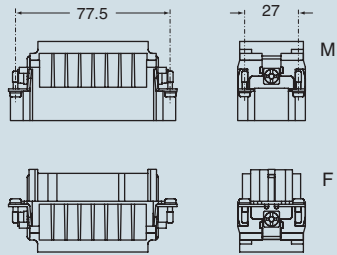

contacts side (front view)

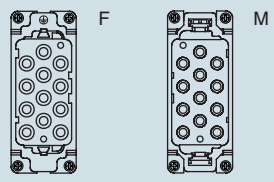

dimensions in mm

CXF and CXM CDF and CDM

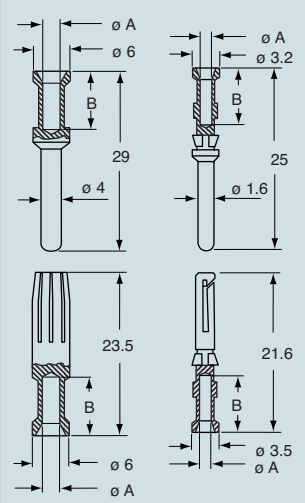

dimensions indicated are not binding and may be changed without notice

enclosures: **size "77.27"**

standard page: 198 ÷ 202
aggressive environments page: 209
EMC page: 210

panel supports:
COB page: 258 ÷ 259

- features according to EN 61984:
80A 690V 8kV 3
16A 400V 6kV 3
- UL, CSA, CCC, GL certified
- for maximum current load, see the insert load curve section on page 33
- inserts and enclosures for applications with temperatures up to 180 °C, available on request

**inserts,
screw terminal connection**

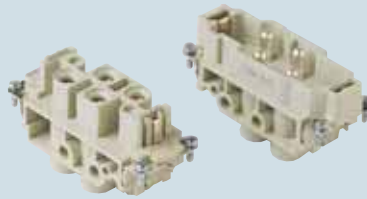

**inserts,
screw terminal connection**



description	part No.	part No.
female inserts with female contacts male inserts with male contacts	CXF 4/0 CXM 4/0	
female inserts with female contacts male inserts with male contacts		CXF 4/2 CXM 4/2

dimensions in mm

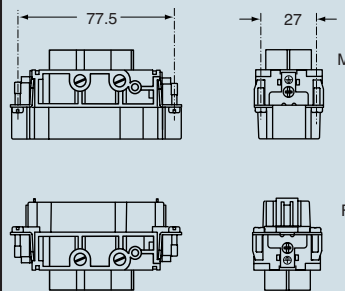

dimensions in mm

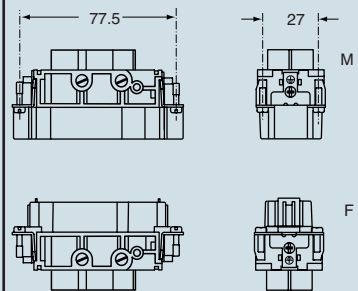

contacts side (front view)

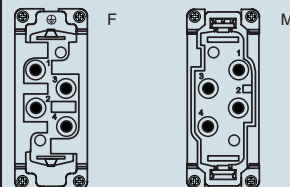

contacts side (front view)

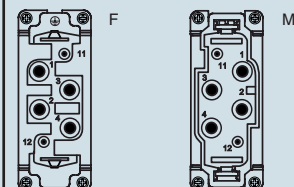

80A contacts

- without plate for section conductors:
 $4 \div 16 \text{ mm}^2$ - AWG 12 ÷ 6
- torsion couple recommended for conductor fastening screws and stripping length see section feature of inserts on page 13

80A contacts

- without plate for section conductors:
 $4 \div 16 \text{ mm}^2$ - AWG 12 ÷ 6
- torsion couple recommended for conductor fastening screws and stripping length see section feature of inserts on page 13

16A contacts

- without plate for section conductors:
 $0.25 \div 2.5 \text{ mm}^2$ - AWG 24 ÷ 14
- torsion couple recommended for conductor fastening screws and stripping length see section feature of inserts on page 13

dimensions indicated are not binding and may be changed without notice

enclosures: **size "104.27"**

standard page: 212 ÷ 216
aggressive environments page: 223
EMC page: 224

panel supports:

COB page: 258 ÷ 259

- features according to EN 61984:

80A 400V 6kV 3
16A 230/400V 4kV 3

- UL, CSA, CCC, GL certified
- for maximum current load, see the insert load curve section on page 34
- inserts and enclosures for applications with temperatures up to 180 °C, available on request

**inserts,
screw terminal connection**



description	part No.
female inserts with female contacts	CXF 4/8
male inserts with male contacts	CXM 4/8

dimensions in mm

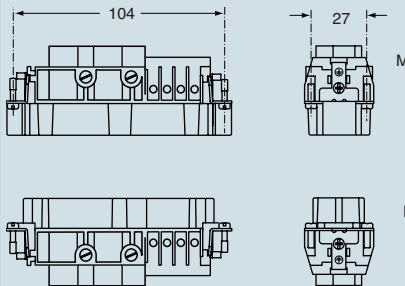

contacts side (front view)

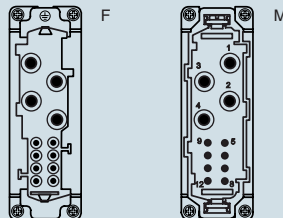

80A contacts

- without plate for section conductors:
4 ÷ 16 mm² - AWG 12 ÷ 6
- torsion couple recommended for conductor fastening screws and stripping length see section feature of inserts on page 13

16A contacts

- with plate for section conductors:
0.75 ÷ 2.5 mm² - AWG 18 ÷ 14
- torsion couple recommended for conductor fastening screws and stripping length see section feature of inserts on page 13

dimensions indicated are not binding and may be changed without notice

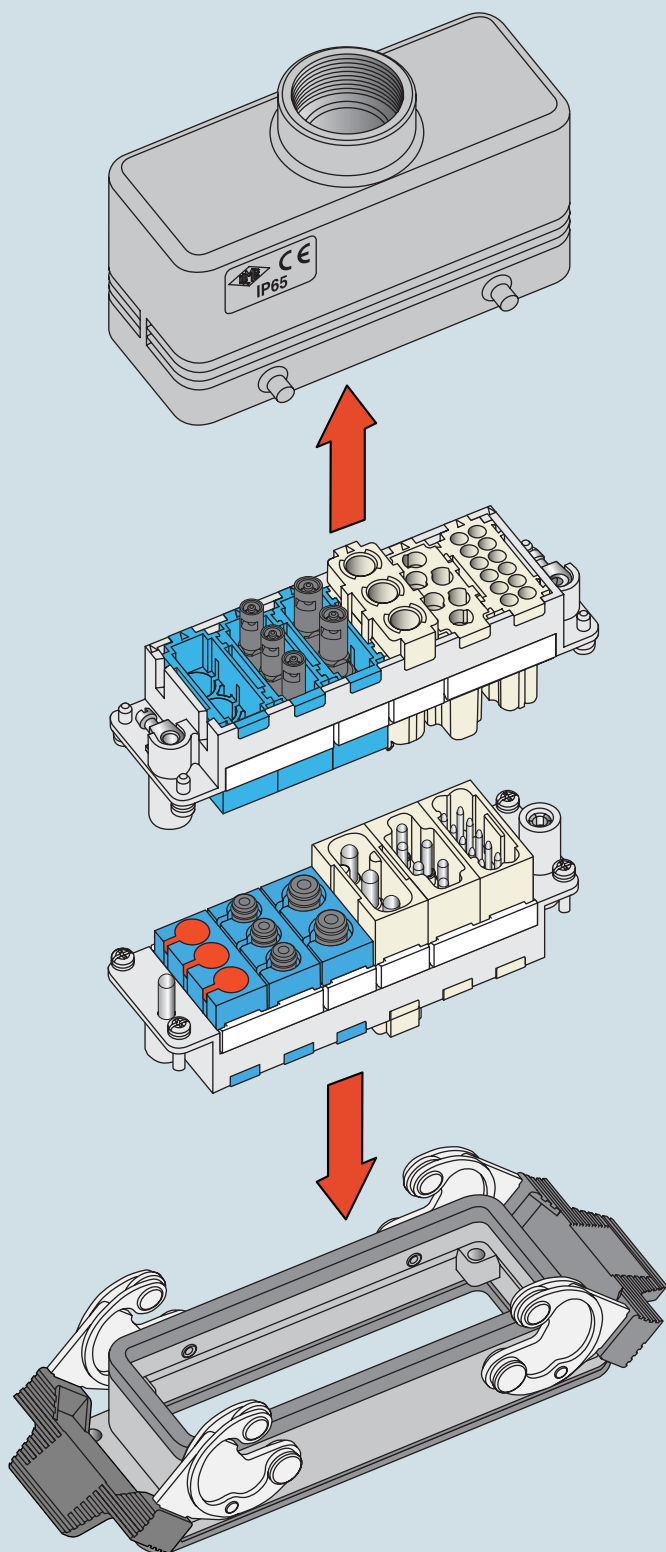

Use

The MIXO series is a system of modular units for special applications that uses the traditional ILME enclosures.

Each enclosure can house different types of connections such as, for example: electric signals and contacts for the conduction of compressed air and liquids with pressure values of up to 8 bars.

The inserts are arranged side by side to form a single compact block which is inserted into metallic frames with mandatory housings. Once the modules have been inserted and locked with the special tabs, the connector can then be inserted into the enclosure.

The modular structure system makes it easy to access a series of contacts inserted in the frame (e.g., for substitution, checks or the addition of signals with new inserts for needs not foreseen during the initial installation) without having to disassemble the entire connector.

The use of standard die-cast aluminium enclosures with degree of protection IP65 provides the possibility of innumerable applications.

The MIXO series may be used with 5 different frame sizes. The following table lists the frames and the metallic enclosures that may be used.

frames	one or two-level metallic enclosures
CX 01 T	size "49.16"
CX 02 TM/TF	size "44.27"
CX 03 TM/TF	size "57.27"
CX 04 TM/TF	size "77.27"
CX 06 TM/TF	size "104.27"
CX 04 TM/TF (x 2)	size "77.62"
CX 06 TM/TF (x 2)	size "104.62"

In addition, the MIXO series can be used with the COB series panel supports

frames	panel supports part No.
CX 02 TM/TF	fixed: COB 06 BC and COB TCQ
	mobile: COB TSF , COB TSFS and COB 06 CMS
CX 03 TM/TF	fixed: COB 10 BC and COB TCQ
	mobile: COB TSF , COB TSFS and COB 10 CMS
CX 04 TM/TF	fixed: COB 16 BC and COB TCQ
	mobile: COB TSF , COB TSFS and COB 16 CMS
CX 06 TM/TF	fixed: COB 24 BC and COB TCQ
	mobile: COB TSF , COB TSFS and COB 24 CMS

The MIXO series currently includes 6 different types of inserts. The field of application is provided in the table at the bottom of the next page.

Characteristics

- 1 electric contacts in silver-plated or gold-plated brass with connections to the conductors via crimping.
- 2 pneumatic contacts in plastic with insertion tube connection
- 3 modular inserts of identical size with insertion system for forming the complete module and frame lock tab.
- 4 inserts in self-extinguishing thermoplastic material, reinforced with glass fibre, UL 94-V0 approved, with a working temperature range of -40 °C to +125 °C.
- 5 inserts in conformance with the requirements of the EN 61984 standard and certified and marked with the UL, CSA, CCC, GL marks.
- 6 inserts with asymmetric guide rails to prevent incorrect coupling.
- 7 position of contacts identified with numbers or codes on both sides of every insert.
- 8 male/female module carrier frames with mandatory housings and polarity, in die-cast zinc alloy.
- 9 module lock tab, may be divided according to the number of modules used; guarantees a perfect stability of the modules during wiring and coupling/uncoupling of the connectors.
- 10 asymmetric earth contacts (two for frame) with wide contact surface prevent incorrect coupling; when two or more identical connectors of the MIXO series are used, coded pins prevent incorrect coupling (see pages 269, 270 and 271).
- 11 captive frame fastening screws, with flexible spring washer.
- 12 dummy module for unused frame slots.

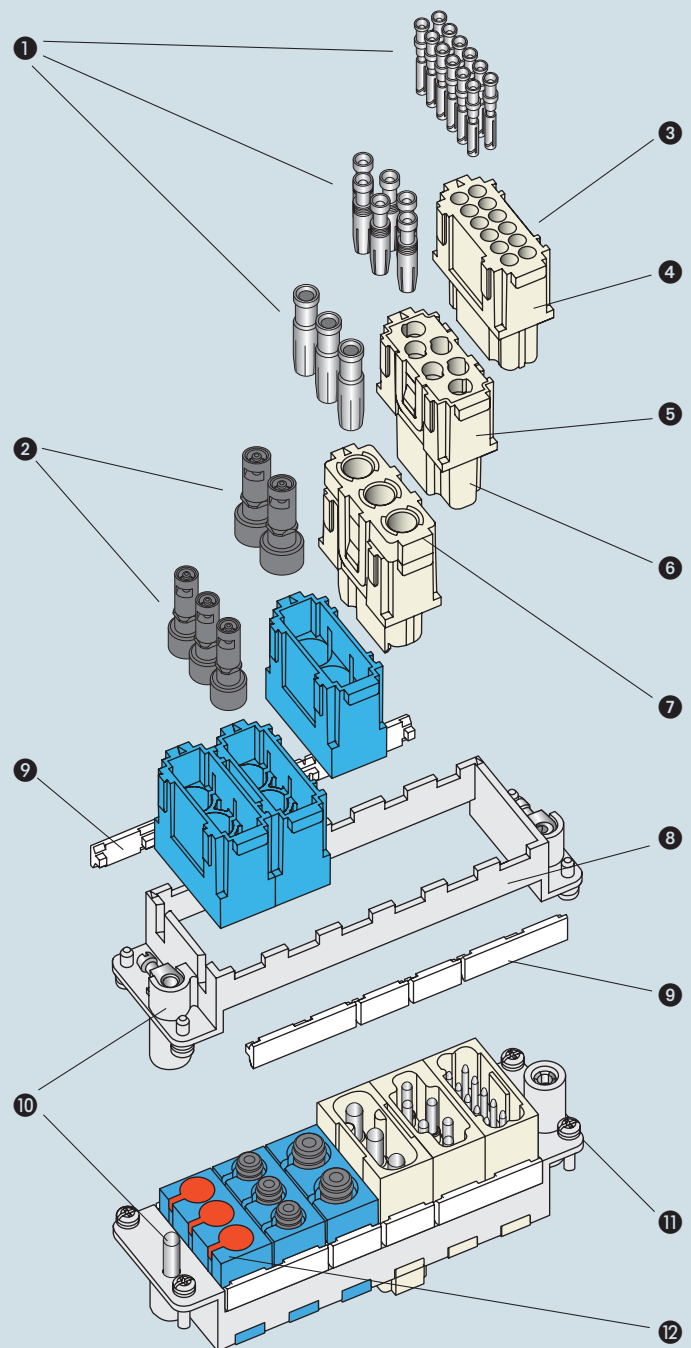

inserts	contact type	signal type	connectors and tubes connections	rated current A max	rated voltage V	No. of modules footprint
CX 02 GF/M	main	electric	crimp	100	1000	2
CX 02 4AF/M	main	electric	axial screw	40	1000	1
CX 03 4F/M	main	electric	crimp	40	400/690	1
CX 05 SF/M	main	electric	spring	16	400	1
CX 06 CF/M	main	electric	crimp	16	500	1
CX 08 CF/M	main	electric	crimp	16	400	1
CX 20 CF/M	main	electric	crimp	16	500	2
CX 12 DF/M	main / auxiliary	electric	crimp	10	250	1
CX 02 HF/M	main	electric	crimp	16	2900/5000	2
CX 02 BF/M	multiaxial connectors	see CX 04 B	---	---	---	2
CX 01 BF/M	main / auxiliary + shield	electric	crimp	10	50	---
CX 04 BF/M	main / auxiliary + shield	electric	crimp	10	50	---
CX 03 P	pneumatic Ø 1.6 - 3.0 - 4.0 mm	gas / liquid **	insertion	---	---	1
CX 02 P	pneumatic Ø 6.0 mm	gas / liquid **	insertion	---	---	1
CX FM	none (dummy module)	---	---	---	---	1
CX 01 JF	RJ45 + auxiliary	electric	crimp	---	---	2
CX 02 JF	RJ45 + auxiliary	electric	crimp	---	---	3

** **Warning:** For obvious reasons of safety, the VDE standard does not permit electric contacts to be present within the same connector group together with contacts for the transmission of liquids. In addition, the use of pneumatic air contacts requires an appropriate filtering and dehydration system to prevent dangerous condensation. Contacts may be used for pressure values of up to a maximum of 8 bar/116 psi.

MIXO CX..G 100A version modular inserts.

The MIXO series has been enhanced with a **new insert, suitable for currents up to 100A** and with **new, CG series crimp contacts** featuring several benefits over conventional screw contacts as they are:

- More **resistant to mechanical stresses** such as vibrations and cable loads
- More **corrosion resistant** (gas tight)
- **Quicker to connect** and ensuring more **consistent results** (regardless of the operators "force")
- The connector is **electrically more efficient** (reduced voltage drop)

This innovative insert design, **patented by ILME**, ensures a quicker fitting and removal of crimped contacts.

The plates provided firmly fasten the contact holder and, once the insert is mated to other inserts and is inserted in the MIXO frame, the connection is totally secure and **extremely resistant, even to the most severe stresses** such as vibrations.

The contacts can be removed **without having to use any special tools** but by simply using a screwdriver.

The crimping operation can be carried out quickly and effectively thanks to the CGPZ **hydraulically operated pliers provided** which, on request, can be supplied with the required locator and dies.

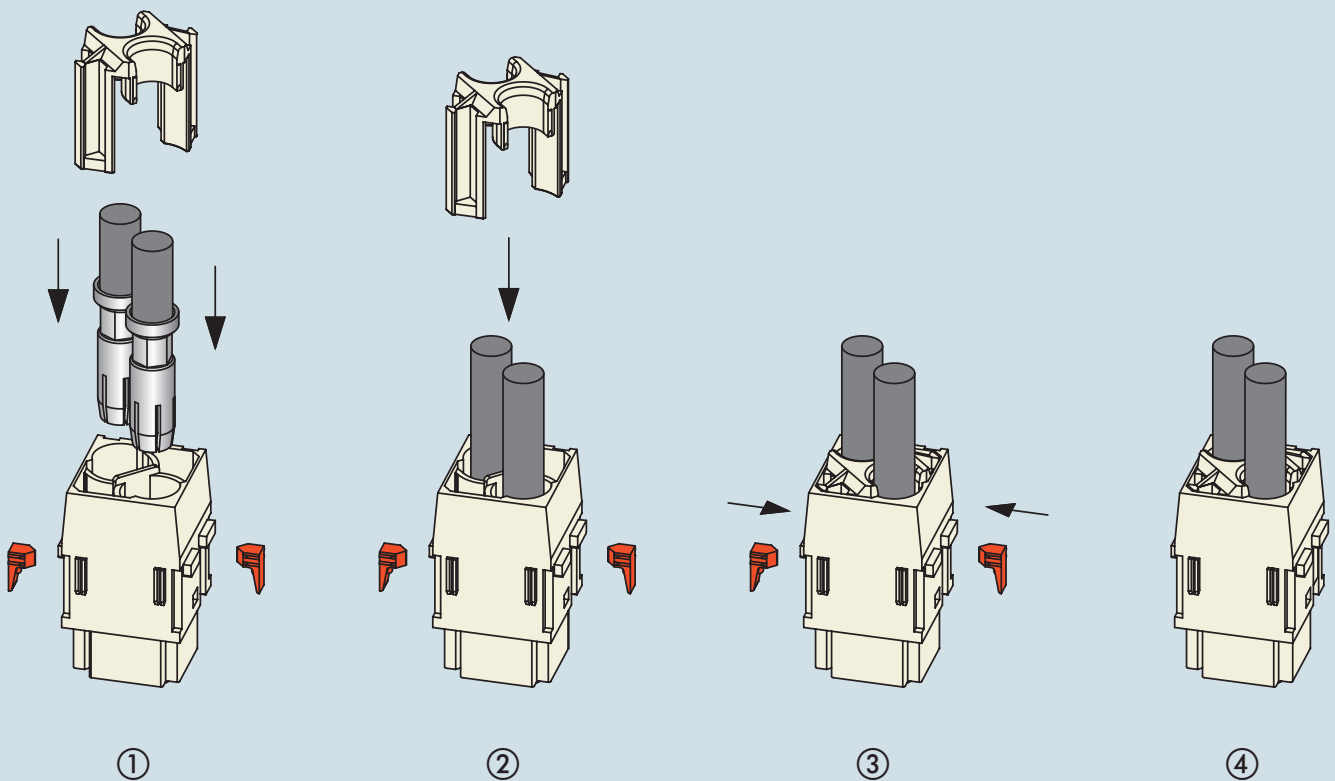

the modular inserts must be installed in suitable frames which in turn are installed in traditional housings * or COB panel support

frames for modular units * page: 151

* usable enclosures: flush mounting or portable high

- features according to EN 61984:

100A 1000V 8kV 3

- certifications: cUL for USA and Canada, CCC, GL
- for maximum current load, see the insert load curve section on page 34

** on request, version with pole 3/4 numbering, references: **CX 02 GFN, CX 02 GMN**

modular units,
crimp connections adaptor

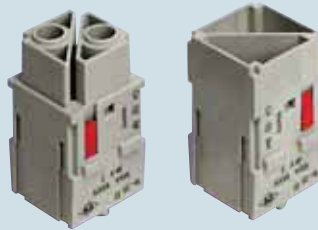

NEW

100A silver plated crimp contacts,
PE adapter



description	part No.	part No.
without contacts (to be ordered separately) - female inserts for female contacts ** - male inserts for female contacts **	CX 02 GF CX 02 GM	
100A female crimp contacts 16 mm ² AWG 6 - 5 25 mm ² AWG 4 - 3 35 mm ² AWG 2		CGFA 16 CGFA 25 CGFA 35
100A male crimp contacts 16 mm ² AWG 6 - 5 25 mm ² AWG 4 - 3 35 mm ² AWG 2		CGMA 16 CGMA 25 CGMA 35
cable earthing adaptor 16 mm ² (AWG 6 - 5)		CGT 16

silver plated

MIXO

How to use the PE adapter:

- 1) Strip 15 mm of flexible PE protective cable
- 2) Crimp the cable on the CGT 16 adapter by using the CGPZ pliers with the CGD 16 C matrix
- 3) Fix the adapter tip in the larger earth terminal (6 mm²) of frames CX...TM/TF

dimensions in mm



contacts side (front view)

side with reference arrow ▲

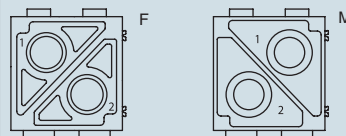

- footprint 2 modules

dimensions in mm

CGF and CGM

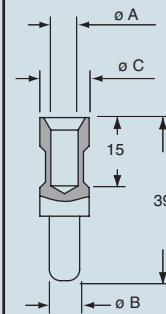

CGT 16

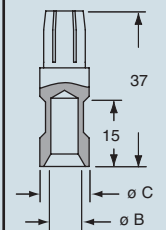
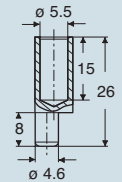

CGF and CGM contacts

conductor section mm ²	ø slot A (mm)	ø slot B (mm)	ø slot C (mm)
16	5.5	5.5	13
25	7.0	7.0	13
35	7.9	8.2	12.5

- stripping length see section feature of inserts on page 13

the modular inserts must be installed in suitable frames which in turn are installed in traditional housings or COB panel support

frames for modular units..... page: 151

- features according to EN 61984: **40A 1000V 8kV 3**
- certifications: (UL), (CSA); the certifications shown in brackets are being applied for
- for maximum current load, see the insert load curve section on page 34

modular units,
screw terminal connection



NEW

modular units,
screw terminal connection



NEW

description

- female inserts with female contacts
- male inserts with female contacts

- female inserts with female contacts
- male inserts with female contacts

- use flexible cables with sections from 2.5 to 10 mm² or extra flexible cables with sections from 2.5 to 6 mm²
- do not twist the cables
- fully insert the braids in the rear section of the contact

section (mm ²)	stripping length (mm)	tightening torque (Nm)
2.5	5+1	1.5
4	5+1	1.5
6	8+1	2
10	8+1	2

- insert a 2 mm hexagonal key in the front section of the contact and tighten by keeping the cable held down in position
- a 2 mm hexagonal key can be supplied on request, reference **CX AS**



part No.

CX 02 4AF
CX 02 4AM

dimensions in mm

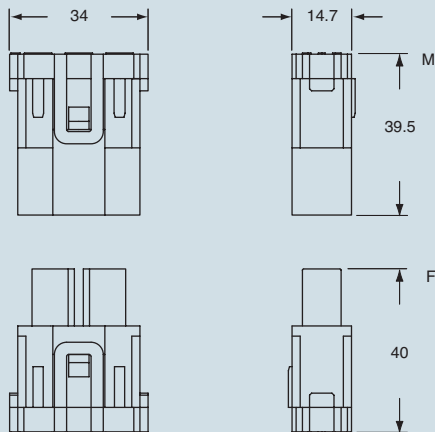

contacts side (front view)

side with reference arrow ▲

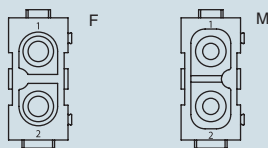

- inserts for Ø 4mm cables, section: 2.5÷8 mm² - AWG 14÷8
- footprint 1 module

part No.

CX 02 4BF
CX 02 4BM

dimensions in mm

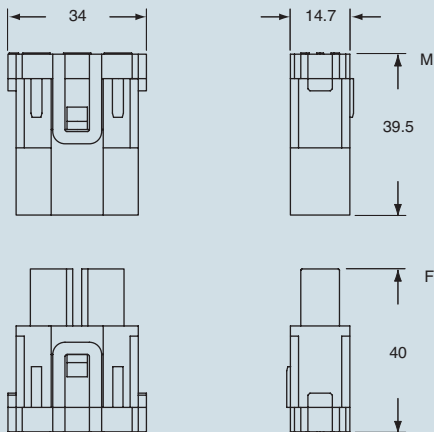

contacts side (front view)

side with reference arrow ▲

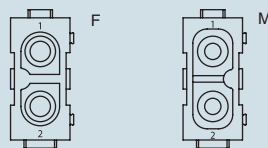

- inserts for Ø 4.8 mm cables, section: 6÷10 mm² - AWG 10÷8
- footprint 1 module

dimensions indicated are not binding and may be changed without notice

MIXO

the modular inserts must be installed in suitable frames which in turn are installed in traditional housings or COB panel support

frames for modular units page: 151

- features according to EN 61984:
- 40A 400/690V 6kV 3**
- UL, CSA, CCC, GL certified
- for maximum current load, see the insert load curve section on page 34
- for contact crimping instructions, please see the crimping tool section (40A contacts, CXF and CXM series) on pages 298, 300

modular units,
crimp connections

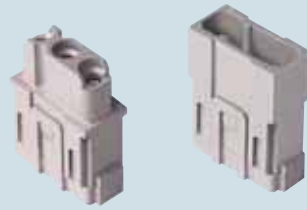

40A crimp contacts
silver plated



description

part No.

part No.

without contacts (to be ordered separately)
- female inserts for female contacts
- male inserts for female contacts

CX 03 4F
CX 03 4M

40A female crimp contacts

- 1.5 mm² AWG 16
- 2.5 mm² AWG 14
- 4 mm² AWG 12
- 6 mm² AWG 10

40A male crimp contacts

- 1.5 mm² AWG 16
- 2.5 mm² AWG 14
- 4 mm² AWG 12
- 6 mm² AWG 10

- CXFA 1.5**
- CXFA 2.5**
- CXFA 4.0**
- CXFA 6.0**

silver plated

- CXMA 1.5**
- CXMA 2.5**
- CXMA 4.0**
- CXMA 6.0**

dimensions in mm

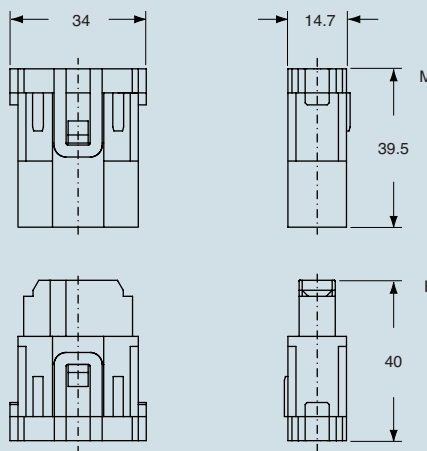

contacts side (front view)

side with reference arrow ▲

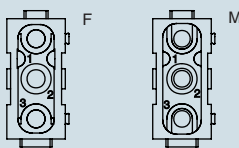

- footprint 1 module

dimensions in mm

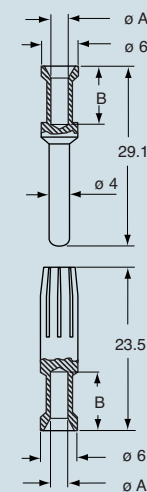

CXF and CXM contacts

conductor section mm ²	conductor slot	
	σA (mm)	B (mm)
1.5	1.8	9
2.5	2.2	9
4	2.85	9.6
6	3.5	9.6

- stripping length see section feature of inserts on page 13

dimensions indicated are not binding and may be changed without notice

the modular inserts must be installed in suitable frames which in turn are installed in traditional housings or COB panel support

frames for modular units..... page: 151

- features according to EN 61984:
- 16A 500V 6kV 3**
- UL, CSA, CCC, GL certified
- for maximum current load, see the insert load curve section on page 34
- for contact crimping instructions, please see the crimping tool section (16A contacts, CCF, CCM and CC...AN series) on page 296, 300, 304, 306, 308

modular units, crimp connections



16A crimp contacts normal or for advanced opening silver and gold plated



description	part No.	part No.	part No.
without contacts (to be ordered separately) - female inserts for female contacts - male inserts for female contacts	CX 06 CF CX 06 CM		
16A female crimp contacts 0.5 mm ² AWG 20 with no grooves 0.75 mm ² AWG 18 one groove (back side) 1 mm ² AWG 18 one groove 1.5 mm ² AWG 16 two grooves 2.5 mm ² AWG 14 three grooves 3 mm ² AWG 12 one wide groove 4 mm ² AWG 12 with no grooves		CCFA 0.5 CCFA 0.7 CCFA 1.0 CCFA 1.5 CCFA 2.5 CCFA 3.0 CCFA 4.0	CCFD 0.5 CCFD 0.7 CCFD 1.0 CCFD 1.5 CCFD 2.5 CCFD 3.0 CCFD 4.0
16A male crimp contacts 0.5 mm ² AWG 20 with no grooves 0.75 mm ² AWG 18 one groove (back side) 1 mm ² AWG 18 one groove 1.5 mm ² AWG 16 two grooves 2.5 mm ² AWG 14 three grooves 3 mm ² AWG 12 one wide groove 4 mm ² AWG 12 with no grooves		CCMA 0.5 CCMA 0.7 CCMA 1.0 CCMA 1.5 CCMA 2.5 CCMA 3.0 CCMA 4.0	CCMD 0.5 CCMD 0.7 CCMD 1.0 CCMD 1.5 CCMD 2.5 CCMD 3.0 CCMD 4.0
16A male crimp contacts for advanced opening 0.5 mm ² AWG 20 with no grooves 0.75 mm ² AWG 18 one groove (back side) 1 mm ² AWG 18 one groove 1.5 mm ² AWG 16 two grooves 2.5 mm ² AWG 14 three grooves		CC 0.5 AN CC 0.7 AN CC 1.0 AN CC 1.5 AN CC 2.5 AN	

silver plated

gold plated

dimensions in mm

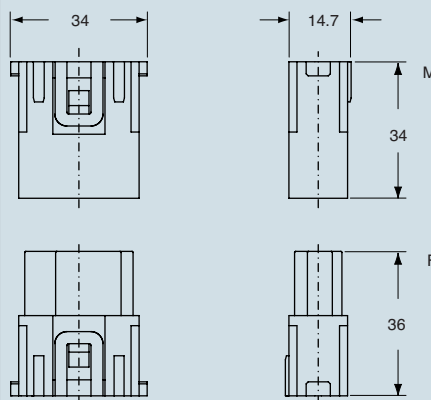

contacts side (front view)

side with reference arrow ▲

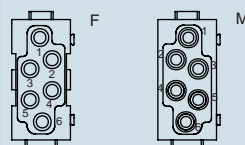

- footprint 1 module

dimensions in mm

CCF and CCM

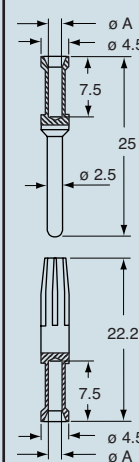

CC...AN

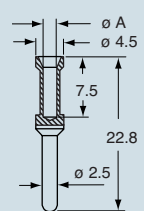

CCF, CCM and CC...AN contacts

conductor section mm ²	ø slot A (mm)
0.5	1.1
0.75	1.3
1.0	1.45
1.5	1.8
2.5	2.2
3	2.55
4	2.85

- stripping length see section feature of inserts on page 13

dimensions indicated are not binding and may be changed without notice

MIXO

the modular inserts must be installed in suitable frames which in turn are installed in traditional housings or COB panel support

frames for modular units page: 151

- features according to EN 61984: **16A 400V 6kV 3**
- certifications: UL, CSA, (CCC); the certifications shown in brackets are being applied for
- for maximum current load, see the insert load curve section on page 35
- for contact crimping instructions, please see the crimping tool section (16A contacts, CCF, CCM and CC...AN series) on pages 296, 300, 304, 306, 308

modular units, crimp connections



16A crimp contacts normal or for advanced opening silver and gold plated



description	part No.	part No.	part No.
without contacts (to be ordered separately) - female inserts for female contacts - male inserts for female contacts	CX 08 CF CX 08 CM		
16A female crimp contacts 0.5 mm ² AWG 20 with no grooves 0.75 mm ² AWG 18 one groove (back side) 1 mm ² AWG 18 one groove 1.5 mm ² AWG 16 two grooves 2.5 mm ² AWG 14 three grooves 3 mm ² AWG 12 one wide groove 4 mm ² AWG 12 with no grooves		silver plated	gold plated
16A male crimp contacts 0.5 mm ² AWG 20 with no grooves 0.75 mm ² AWG 18 one groove (back side) 1 mm ² AWG 18 one groove 1.5 mm ² AWG 16 two grooves 2.5 mm ² AWG 14 three grooves 3 mm ² AWG 12 one wide groove 4 mm ² AWG 12 with no grooves		silver plated	gold plated
16A male crimp contacts for advanced opening 0.5 mm ² AWG 20 with no grooves 0.75 mm ² AWG 18 one groove (back side) 1 mm ² AWG 18 one groove 1.5 mm ² AWG 16 two grooves 2.5 mm ² AWG 14 three grooves		silver plated	gold plated
		CCFA 0.5 CCFA 0.7 CCFA 1.0 CCFA 1.5 CCFA 2.5 CCFA 3.0 CCFA 4.0	CCFD 0.5 CCFD 0.7 CCFD 1.0 CCFD 1.5 CCFD 2.5 CCFD 3.0 CCFD 4.0
		CCMA 0.5 CCMA 0.7 CCMA 1.0 CCMA 1.5 CCMA 2.5 CCMA 3.0 CCMA 4.0	CCMD 0.5 CCMD 0.7 CCMD 1.0 CCMD 1.5 CCMD 2.5 CCMD 3.0 CCMD 4.0
		CC 0.5 AN CC 0.7 AN CC 1.0 AN CC 1.5 AN CC 2.5 AN	

dimensions in mm

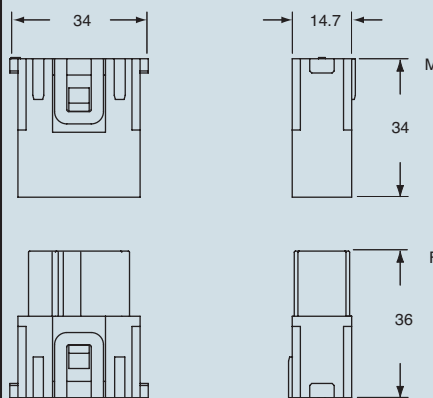

contacts side (front view)

side with reference arrow ▲

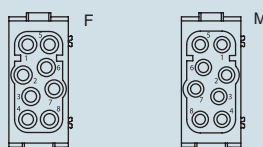

- footprint 1 module

dimensions in mm

CCF and CCM

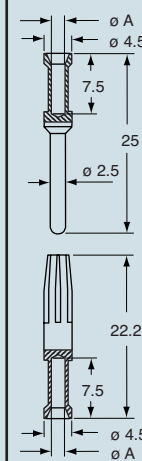

CC...AN

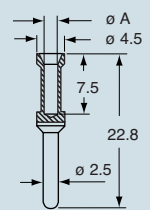

CCF, CCM and CC...AN contacts

conductor section mm ²	Ø slot A (mm)
0.5	1.1
0.75	1.3
1.0	1.45
1.5	1.8
2.5	2.2
3	2.55
4	2.85

- stripping length see section feature of inserts on page 13

dimensions indicated are not binding and may be changed without notice

the modular inserts must be installed in suitable frames which in turn are installed in traditional housings or COB panel support

frames for modular units page: 151

- features according to EN 61984:

16A 500V 6kV 3

- certifications: (UL), (CSA); the certifications shown in brackets are being applied for
- for maximum current load, see the insert load curve section on page 35
- for contact crimping instructions, please see the crimping tool section (16A contacts, CCF, CCM and CC...AN series) on pages 296, 300, 304, 306, 308

* on request, version with 3 fastened CX 20 CF/CM inserts with poles numbered from 1 – 60
 references: **CX 60 CF, CX 60 CM**

**modular units,
spring connections**

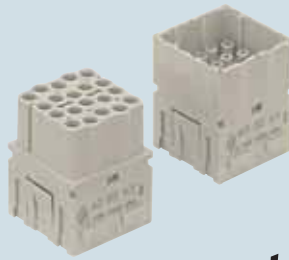

NEW

**16A crimp contacts
normal or for advanced opening
silver and gold plated**



description	part No.	part No.	part No.
without contacts (to be ordered separately) - female inserts for female contacts * - male inserts for female contacts *	CX 20 CF CX 20 CM		
16A female crimp contacts 0.5 mm ² AWG 20 with no grooves 0.75 mm ² AWG 18 one groove (back side) 1 mm ² AWG 18 one groove 1.5 mm ² AWG 16 two grooves 2.5 mm ² AWG 14 three grooves 3 mm ² AWG 12 one wide groove 4 mm ² AWG 12 with no grooves 16A male crimp contacts 0.5 mm ² AWG 20 with no grooves 0.75 mm ² AWG 18 one groove (back side) 1 mm ² AWG 18 one groove 1.5 mm ² AWG 16 two grooves 2.5 mm ² AWG 14 three grooves 3 mm ² AWG 12 one wide groove 4 mm ² AWG 12 with no grooves		CCFA 0.5 CCFA 0.7 CCFA 1.0 CCFA 1.5 CCFA 2.5 CCFA 3.0 CCFA 4.0 CCMA 0.5 CCMA 0.7 CCMA 1.0 CCMA 1.5 CCMA 2.5 CCMA 3.0 CCMA 4.0	CCFD 0.5 CCFD 0.7 CCFD 1.0 CCFD 1.5 CCFD 2.5 CCFD 3.0 CCFD 4.0 CCMD 0.5 CCMD 0.7 CCMD 1.0 CCMD 1.5 CCMD 2.5 CCMD 3.0 CCMD 4.0
16A male crimp contacts for advanced opening 0.5 mm ² AWG 20 with no grooves 0.75 mm ² AWG 18 one groove (back side) 1 mm ² AWG 18 one groove 1.5 mm ² AWG 16 two grooves 2.5 mm ² AWG 14 three grooves		CC 0.5 AN CC 0.7 AN CC 1.0 AN CC 1.5 AN CC 2.5 AN	

dimensions in mm

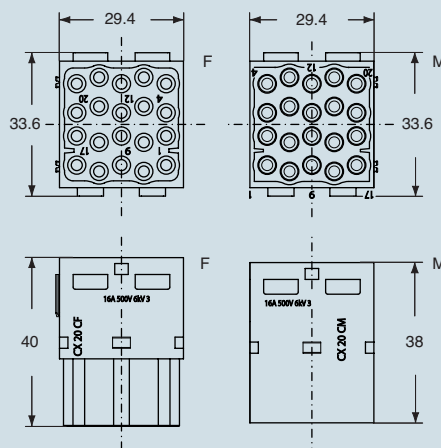

contacts side (front view)

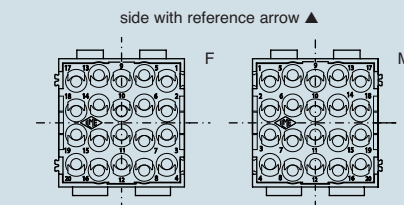

- footprint 2 modules

dimensions in mm

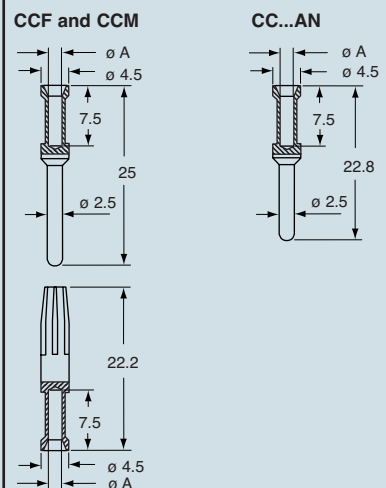

CCF, CCM and CC...AN contacts

conductor section mm ²	ø slot A (mm)
0.5	1.1
0.75	1.3
1.0	1.45
1.5	1.8
2.5	2.2
3	2.55
4	2.85

- stripping length see section feature of inserts on page 13

dimensions indicated are not binding and may be changed without notice

MIXO

the modular inserts must be installed in suitable frames which in turn are installed in traditional housings or COB panel support

frames for modular units page: 151

- features according to EN 61984:
- 16A 400V 6kV 3**
- UL, CSA, CCC, GL certified
- for maximum current load, see the insert load curve section on page 34

modular units,
spring connection



description

- female inserts with female contacts
- male inserts with male contacts

part No.

CX 05 SF
CX 05 SM

connection with spring terminal

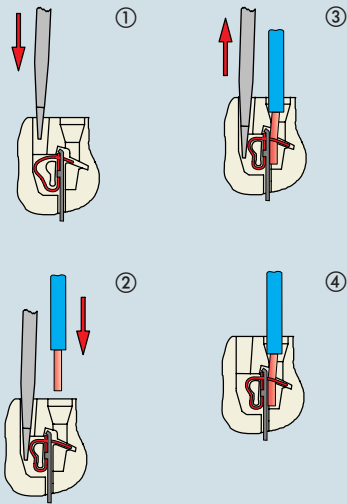

dimensions in mm

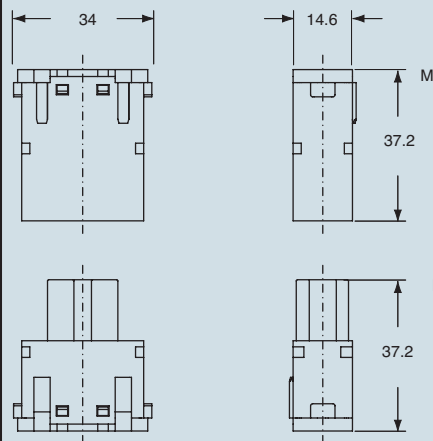

contacts side (front view)

side with reference arrow ▲

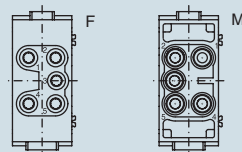

- inserts for section conductors:
0.14 ÷ 2.5 mm² - AWG 26 ÷ 14
- stripping length see section feature of inserts on page 13
- footprint 1 module

dimensions indicated are not binding and may be changed without notice

the modular inserts must be installed in suitable frames which in turn are installed in traditional housings or COB panel support

frames for modular units page: 151

- features according to EN 61984: **10A 250V 4kV 2**
- certifications: UL, CSA, CCC, GL
- for maximum current load, see the insert load curve section on page 35
- for contact crimping, see the crimp tool section (10A contacts, CDF and CDM series) on pages 296, 300, 304, 306, 308
- PCBs interface, see article CIF 2.4

modular units, crimp connections

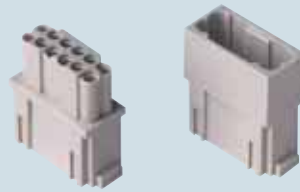

10A crimp contacts silver and gold plated



description	part No.	part No.	part No.
-------------	----------	----------	----------

without contacts (to be ordered separately)
 - female inserts for female contacts
 - male inserts for female contacts

CX 12 DF
CX 12 DM

10A female crimp contacts	
0.14÷0.37 mm ²	AWG 26÷22
0.5 mm ²	AWG 20
0.75 mm ²	AWG 18
1 mm ²	AWG 18
1.5 mm ²	AWG 16
2.5 mm ²	AWG 14
10A male crimp contacts	
0.14÷0.37 mm ²	AWG 26÷22
0.5 mm ²	AWG 20
0.75 mm ²	AWG 18
1 mm ²	AWG 18
1.5 mm ²	AWG 16
2.5 mm ²	AWG 14

silver plated	CDFA 0.3	gold plated	CDFD 0.3
	CDFA 0.5		CDFD 0.5
	CDFA 0.7		CDFD 0.7
	CDFA 1.0		CDFD 1.0
	CDFA 1.5		CDFD 1.5
	CDFA 2.5		CDFD 2.5
silver plated	CDMA 0.3	gold plated	CDMD 0.3
	CDMA 0.5		CDMD 0.5
	CDMA 0.7		CDMD 0.7
	CDMA 1.0		CDMD 1.0
	CDMA 1.5		CDMD 1.5
	CDMA 2.5		CDMD 2.5

dimensions in mm

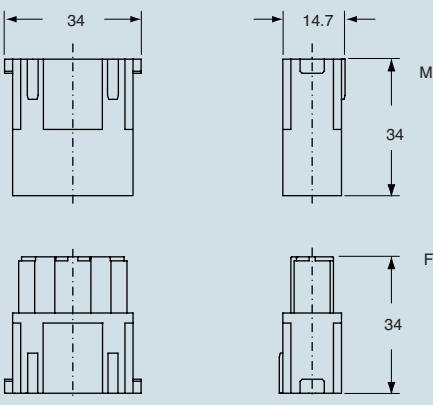

contacts side (front view)

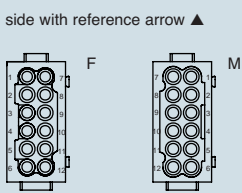

- footprint 1 module

dimensions in mm

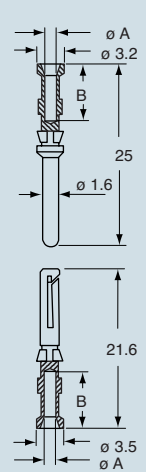

CDF and CDM contacts		
conductor section mm ²	conductor slot ø A (mm)	B (mm)
0.14÷0.37	0.9	8
0.5	1.1	8
0.75	1.3	8
1.0	1.45	8
1.5	1.8	8
2.5	2.2	6

- stripping length see section feature of inserts on page 13

dimensions indicated are not binding and may be changed without notice

MIXO

the modular inserts must be installed in suitable frames which in turn are installed in traditional housings or COB panel support

frames for modular units page: 151

- features according to EN 61984:
- 16A 2900/5000V 15kV 3**
- for contact crimping, see the crimp tool section (16A CCF and CCM series contacts) on pages 296, 300, 304, 306, 308

modular units high voltage, crimp connections



16A crimp contacts silver and gold plated



description	part No.	part No.	part No.																																										
without contacts (to be ordered separately) - female inserts high voltage for female contacts - male inserts high voltage for male contacts	CX 02 HF CX 02 HM																																												
<p>16A female crimp contacts</p> <table border="0"> <tr><td>0.5 mm²</td><td>AWG 20</td><td>with no grooves</td></tr> <tr><td>0.75 mm²</td><td>AWG 18</td><td>one groove (back side)</td></tr> <tr><td>1 mm²</td><td>AWG 18</td><td>one groove</td></tr> <tr><td>1.5 mm²</td><td>AWG 16</td><td>two grooves</td></tr> <tr><td>2.5 mm²</td><td>AWG 14</td><td>three grooves</td></tr> <tr><td>3 mm²</td><td>AWG 12</td><td>one wide groove</td></tr> <tr><td>4 mm²</td><td>AWG 12</td><td>with no grooves</td></tr> </table> <p>16A male crimp contacts</p> <table border="0"> <tr><td>0.5 mm²</td><td>AWG 20</td><td>with no grooves</td></tr> <tr><td>0.75 mm²</td><td>AWG 18</td><td>one groove (back side)</td></tr> <tr><td>1 mm²</td><td>AWG 18</td><td>one groove</td></tr> <tr><td>1.5 mm²</td><td>AWG 16</td><td>two grooves</td></tr> <tr><td>2.5 mm²</td><td>AWG 14</td><td>three grooves</td></tr> <tr><td>3 mm²</td><td>AWG 12</td><td>one wide groove</td></tr> <tr><td>4 mm²</td><td>AWG 12</td><td>with no grooves</td></tr> </table>	0.5 mm ²	AWG 20	with no grooves	0.75 mm ²	AWG 18	one groove (back side)	1 mm ²	AWG 18	one groove	1.5 mm ²	AWG 16	two grooves	2.5 mm ²	AWG 14	three grooves	3 mm ²	AWG 12	one wide groove	4 mm ²	AWG 12	with no grooves	0.5 mm ²	AWG 20	with no grooves	0.75 mm ²	AWG 18	one groove (back side)	1 mm ²	AWG 18	one groove	1.5 mm ²	AWG 16	two grooves	2.5 mm ²	AWG 14	three grooves	3 mm ²	AWG 12	one wide groove	4 mm ²	AWG 12	with no grooves		<p>CCFA 0.5 CCFA 0.7 CCFA 1.0 CCFA 1.5 CCFA 2.5 CCFA 3.0 CCFA 4.0</p> <p style="writing-mode: vertical-rl; transform: rotate(180deg);">silver plated</p>	<p>CCFD 0.5 CCFD 0.7 CCFD 1.0 CCFD 1.5 CCFD 2.5 CCFD 3.0 CCFD 4.0</p> <p style="writing-mode: vertical-rl; transform: rotate(180deg);">gold plated</p> <p>CCMA 0.5 CCMA 0.7 CCMA 1.0 CCMA 1.5 CCMA 2.5 CCMA 3.0 CCMA 4.0</p> <p>CCMD 0.5 CCMD 0.7 CCMD 1.0 CCMD 1.5 CCMD 2.5 CCMD 3.0 CCMD 4.0</p>
0.5 mm ²	AWG 20	with no grooves																																											
0.75 mm ²	AWG 18	one groove (back side)																																											
1 mm ²	AWG 18	one groove																																											
1.5 mm ²	AWG 16	two grooves																																											
2.5 mm ²	AWG 14	three grooves																																											
3 mm ²	AWG 12	one wide groove																																											
4 mm ²	AWG 12	with no grooves																																											
0.5 mm ²	AWG 20	with no grooves																																											
0.75 mm ²	AWG 18	one groove (back side)																																											
1 mm ²	AWG 18	one groove																																											
1.5 mm ²	AWG 16	two grooves																																											
2.5 mm ²	AWG 14	three grooves																																											
3 mm ²	AWG 12	one wide groove																																											
4 mm ²	AWG 12	with no grooves																																											

dimensions in mm

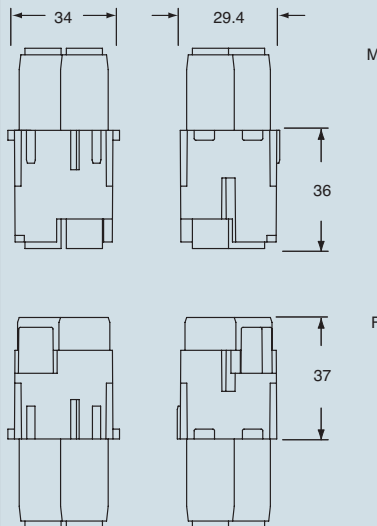

contacts side (front view)

side with reference arrow ▲

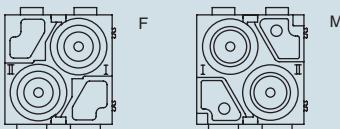

- footprint 2 modules

dimensions in mm

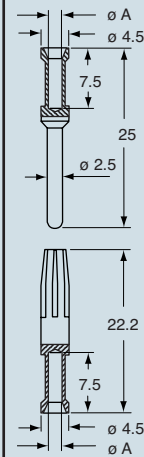

CCF and CCM contacts

conductor section mm ²	ø slot A (mm)
0.5	1.1
0.75	1.3
1.0	1.45
1.5	1.8
2.5	2.2
3	2.55
4	2.85

- stripping length see section feature of inserts on page 13

dimensions indicated are not binding and may be changed without notice



the modular inserts must be installed in suitable frames which in turn are installed in traditional housings or COB panel support

frames for modular units page: 151

- features according to EN 61984:

10A 50V 0,8kV 3

- certifications: UL, CSA (CX 01 B are being applied for), CCC (no CX 01 B)
- for contact crimping, see the crimp tool section (10A CDF and CDM series contacts) pages 296, 300, 304, 306, 308
- extraction tool for BUS shielded connectors from MIXO BUS insert CX BES article

seat for shielded connectors, shielded connectors



10A crimp contacts silver and gold plated



description	part No.	part No.	part No.
seats for two shielded connectors - female inserts, two seats for BUS connectors - male inserts, two seats for BUS connectors	CX 02 BF CX 02 BM		
shielded connectors - female inserts, four contacts seat + shield - male inserts, four contacts seat + shield	CX 04 BF CX 04 BM		
shielded connectors - female inserts, one contacts seat + shield - male inserts, one contacts seat + shield	CX 01 BF CX 01 BM		
10A female crimp contacts 0.14÷0.37 mm ² AWG 26÷22 0.5 mm ² AWG 20 0.75 mm ² AWG 18 1 mm ² AWG 18 1.5 mm ² AWG 16 2.5 mm ² AWG 14		CDFA 0.3 CDFA 0.5 CDFA 0.7 CDFA 1.0 CDFA 1.5 CDFA 2.5	CDFD 0.3 CDFD 0.5 CDFD 0.7 CDFD 1.0 CDFD 1.5 CDFD 2.5
10A male crimp contacts 0.14÷0.37 mm ² AWG 26÷22 0.5 mm ² AWG 20 0.75 mm ² AWG 18 1 mm ² AWG 18 1.5 mm ² AWG 16 2.5 mm ² AWG 14		CDMA 0.3 CDMA 0.5 CDMA 0.7 CDMA 1.0 CDMA 1.5 CDMA 2.5	CDMD 0.3 CDMD 0.5 CDMD 0.7 CDMD 1.0 CDMD 1.5 CDMD 2.5

silver plated

gold plated

Note:

The shielded connectors have their shield insulated from the enclosure's earthing point.
If you wish to earth-connect the shield, install on the panel an anchor for CR..ST shielded cables.

dimensions in mm

CX 02 BF, CX 02 BM

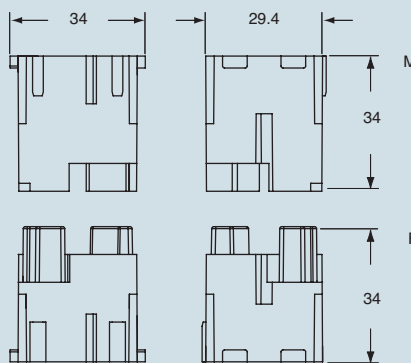

dimensions in mm

CX 04 BF, CX 04 BM

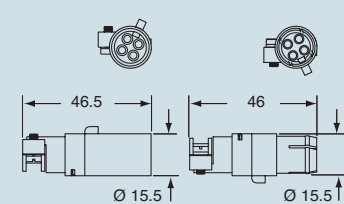

CX 01 BF, CX 01 BM

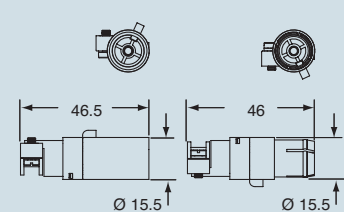

contacts side (front view)
side with reference arrow ▲

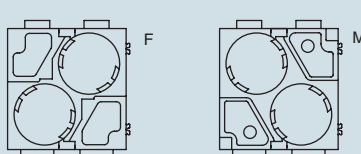

- footprint 2 modules

dimensions of crimp contacts in mm

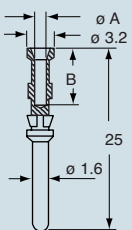

CDF and CDM contacts

conductor section mm ²	conductor slot ø A (mm)	B (mm)
0.14÷0.37	0.9	8
0.5	1.1	8
0.75	1.3	8
1.0	1.45	8
1.5	1.8	8
2.5	2.2	6

- stripping length see section feature of inserts on page 13

dimensions indicated are not binding and may be changed without notice

MIXO

the modular inserts must be installed in suitable frames which in turn are installed in traditional housings or COB panel support

frames for modular units.. page: 151

- features according to EN 61984:
- 10A 250V 4kV 3**
- certifications: (UL), (CSA); the certifications shown in brackets are being applied for
- for contact crimping, see the crimp tool section (10A contacts CDF and CDM series) on pages 296, 300, 304, 306, 308

WARNING:

the female inserts can only be used on high or flush mounting enclosures

housing for RJ45 connectors, RJ45 connectors



NEW

10A crimp contacts silver and gold plated



description	part No.	part No.	part No.
without RJ45 connector and without contacts (to be ordered separately)			
- socket inserts for 1 RJ45 female connector and for 4 10A (CDF) female contacts	CX 01 JF		
- plug inserts for 1 RJ45 male connector and for 4 10A (CDM) male contacts	CX 01 JM		
- RJ45 female connector, 8 data contacts	CX 8 JF		
- RJ45 female connector, 8 data contacts / 2 power contacts	CX 8/2 JF		
- RJ45 male connector, 4 data contacts	CX 4 JM		
- RJ45 male connector, 4 data contacts / 2 power contacts	CX 4/2 JM		
- RJ45 male connector, 6 data contacts / 2 power contacts	CX 6/2 JM		
- RJ45 male connector, 8 data contacts	CX 8 JM		
- RJ45 male connector, 4 data contacts cat. 5 e	CX 4E JM		
10A female crimp contacts 0.14÷0.37 mm ² AWG 26÷22 0.5 mm ² AWG 20 0.75 mm ² AWG 18 1 mm ² AWG 18 1.5 mm ² AWG 16 2.5 mm ² AWG 14		C DFA 0.3 C DFA 0.5 C DFA 0.7 C DFA 1.0 C DFA 1.5 C DFA 2.5	C DFD 0.3 C DFD 0.5 C DFD 0.7 C DFD 1.0 C DFD 1.5 C DFD 2.5
10A male crimp contacts 0.14÷0.37 mm ² AWG 26÷22 0.5 mm ² AWG 20 0.75 mm ² AWG 18 1 mm ² AWG 18 1.5 mm ² AWG 16 2.5 mm ² AWG 14		C DMA 0.3 C DMA 0.5 C DMA 0.7 C DMA 1.0 C DMA 1.5 C DMA 2.5	C DMD 0.3 C DMD 0.5 C DMD 0.7 C DMD 1.0 C DMD 1.5 C DMD 2.5

RJ45 connector features:

- RJ45 insert, Class 5 Ethernet
- nominal current: 2.1A at 70 °C
- nominal voltage: 50VDC / 35VAC
- IDC terminal:
- for 0.22 mm² ÷ 0.24 mm² (AWG 24) data cables
- for 0.34 mm² ÷ 0.38 mm² (AWG 22) power cables
- temperature range: from -20°C to 120 °C
- nickel plated brass screening
- crimp pliers: CJPZY
- screened cable stripper: CJST
- female/female socket connectors with "crossover" link

dimensions in mm
CX 01 JF, CX 01 JM

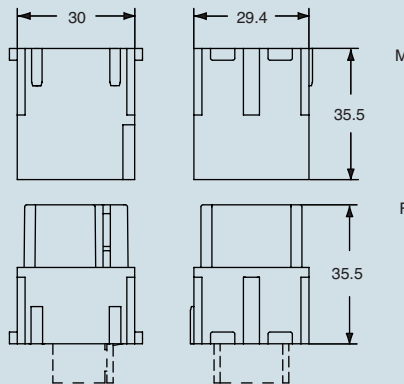

contacts side (front view)
side with reference arrow ▲

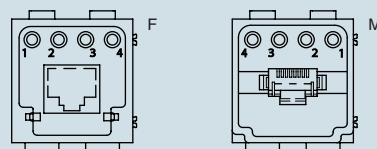

- footprint 2 modules

dimensions in mm
CX 8 JF, CX 8/2 JF

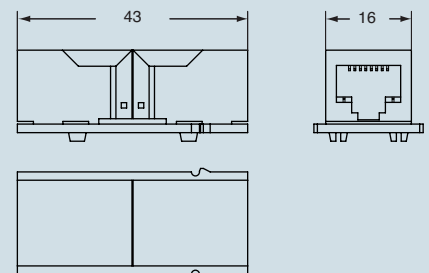

CX 4 JM, CX 4/2 JM, CX 6/2 JM, CX 8 JM, CX 4E JM

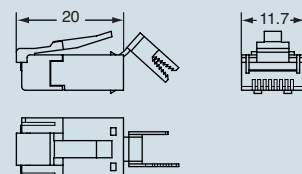

dimensions indicated are not binding and may be changed without notice

the modular inserts must be installed in suitable frames which in turn are installed in traditional housings or COB panel support

frames for modular units.. page: 151

- features according to EN 61984: **10A 250V 4kV 3**
- certifications: (UL), (CSA); the certifications shown in brackets are being applied for
- for contact crimping, see the crimp tool section (10A contacts CDF and CDM series) on pages 296, 300, 304, 306, 308

WARNING:

the female inserts can only be used on high or flush mounting enclosures

housing for RJ45 connectors, RJ45 connectors



10A crimp contacts silver and gold plated



description	part No.
without RJ45 connector and without contacts (to be ordered separately)	
- socket inserts for 2 RJ45 female connectors and for 8 10A (CDF) female contacts	CX 02 JF
- plug inserts for 2 RJ45 male connectors and for 8 10A (CDM) male contacts	CX 02 JM
- RJ45 female connector, 8 data contacts	CX 8 JF
- RJ45 female connector, 8 data contacts / 2 power contacts	CX 8/2 JF
- RJ45 male connector, 4 data contacts	CX 4 JM
- RJ45 male connector, 4 data contacts / 2 power contacts	CX 4/2 JM
- RJ45 male connector, 6 data contacts / 2 power contacts	CX 6/2 JM
- RJ45 male connector, 8 data contacts	CX 8 JM
- RJ45 male connector, 4 data contacts cat. 5 e	CX 4E JM
10A female crimp contacts	
0.14÷0.37 mm ² AWG 26÷22	
0.5 mm ² AWG 20	
0.75 mm ² AWG 18	
1 mm ² AWG 18	
1.5 mm ² AWG 16	
2.5 mm ² AWG 14	
10A male crimp contacts	
0.14÷0.37 mm ² AWG 26÷22	
0.5 mm ² AWG 20	
0.75 mm ² AWG 18	
1 mm ² AWG 18	
1.5 mm ² AWG 16	
2.5 mm ² AWG 14	

description	part No.
10A female crimp contacts	
0.14÷0.37 mm ² AWG 26÷22	
0.5 mm ² AWG 20	
0.75 mm ² AWG 18	
1 mm ² AWG 18	
1.5 mm ² AWG 16	
2.5 mm ² AWG 14	
10A male crimp contacts	
0.14÷0.37 mm ² AWG 26÷22	
0.5 mm ² AWG 20	
0.75 mm ² AWG 18	
1 mm ² AWG 18	
1.5 mm ² AWG 16	
2.5 mm ² AWG 14	

part No.	part No.
CDFA 0.3	CDFD 0.3
CDFA 0.5	CDFD 0.5
CDFA 0.7	CDFD 0.7
CDFA 1.0	CDFD 1.0
CDFA 1.5	CDFD 1.5
CDFA 2.5	CDFD 2.5
CDMA 0.3	CDMD 0.3
CDMA 0.5	CDMD 0.5
CDMA 0.7	CDMD 0.7
CDMA 1.0	CDMD 1.0
CDMA 1.5	CDMD 1.5
CDMA 2.5	CDMD 2.5

- RJ45 connector features:**
- RJ45 insert, Class 5 Ethernet
 - nominal current: 2.1A at 70 °C
 - nominal voltage: 50VDC / 35VAC
 - IDC terminal:
 - for 0.22 mm² ÷ 0.24 mm² (AWG 24) data cables
 - for 0.34 mm² ÷ 0.38 mm² (AWG 22) power cables
 - temperature range: from -20°C to 120 °C
 - nickel plated brass screening
 - crimp pliers: CJPZY
 - screened cable stripper: CJST
 - female/female socket connectors with "crossover" link

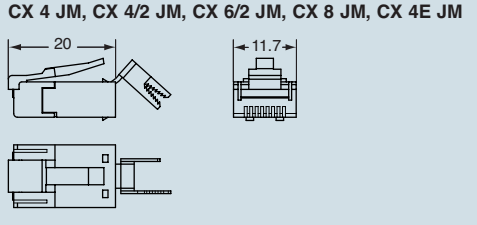
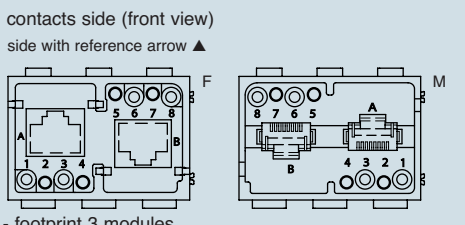
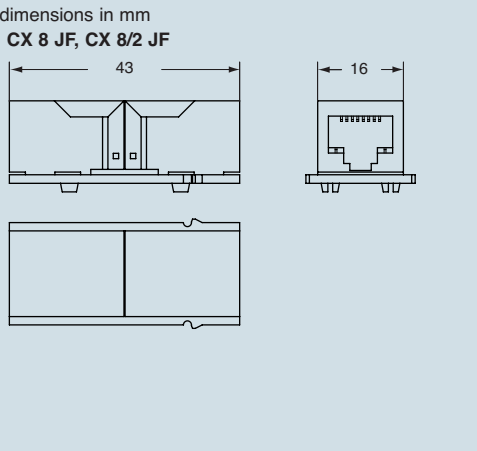
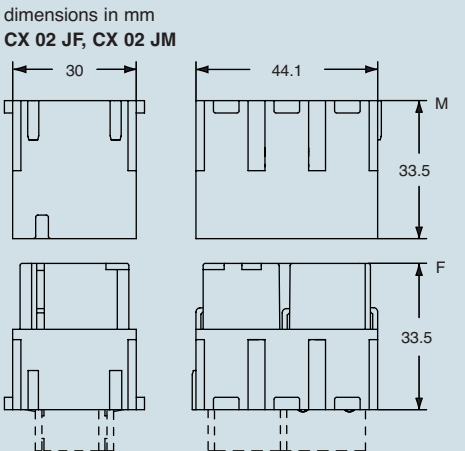

dimensions indicated are not binding and may be changed without notice

- footprint 3 modules

MIXO

the modular inserts must be installed in suitable frames which in turn are installed in traditional housings or COB panel support

frames for modular units page: 151

Warnings:

- 1) Please note that the VDE-Directives do not allow the combination of electrical and liquid connections within the same connector for clear safety reasons.
- 2) CRM/F CX code pins and guides must be used for pneumatic contacts modules. These pins also provide coding if pneumatic contacts modules are used exclusively.

modular units with 2 or 3 seats

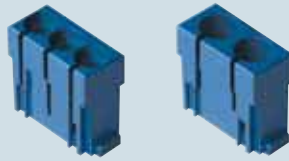

pneumatic contacts with or without closing valve



description	part No.	part No.
without contacts (to be ordered separately) - inserts with 3 housings for tube Ø 1.6 ÷ 4.0 - inserts with 2 housings for tube Ø 6.0	CX 03 P CX 02 P	
female contacts without closing valve - for tubes with internal ø 1.6 mm - for tubes with internal ø 3 mm - for tubes with internal ø 4 mm - for tubes with internal ø 6 mm male contacts without closing valve - for tubes with internal ø 1.6 mm - for tubes with internal ø 3 mm - for tubes with internal ø 4 mm - for tubes with internal ø 6 mm		CX 1.6 PF CX 3.0 PF CX 4.0 PF CX 6.0 PF CX 1.6 PM CX 3.0 PM CX 4.0 PM CX 6.0 PM
female contacts with closing valve - for tubes with internal ø 1.6 mm - for tubes with internal ø 3 mm - for tubes with internal ø 4 mm - for tubes with internal ø 6 mm male contacts (use contacts without closing valve)		CX 1.6 VC CX 3.0 VC CX 4.0 VC CX 6.0 VC

Use of units for pneumatic contacts

- identical male and female modular units
- pneumatic contacts for pressure values up to 8 bar, for use with clean and dry compressed air
- contacts for gas and liquids on request (see warning)
- use of tubes with Ø 1.6 - 3 - 4 and 6 mm, and possible replacement of tubes with assembled units
- possibility of using tubes with different diameters in the same modular unit
- female contacts with or without closing valve
- working temperature range - 40 °C ÷ + 80 °C

dimensions in mm

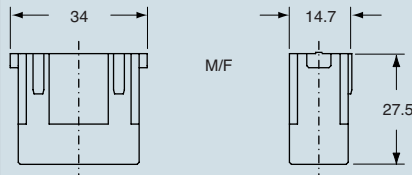

contacts side (front view)

side with reference arrow ▲

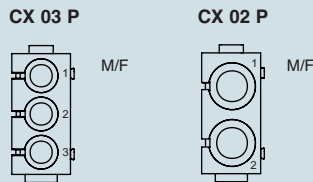

- footprint 1 module

dimensions in mm

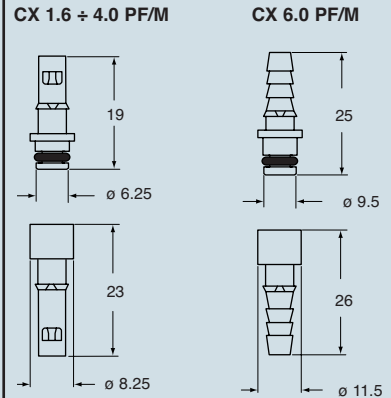

dimensions indicated are not binding and may be changed without notice

the modular units inserts must be installed in suitable frames which in turn are installed in traditional housings or COB panel support. Alternatively, individual modules with a width of 14.7, can be installed in plastic supports.

frames for modular units page: 151

dummy module

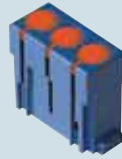

description

part No.

dummy module for unused frame seats

CX FM

dimensions in mm

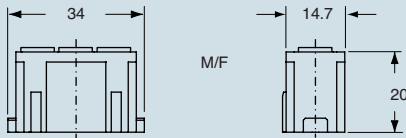

position of units (coupling side view)

side with reference arrow ▲



- footprint 1 module

dimensions indicated are not binding and may be changed without notice

MIXO

- die-cast zinc alloy frames
- with VDE ground contacts
- possibility of mounting female and male modular units on the same frame
- frames supplied with lock-in tab to attach units
- polarisation on frames
- code pins CR..CX

Warning

the module support frames are marked:

- with upper-case letters **A-B, A-C, A-D** and **A-F** (for use in hoods)
- with lower-case letters **a-b, a-c, a-d** and **a-f** (for use in housings)

Positioning the modules in the frames according to the respective letters is ensuring the specular assembly of modules, for which the hood will be coupled correctly to the housing.

frames for modular units



frames for modular units with lock-in tabs

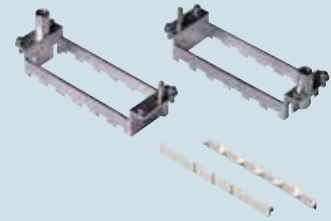

description	part No.	part No.	part No.
for CZ enclosures, size 49.16	CX 01 T		
frames for modular units (module lock-in tabs included) - for 2 modular units - for 3 modular units - for 4 modular units - for 6 modular units		type for hoods	type for housings
lock-in tabs for modular units (6 units) dividable		CX 02 TM CX 03 TM CX 04 TM CX 06 TM	CX 02 TF CX 03 TF CX 04 TF CX 06 TF
		CX CFM	

polarisation of frames with relative identification letters and couplings

frame for hoods ¹⁾ **frames for housings** ¹⁾

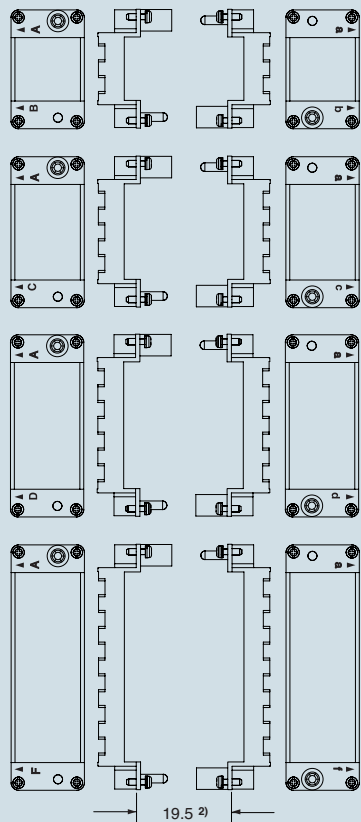

¹⁾ the frames can be used either in hoods or housings, for a correct coupling please use both frame types (one with upper-case letters and the other with lower-case letters)

²⁾ distance for electric and fibre optic contacts: max 21 mm
distance for pneumatic contacts: max 20.5 mm

dimensions indicated are not binding and may be changed without notice

dimensions in mm

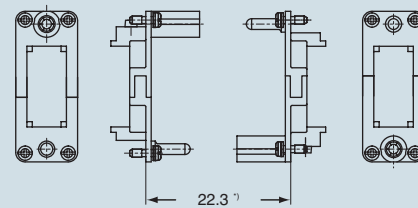
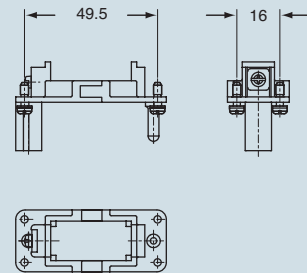

^{*)} distance for electric contacts: max 24 mm
distance for pneumatic contacts: max 23.5 mm

dimensions in mm

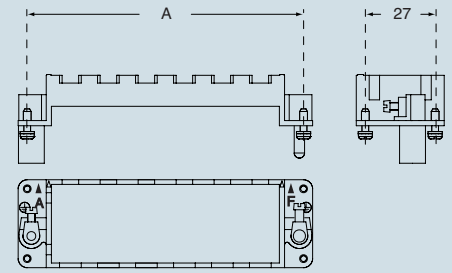

part No.	A (mm) for housings size	
CX 02 TM / TF	44	44.27
CX 03 TM / TF	57	57.27
CX 04 TM / TF	77.5	77.27
CX 06 TM / TF	104	104.27

- large earth terminal for cables from 4÷6 mm², AWG 12÷10
- small earth terminal for cables from 1÷2,5 mm², AWG 18÷14

position of modules (contact side view)

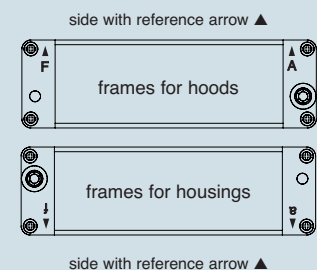

When two or more identical connectors of the MIXO series are used, coded pins are used prevent incorrect coupling (CR...CX series).

CX CFM

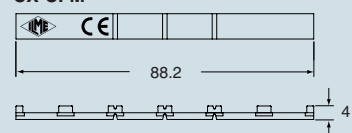



inserts:		page
CK	3 poles + ⊕	36
CK	4 poles + ⊕	36
CKS	3 poles + ⊕	37
CKS	4 poles + ⊕	37
CD	7 poles + ⊕	39
CD	8 poles	40
CQ	5 poles + ⊕	63
CQ	12 poles + ⊕	62

overall dimensions:
21 x 21 mm

bulkhead housings



angled bulkhead housings



description	part No.	part No. (entry - Pg 11)	part No. (entry - M 20)
with lever ¹⁾	CK 03 I (white)		
with lever ¹⁾	CK 03 IN (black)		
without cable gland outlet, with lever ¹⁾		CK 03 IA (white)	
without cable gland outlet, with lever ¹⁾		CK 03 IAN (black)	
with threaded entry and lever ¹⁾		CK 03 IAPS (white)	MK IAP20 (white)
with threaded entry and lever ¹⁾		CK 03 IAPNS (black)	MK IAPN20 (black)
seal and screw kit for IP66/IP67 ²⁾ for CK, CQ 05, CKS inserts	CKR 65	CKR 65	
seal and screw kit for IP66/IP67 ²⁾ for CD 07/08 inserts	CKR 65 D	CKR 65 D	

panel cut-out for enclosures, in mm

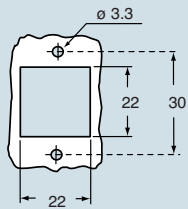

- enclosures with IP44 degree of protection, obtained by the elimination of the flexible washer normal supplied with the insert
- To achieve the IP66/IP67 protection rating, a kit is available which includes a seal to be fitted under the insert fastening screw supplied with the kit (see example illustrated), instead of the screw with spring washer supplied with the insert

Note:
The CQ 12 inserts are already fitted with seal and screw, allowing IP66/IP67 protection rating to be achieved.

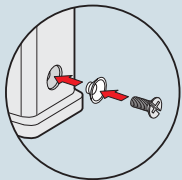

CALUS® Type 12
Type 4/4X only
with CKR 65 (D)

dimensions indicated are not binding
and may be changed without notice

dimensions in mm

CK I(N)

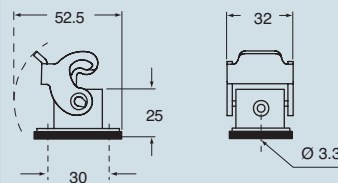

dimensions in mm

CK IA(N)

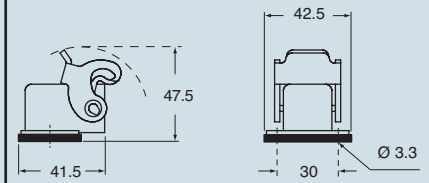

CK IAP(N)S and MK IAP(N)

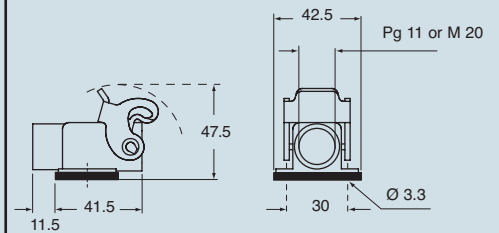

size 21.21

inserts:		page
CK	3 poles + ⊕	36
CK	4 poles + ⊕	36
CKS	3 poles + ⊕	37
CKS	4 poles + ⊕	37
CD	7 poles + ⊕	39
CD	8 poles	40
CQ	5 poles + ⊕	63
CQ	12 poles + ⊕	62

overall dimensions:
21 x 21 mm

hoods



covers



description	part No. (entry - Pg 11)	part No. (entry - M 20)	part No.
with pegs, top entry ¹⁾	CK 03 VS (white)	MK V20 (white)	
with pegs, top entry ¹⁾	CK 03 VNS (black)	MK VN20 (black)	
with pegs, side entry ¹⁾	CK 03 VAS (white)	MK VA20 (white)	
with pegs, side entry ¹⁾	CK 03 VANS (black)	MK VAN20 (black)	
with lever, top entry ¹⁾	CK 03 VGS (white)	MK VG20 (white)	
with lever, top entry ¹⁾	CK 03 VGNS (black)	MK VGN20 (black)	
with pegs and gasket, for female inserts			CK 03 C (white)
with pegs and gasket, for female inserts			CK 03 CN (black)
with pegs, for male inserts			CK 03 CA (white)
with pegs, for male inserts			CK 03 CAN (black)
with lever and gasket, for female inserts			CK 03 CX (white)
with lever and gasket, for female inserts			CK 03 CXN (black)
with lever, for male inserts			CK 03 CXA (white)
with lever, for male inserts			CK 03 CXAN (black)
seal and screw kit for IP66/IP67 ²⁾ for CK, CQ 05, CKS inserts	CKR 65		
seal and screw kit for IP66/IP67 ²⁾ for CD 07/08 inserts	CKR 65 D		

- 1) enclosures with IP44 degree of protection, obtained by the elimination of the flexible washer normal supplied with the insert
- 2) To achieve the IP66/IP67 protection rating, a kit is available which includes a seal to be fitted under the insert fastening screw supplied with the kit (see example illustrated), instead of the screw with spring washer supplied with the insert

Note:
The CQ 12 inserts are already fitted with seal and screw, allowing IP66/IP67 protection rating to be achieved.

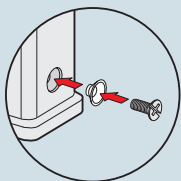

dimensions in mm

CK V(N)S and MK V(N)

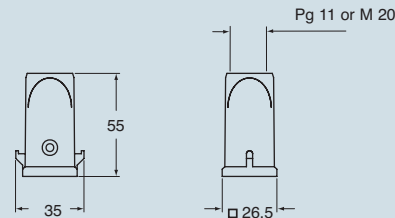

CK VA(N)S and MK VA(N)

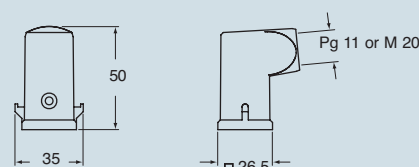

CK VG(N)S and MK VG(N)

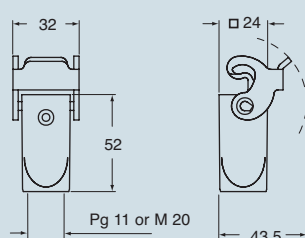

dimensions in mm

CK C(N)

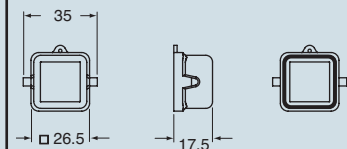

CK CA(N)

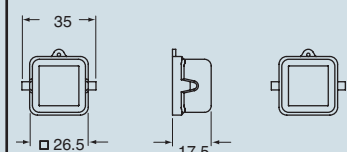

CK CX(N)

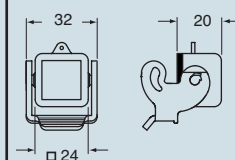

CK CXA(N)

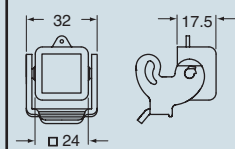

CRUS® Type 12
Type 4/4X only
with CKR 65 (D)

dimensions indicated are not binding
and may be changed without notice



inserts:		page
CK	3 poles + ⊕	36
CK	4 poles + ⊕	36
CKS	3 poles + ⊕	37
CKS	4 poles + ⊕	37
CD	8 poles	40
CQ	5 poles + ⊕	63
CQ	12 poles + ⊕	62

overall dimensions:
21 x 21 mm

bulkhead housings



angled bulkhead housings



description	part No.	part No. (entry - Pg 11)	part No. (entry - M 20)
with lever in galvanised steel ¹⁾ with stainless steel lever ¹⁾	CKA 03 I CKAX 03 I		
without cable gland outlet, lever in galvanised steel ¹⁾ without cable gland outlet, stainless steel lever ¹⁾		CKA 03 IA CKAX 03 IA	
with threaded entry, lever in galvanised steel ¹⁾ with threaded entry, stainless steel lever ¹⁾ with threaded entry, lever in galvanised steel ¹⁾ , bottom closed with threaded entry, stainless steel lever ¹⁾ , bottom closed		CKA 03 IAPS CKAX 03 IAPS CKA 03 APS CKAX 03 APS	MKA IAP20 MKAX IAP20 MKA AP20 MKAX AP20
seal and screw kit for IP66/IP67 ²⁾ for CK, CQ 05, CKS inserts	CKR 65	CKR 65	
seal and screw kit for IP66/IP67 ²⁾ for CD 07/08 inserts	CKR 65 D	CKR 65 D	

panel cut-out for enclosures, in mm

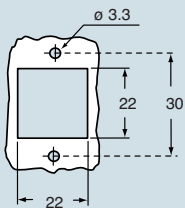

- 1) enclosures with IP44 degree of protection.
- 2) To achieve the IP66/IP67 protection rating, a kit is available which includes a seal to be fitted under the insert fastening screw supplied with the kit (see example illustrated), instead of the screw with spring washer supplied with the insert

Note:
The CQ 12 inserts are already fitted with seal and screw, allowing IP66/IP67 protection rating to be achieved.

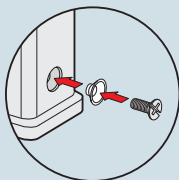

CRUS® Type 12
Type 4/4X only
with CKR 65 (D)

dimensions indicated are not binding
and may be changed without notice

dimensions in mm

CKA I

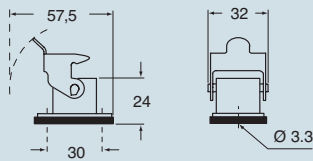

CKAX I

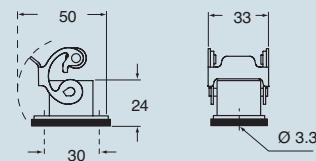

dimensions in mm

CKA IA

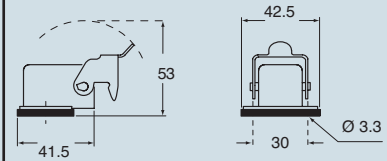

CKAX IA

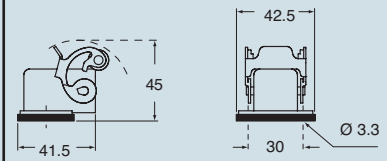

CKA IAPS (CKA APS) and MKA IAP (MKA AP)

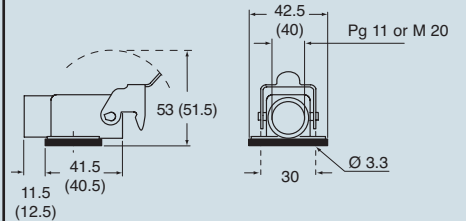

CKAX IAPS (CKAX APS) and MKAX IAP (MKAX AP)

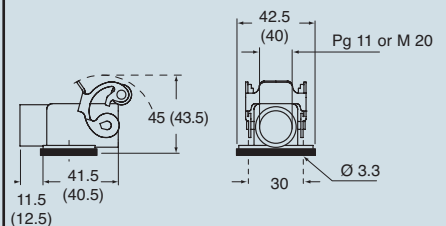

size 21.21



inserts:		page
CK	3 poles + ⊕	36
CK	4 poles + ⊕	36
CKS	3 poles + ⊕	37
CKS	4 poles + ⊕	37
CD	8 poles	40
CQ	5 poles + ⊕	63
CQ	12 poles + ⊕	62

overall dimensions:
21 x 21 mm

hoods



covers



description	part No. (entry - Pg 11)	part No. (entry - M 20)	part No.
with pegs, top entry ¹⁾ with pegs, side entry ¹⁾	CKA 03 VS CKA 03 VAS	MKA V20 MKA VA20	
with lever in galvanised steel, top entry ¹⁾ with stainless steel lever, top entry ¹⁾	CKA 03 VGS CKAX 03 VGS	MKA VG20 MKAX VG20	
with pegs and gasket, for female inserts with pegs, for male inserts			CKA 03 C ²⁾ CKA 03 CA ²⁾
with stainless steel lever and gasket, for female inserts with stainless steel lever, for male inserts			CKAX 03 CX CKAX 03 CXA
seal and screw kit for IP66/IP67 ³⁾ for CK, CQ 05, CKS inserts	CKR 65		
seal and screw kit for IP66/IP67 ³⁾ for CD 08 inserts	CKR 65 D		

- 1) enclosures with IP44 degree of protection.
- 2) better to use with CKAX enclosures (stainless steel lever).
- 3) To achieve the IP66/PI67 protection rating, a kit is available which includes a seal to be fitted under the insert fastening screw supplied with the kit (see example illustrated), instead of the screw with spring washer supplied with the insert

Note:
The CQ 12 inserts are already fitted with seal and screw, allowing IP66/IP67 protection rating to be achieved.

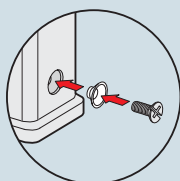

dimensions in mm

CKA VS and MKA V

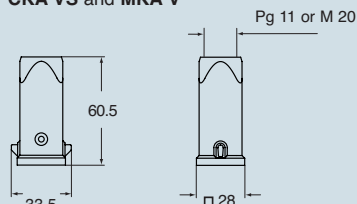

CKA VAS and MKA VA

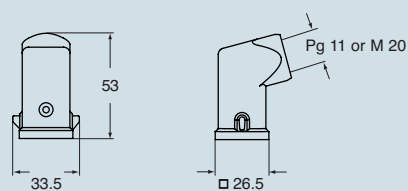

CKA VGS and MKA VG

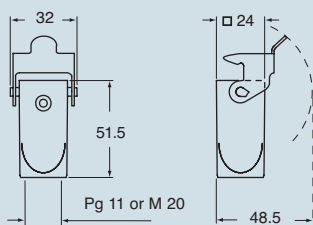

CKAX VGS and MKAX VG

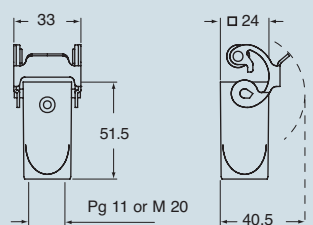

dimensions in mm

CKA C

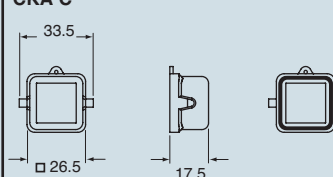

CKA CA

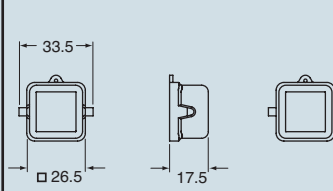

CKAX CX

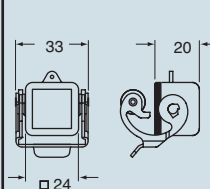

CKAX CXA

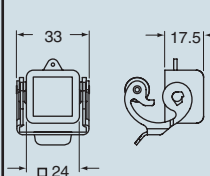

CEAUS®
Type 12
Type 4/4X only
with CKR 65 (D)

dimensions indicated are not binding
and may be changed without notice

size 21.21



inserts:		page
CK	3 poles + ⊕	36
CK	4 poles + ⊕	36
CKS	3 poles + ⊕	37
CKS	4 poles + ⊕	37
CD	8 poles	40
CQ	5 poles + ⊕	63
CQ	12 poles + ⊕	62

overall dimensions:
21 x 21 mm

**bulkhead housings
straight and angled**



hoods

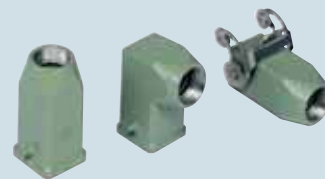

description	part No. (entry - Pg 11)	part No. (entry - M 20)	part No. (entry - Pg 11)	part No. (entry - M 20)
with stainless steel lever ¹⁾	CKAXW 03 I			
without cable gland outlet, stainless steel lever ¹⁾	CKAXW 03 IA			
with threaded entry, stainless steel lever ¹⁾	CKAXW 03 IAP	MKAXW IAP20		
with threaded entry, stainless steel lever ¹⁾ , bottom closed	CKAXW 03 AP	MKAXW AP20		
with pegs, top entry ¹⁾			CKAW 03 V	MKAW V20
with pegs, side entry ¹⁾			CKAW 03 VA	MKAW VA20
with stainless steel lever, top entry ¹⁾			CKAXW 03 VG	MKAXW VG20
seal and screw kit for IP66/IP67 ²⁾ for CK, CQ 05, CKS inserts	CKR 65		CKR 65	
seal and screw kit for IP66/IP67 ²⁾ for CD 08 inserts	CKR 65 D		CKR 65 D	

panel cut-out for enclosures, in mm

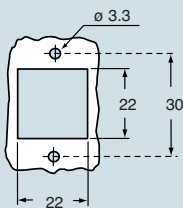

- enclosures with IP44 degree of protection.
- To achieve the IP66/IP67 protection rating, a kit is available which includes a seal to be fitted under the insert fastening screw supplied with the kit (see example illustrated), instead of the screw with spring washer supplied with the insert

Note:
The CQ 12 inserts are already fitted with seal and screw, allowing IP66/IP67 protection rating to be achieved.

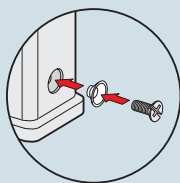

CRUS® Type 12
Type 4/4X only
with CKR 65 (D)

dimensions indicated are not binding
and may be changed without notice

dimensions in mm

CKAXW I

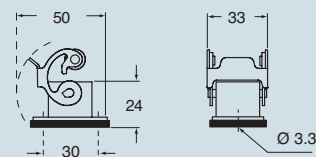

CKAXW IA

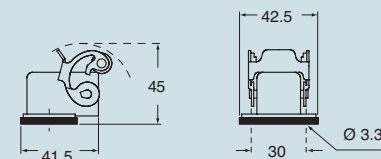

**CKAXW IAP (CKAXW AP) and
MKAXW IAP (MKAXW AP)**

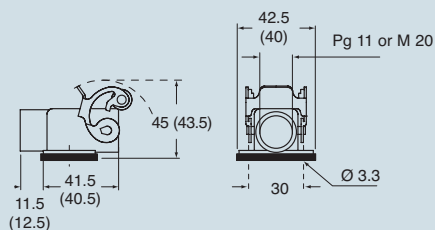

dimensions in mm

CKAW V and MKAW V

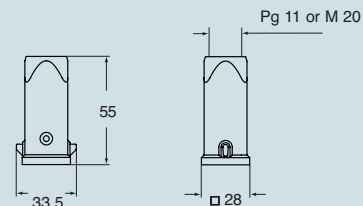

CKAW VA and MKAW VA

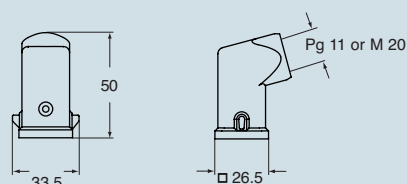

CKAXW VG and MKAXW VG

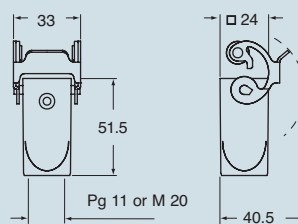

size 21.21



inserts:		page
CK	3 poles + ⊕	36
CK	4 poles + ⊕	36
CKS	3 poles + ⊕	37
CKS	4 poles + ⊕	37
CD	8 poles	40
CQ	5 poles + ⊕	63
CQ	12 poles + ⊕	62

overall dimensions:
21 x 21 mm

**bulkhead housings
straight and angled**

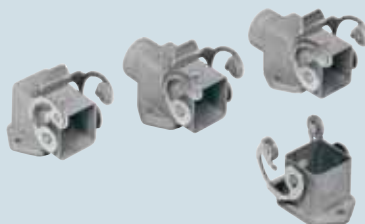

hoods



description	part No. (entry - Pg 11)	part No. (entry - M 20)	part No. (entry - Pg 11)	part No. (entry - M 20)
with stainless steel lever ¹⁾	CKAXS 03 I			
without cable gland outlet, stainless steel lever ¹⁾	CKAXS 03 IA			
with threaded entry, stainless steel lever ¹⁾	CKAXS 03 IAP	MKAXS IAP20		
with threaded entry, stainless steel lever ¹⁾ , bottom closed	CKAXS 03 AP	MKAXS AP20		
with pegs, top entry ¹⁾			CKAS 03 V	MKAS V20
with pegs, side entry ¹⁾			CKAS 03 VA	MKAS VA20
with stainless steel lever, top entry ¹⁾			CKAXS 03 VG	MKAXS VG20
seal and screw kit for IP66/IP67 ²⁾ for CK, CQ 05, CKS inserts	CKR 65		CKR 65	
seal and screw kit for IP66/IP67 ²⁾ for CD 08 inserts	CKR 65 D		CKR 65 D	

panel cut-out for enclosures, in mm

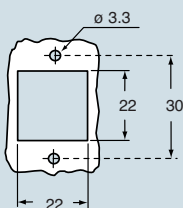

- 1) enclosures with IP44 degree of protection.
- 2) To achieve the IP66/IP67 protection rating, a kit is available which includes a seal to be fitted under the insert fastening screw supplied with the kit (see example illustrated), instead of the screw with spring washer supplied with the insert

Note:
The CQ 12 inserts are already fitted with seal and screw, allowing IP66/IP67 protection rating to be achieved.

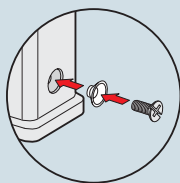

CEC®
Type 12
Type 4/4X only
with CKR 65 (D)

dimensions indicated are not binding
and may be changed without notice

dimensions in mm

CKAXS I

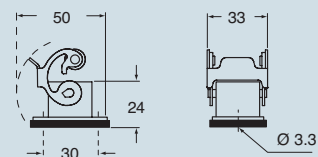

CKAXS IA

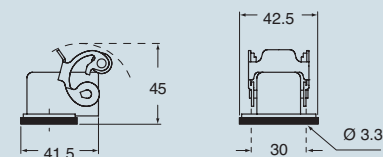

**CKAXS IAP (CKAXS AP) and
MKAXS IAP (MKAXS AP)**

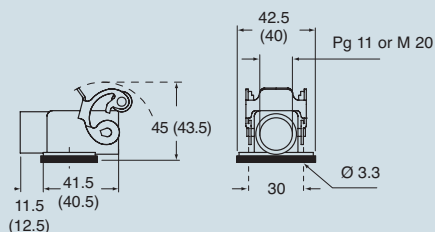

dimensions in mm

CKAS V and MKAS V

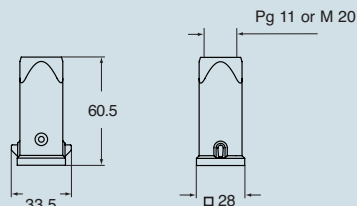

CKAS VA and MKAS VA

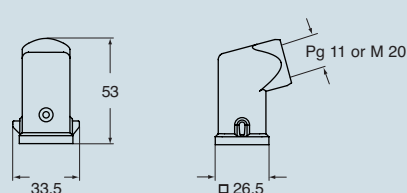

CKAXS VG and MKAXS VG

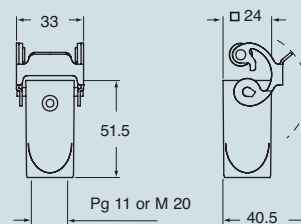

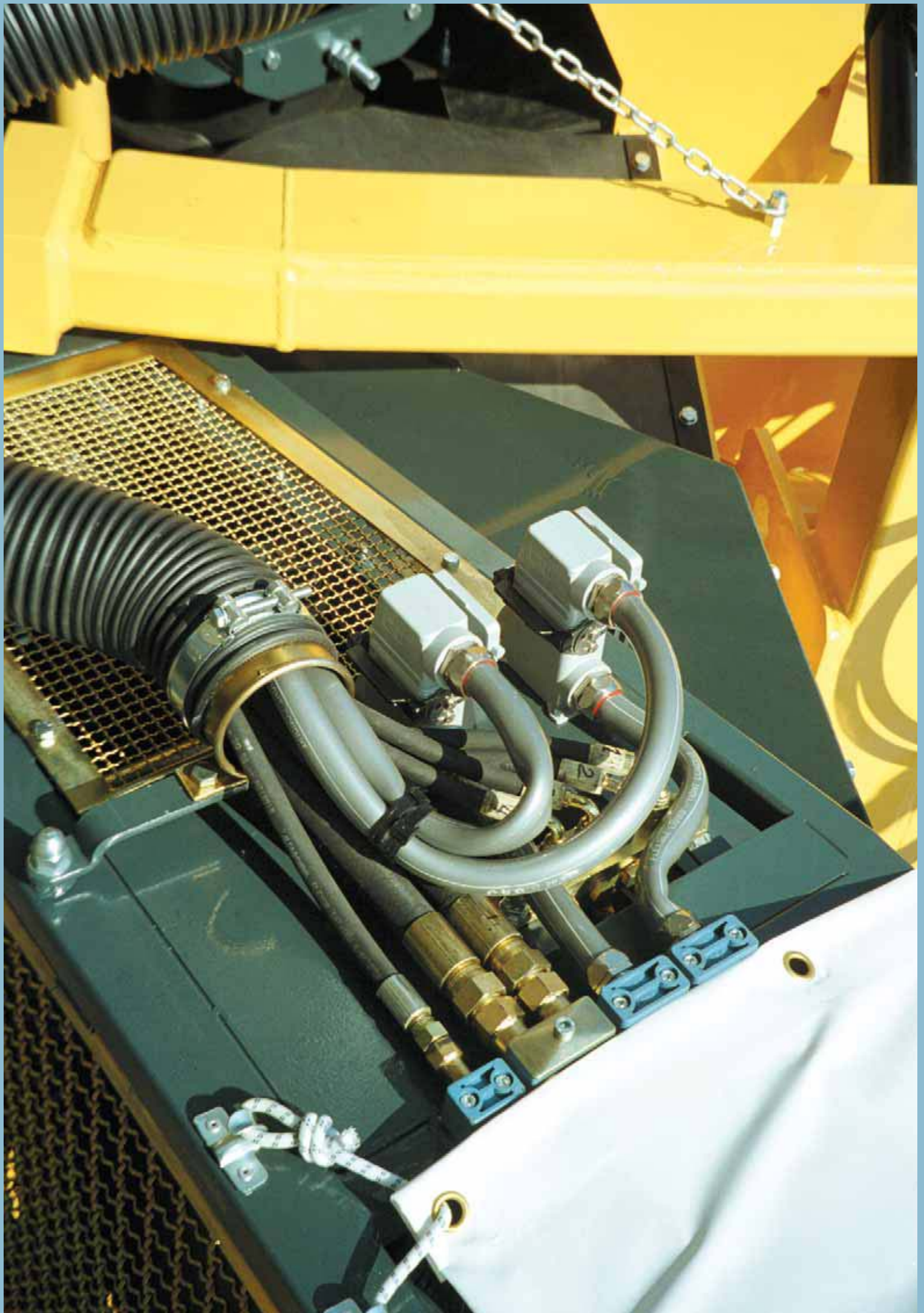

inserts:	page
CQ 08..... 8 poles + ⊕	64
CQ 04/2..... 4 poles + 2 poles + ⊕	65

**bulkhead mounting housing
single closure**



NEW

**hood
for single closure**



NEW

description	part No.	part No.	entry Pg
with lever	CQ 08 I		
with pegs, side entry *		CQ 08 VA	16
with pegs, top entry *		CQ 08 V	21

panel cut-out for enclosures, in mm

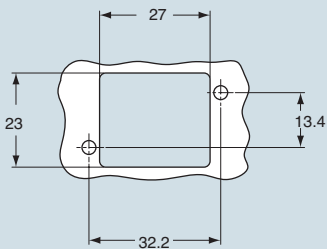

* Pg male thread on outside of enclosure

dimensions in mm

CQ I

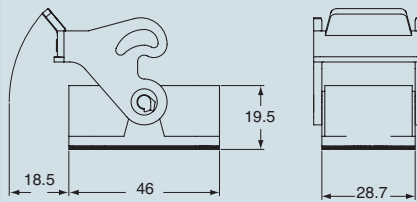

dimensions in mm

CQ VA

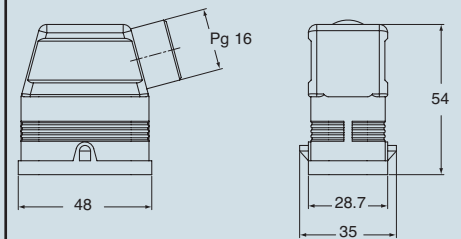

CQ V

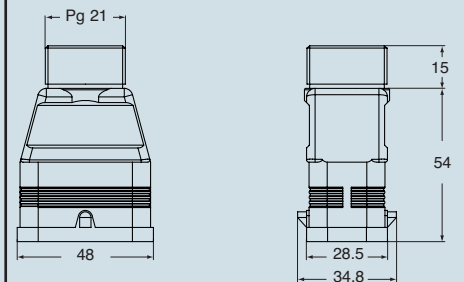

dimensions indicated are not binding and may be changed without notice

inserts:	page
CQ 08..... 8 poles + ⊕	64
CQ 04/2 4 poles + 2 poles + ⊕	65

hood with single lever



NEW

flying covers for single closure thermoplastic resin cable clamps

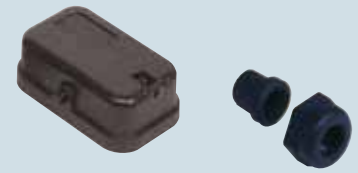

NEW

description	part No.	entry Pg	part No.
with lever, top entry *	CQ 08 VG	21	
cover with 2 pegs for socket inserts cover with 2 pegs for plug inserts			CQ 08 C CQ 08 CA
cable clamping head and seal for CQ 08 VA enclosure cable clamping head and seal for CQ 08 V and VG enclosures			CRQ 16 CRQ 21

* Pg male thread on outside of enclosure

diameter of cables that may be used with cable glands:
- CRQ 16: 10 - 14.5 mm
- CRQ 21: 14 - 18 mm

dimensions in mm

CQ VG

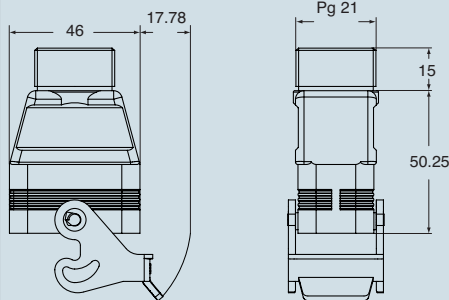

dimensions in mm

CQ C and CQ CA

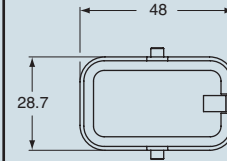

CRQ 16 and CRQ 21

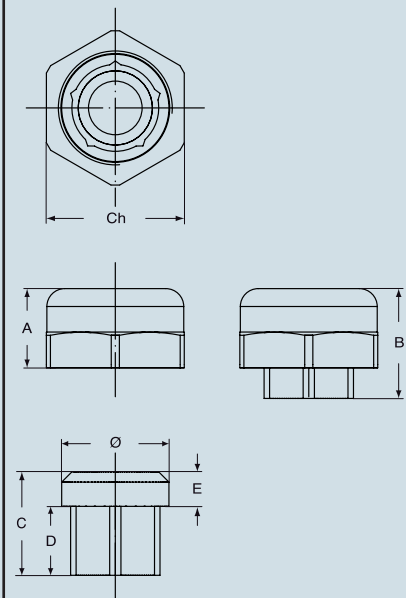

type	A	B	C	D	E	Ø	Ch
CRQ 16	15.5	21.5	20.25	13.5	6.75	21	27
CRQ 21	18.2	27.5	25	15.5	9	26.5	33

dimensions indicated are not binding and may be changed without notice



inserts:		page
CD	15 poles + ⊕	41
CDA	10 poles + ⊕	66
CDC	10 poles + ⊕	67
MIXO	1 module	137÷151

bulkhead mounting housings with single lever



surface mounting housings with single lever



description	part No.	part No.		part No.	
		entry Pg	entry M	entry Pg	entry M
with basic lever	CZI 15 L				
with basic lever and cover	CZI 15 LS				
with basic lever		CZP 15 L	16		
with basic lever		CZP 15 L2	16 x 2	MZP 15 L225	25
with basic lever		CZP 15 L21	21	MZP 15 L25	25
with basic lever and cover		CZP 15 LS221	21 x 2	MZP 15 LS225	25 x 2

panel cut-out for bulkhead mounting housings in mm

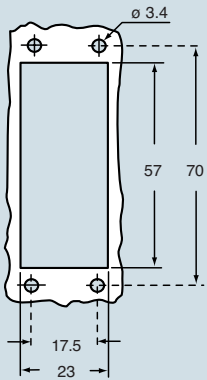

dimensions in mm

CZI L

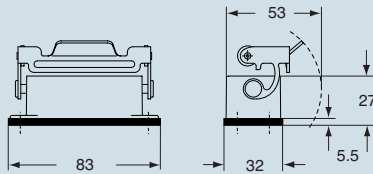

CZI LS

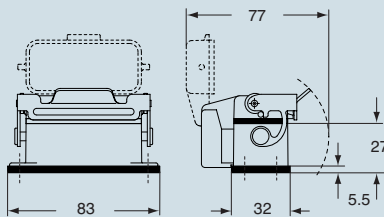

dimensions in mm

CZP L and MZP L

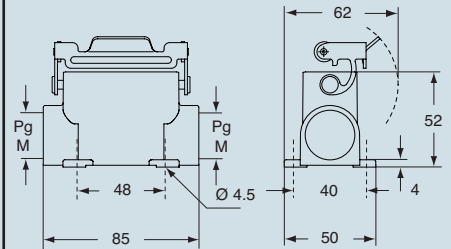

CZP LS and MZP LS

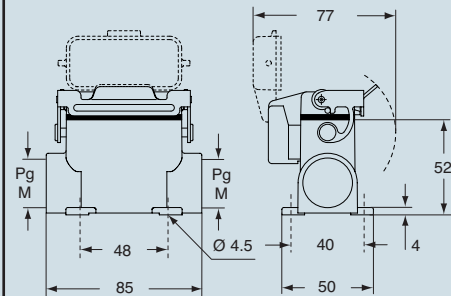

N.B.: the enclosures ensure IP66 protection rating when mated and locked with the closing levers.

CALUS® Type 4/4X/12

dimensions indicated are not binding and may be changed without notice

size 49.16



inserts:		page
CD	15 poles + ⊕	41
CDA	10 poles + ⊕	66
CDC	10 poles + ⊕	67
MIXO	1 module	137÷151

Covers L and LG versions are not suitable to be used with code pins. If this application is required please contact ILME SpA.

hoods for single lever



covers

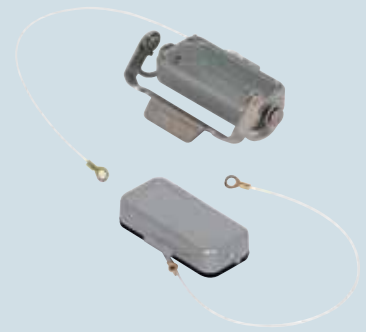

description	part No.		part No.		part No.
		entry Pg		entry M	
with pegs, side entry	CZO 15 L	16	MZO 15 L20	20	
with pegs, side entry			MZO 15 L25	25	
with pegs, side entry, high construction	CZAO 15 L16	16	MZAO 15 L20	20	
with pegs, side entry, high construction	CZAO 15 L21	21	MZAO 15 L25	25	
with pegs, top entry	CZV 15 L	13.5	MZV 15 L20	20	
with pegs, top entry, high construction	CZAV 15 L16	16	MZAV 15 L20	20	
with pegs, top entry, high construction	CZAV 15 L21	21	MZAV 15 L25	25	
with pegs, side entry, high construction, without adaptor *	CZFO 15 L16	16	MZFO 15 L20	20	
with pegs, side entry, high construction, without adaptor *	CZFO 15 L21	21	MZFO 15 L25	25	
with pegs, top entry, high construction, without adaptor *	CZFV 15 L16	16	MZFV 15 L20	20	
with pegs, top entry, high construction, without adaptor *	CZFV 15 L21	21	MZFV 15 L25	25	
with pegs (for enclosures with lever)					CZC 15 L
with basic lever (for enclosures with pegs)					CZC 15 LG

* enclosure without adaptor, threaded on the body, to be used only with a complete cable clamp.

dimensions in mm
CZO L and MZO L

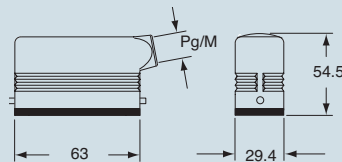

CZAO L - MZAO L and CZAV L - MZAV L

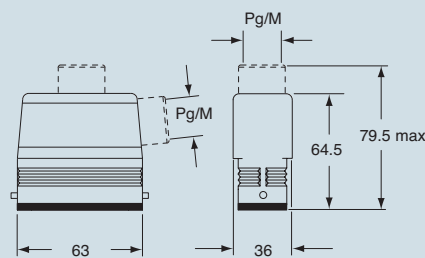

CZV L and MZV L

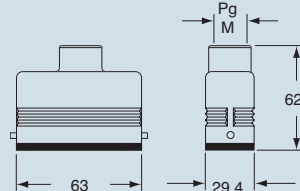

CZFO L - MZFO L and CZFV L - MZFV L

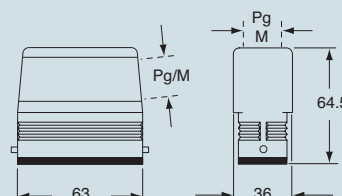

dimensions in mm

CZC L

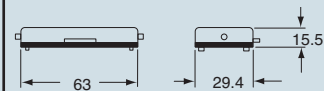

CZC LG

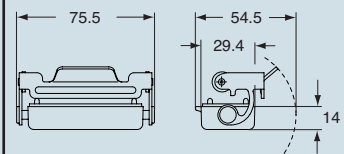

dimensions indicated are not binding and may be changed without notice

size 49.16

inserts:		page
CD	15 poles + ⊕	41
CDA	10 poles + ⊕	66
CDC	10 poles + ⊕	67
MIXO	1 module	137÷151

Covers L and LG versions are not suitable to be used with code pins. If this application is required please contact ILME SpA.

housings and cover

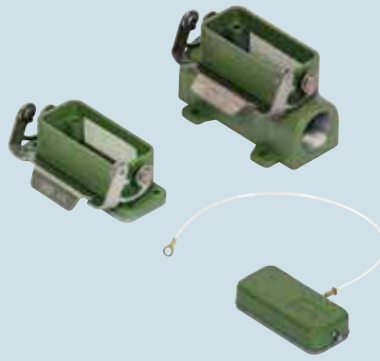

hoods and cover



description	part No.		part No.		part No.		part No.	
		entry Pg		entry M		entry Pg		entry M
bulkhead housing, with lever	CZIW 15 L	---						
surface housing, with lever	CZPW 15 L2	16 x 2	MZPW 15 L225	25 x 2				
cover with pegs (for enclosures with lever)	CZCW 15 L							
with pegs, side entry					CZOW 15 L	16	MZOW 15 L20	20
with pegs, side entry					CZAOW 15 L21	21	MZOW 15 L25	25
with pegs, side entry, high construction					CZVW 15 L	13.5	MZAOW 15 L25	25
with pegs, top entry					CZAVW 15 L21	21	MZVW 15 L20	20
with pegs, top entry, high construction					MZAVW 15 L25	25		
cover with lever (for enclosures with pegs)					CZCW 15 LG			

panel cut-out for bulkhead mounting housings in mm

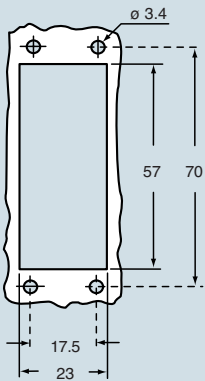

dimensions in mm

CZIW L

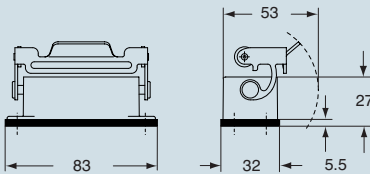

CZPW L and MZPW L

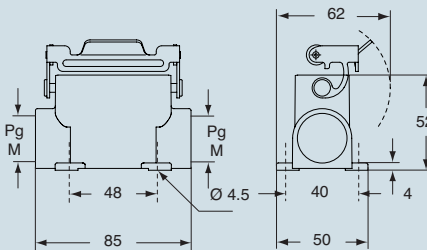

CZCW L

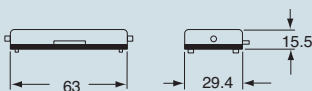

dimensions in mm

CZOW L and MZOW L

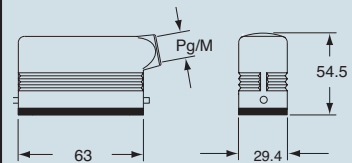

CZAOW L - MZAOW L and CZAVW L - MZAVW L

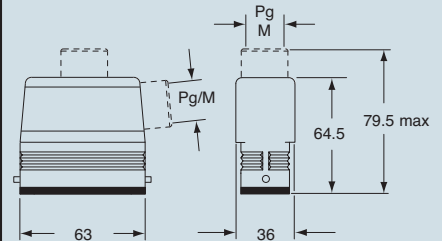

CZVW L and MZVW L

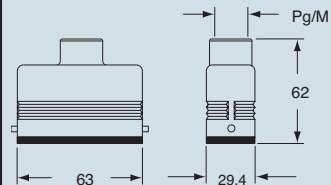

CZCW LG

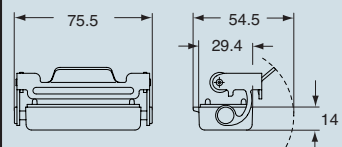

CALUS® Type 4/4X/12

dimensions indicated are not binding and may be changed without notice

size 49.16



inserts:		page
CD	15 poles + ⊕	41
CDA	10 poles + ⊕	66
CDC	10 poles + ⊕	67
MIXO	1 module	137÷151

Covers L and LG versions are not suitable to be used with code pins. If this application is required please contact ILME SpA.

housings and cover for electromagnetic compatibility

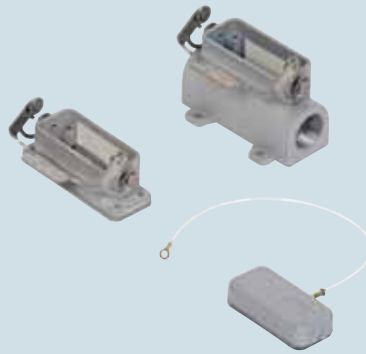

hoods and cover for electromagnetic compatibility



description	part No.	entry Pg	part No.	entry M	part No.	entry Pg	part No.	entry M
bulkhead housing, with lever	CZIS 15 L	---						
surface housing, with lever	CZPS 15 L2	16 x 2	MZPS 15 L225	25 x 2				
cover with pegs (for enclosures with lever)	CZCS 15 L							
with pegs, side entry					CZOS 15 L	16	MZOS 15 L20	20
with pegs, side entry					CZAOS 15 L21	21	MZOS 15 L25	25
with pegs, side entry, high construction					CZVS 15 L	13.5	MZAOS 15 L25	25
with pegs, top entry					CZAOS 15 L21	21	MZVS 15 L20	20
with pegs, top entry, high construction							MZAVS 15 L25	25
cover with lever (for enclosures with pegs)					CZCS 15 LG			

panel cut-out for bulkhead mounting housings in mm

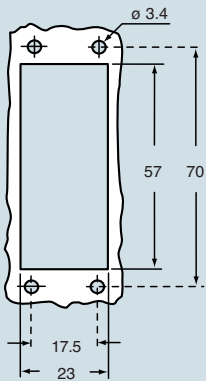

dimensions in mm

CZIS L

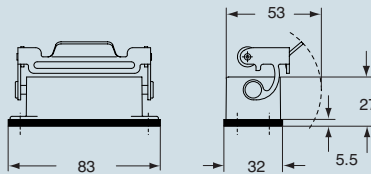

CZPS L and MZPS L

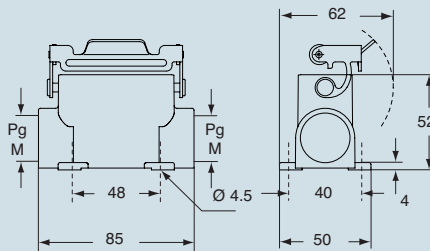

CZCS L

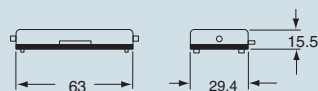

dimensions in mm

CZOS L and MZOS L

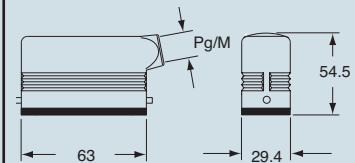

CZAOS L - MZAOS L and CZAOS L - MZAOS L

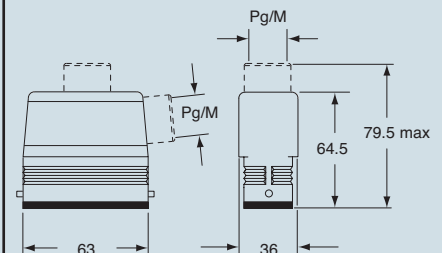

CZVS L and MZVS L

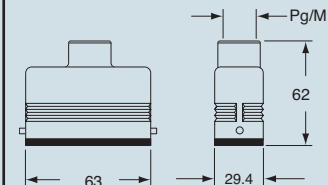

CZCS LG

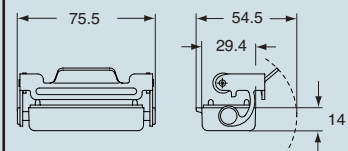

CALUS® Type 4/4X/12

dimensions indicated are not binding and may be changed without notice

size 49.16



inserts:		page
CD	25 poles + ⊕	42
CDD	38 poles + ⊕	54
CDA	16 poles + ⊕	68
CDC	16 poles + ⊕	69

bulkhead mounting housings with single lever



surface mounting housings with single lever



description	part No.	part No.		part No.	
		entry Pg	entry M	entry Pg	entry M
with basic lever	CZI 25 L				
with basic lever and cover	CZI 25 LS				
with basic lever, high construction		CZAP 25 L	16		
with basic lever, high construction		CZAP 25 L2	16 x 2	MZAP 25 L225	25 x 2
with basic lever, high construction		CZAP 25 L21	21	MZAP 25 L25	25
with basic lever and cover, high construction		CZAP 25LS221	21 x 2	MZAP 25LS225	25 x 2

panel cut-out for bulkhead mounting housings in mm

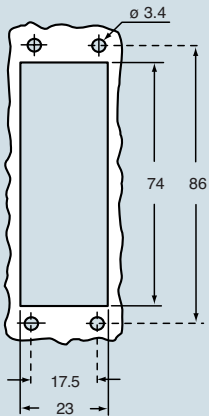

dimensions in mm

CZI L

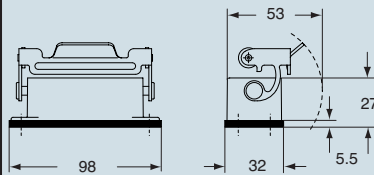

CZI LS

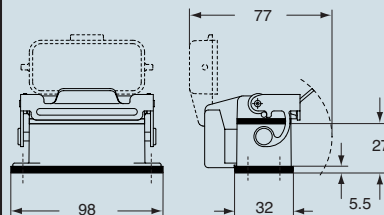

dimensions in mm

CZAP L and MZAP L

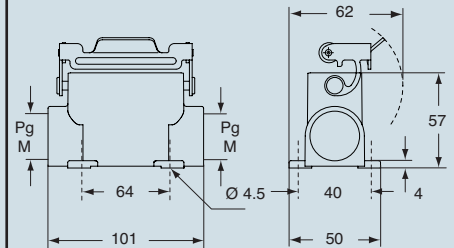

CZAP LS and MZAP LS

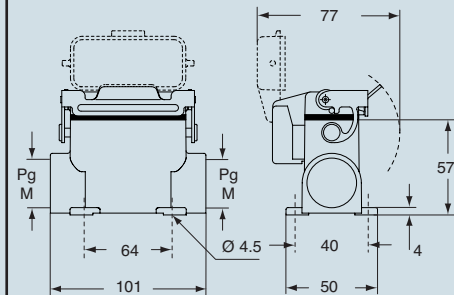

N.B.: the enclosures ensure IP66 protection rating when mated and locked with the closing levers.

CALUS® Type 4/4X/12

dimensions indicated are not binding and may be changed without notice

size 66.16

inserts:		page
CD	25 poles + ⊕	42
CDD	38 poles + ⊕	54
CDA	16 poles + ⊕	68
CDC	16 poles + ⊕	69

Covers L and LG versions are not suitable to be used with code pins. If this application is required please contact ILME SpA.

hoods for single lever



covers



description	part No.		part No.		part No.
		entry Pg		entry M	
with pegs, side entry	CZO 25 L	16	MZO 25 L20	20	
with pegs, side entry			MZO 25 L25	25	
with pegs, side entry, high construction	CZAO 25 L16	16	MZAO 25 L20	20	
with pegs, side entry, high construction	CZAO 25 L21	21	MZAO 25 L25	25	
with pegs, top entry	CZV 25 L	16	MZV 25 L20 **	20	
with pegs, top entry, high construction	CZAV 25 L16	16	MZAV 25 L20	20	
with pegs, top entry, high construction	CZAV 25 L21	21	MZAV 25 L25	25	
with pegs, side entry, high construction, without adaptor *	CZFO 25 L16	16	MZFO 25 L20	20	
with pegs, side entry, high construction, without adaptor *	CZFO 25 L21	21	MZFO 25 L25	25	
with pegs, top entry, high construction, without adaptor *	CZFV 25 L16	16	MZFV 25 L20	20	
with pegs, top entry, high construction, without adaptor *	CZFV 25 L21	21	MZFV 25 L25	25	
with pegs (for enclosures with lever)					CZC 25 L
with basic lever (for enclosures with pegs)					CZC 25 LG

* enclosure without adaptor, threaded on the body, to be used only with a complete cable clamp.

** can only be used with a complete cable clamp (to be purchased separately)

dimensions in mm

CZO L and MZO L

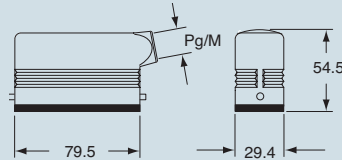

CZAO L - MZAO L and CZAV L - MZAV L

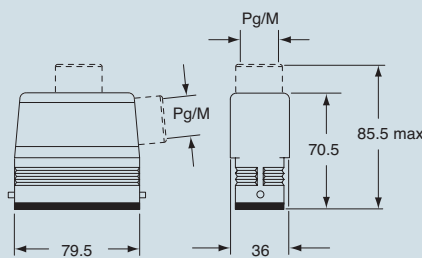

CZV L and MZV L

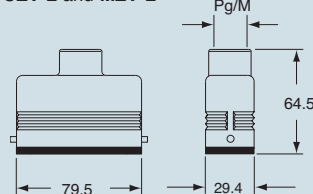

CZFO L - MZFO L and CZFV L - MZFV L

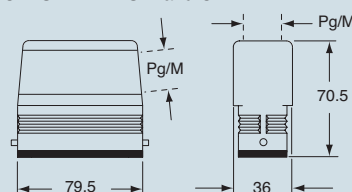

dimensions in mm

CZC L

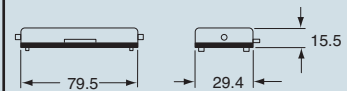

CZC LG

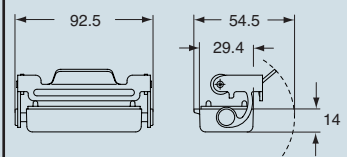

CALUS® Type 4/4X/12

dimensions indicated are not binding and may be changed without notice

size 66.16

inserts:		page
CD	25 poles + ⊕	42
CDD	38 poles + ⊕	54
CDA	16 poles + ⊕	68
CDC	16 poles + ⊕	69

Covers L and LG versions are not suitable to be used with code pins. If this application is required please contact ILME SpA.

housings and cover

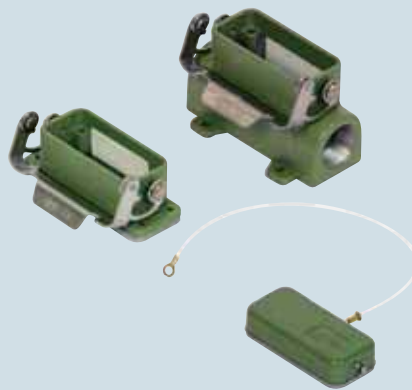

hoods and cover

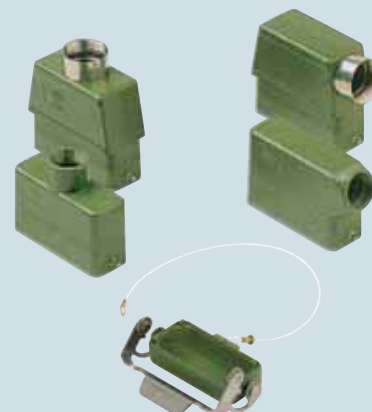

description	part No.		part No.		part No.		part No.	
		entry Pg		entry M		entry Pg		entry M
bulkhead housing, with lever	CZIW 25 L	---						
surface housing, with lever, high construction	CZAPW 25 L2	16 x 2	MZAPW 25L225	25 x 2				
cover with pegs (for enclosures with lever)	CZCW 25 L							
with pegs, side entry					CZOW 25 L	16	MZOW 25 L20	20
with pegs, side entry					CZAOW 25 L21	21	MZOW 25 L25	25
with pegs, side entry, high construction					CZVW 25 L	16	MZAOW 25 L25	25
with pegs, top entry					CZAVW 25 L21	21	MZVW 25 L20*	20
with pegs, top entry, high construction					CZCW 25 LG		MZAVW 25 L25	25
cover with lever (for enclosures with pegs)								

panel cut-out for bulkhead mounting housings in mm

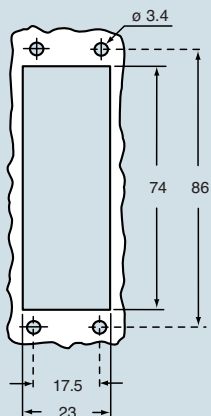

* to be used only with cable gland (to be ordered separately).

dimensions in mm

CZIW L

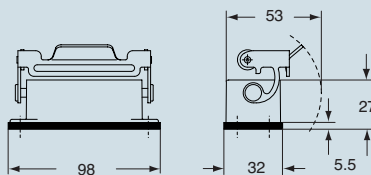

CZAPW L and MZAPW L

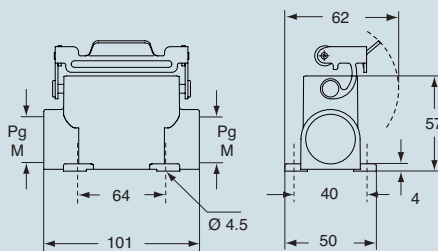

CZCW L

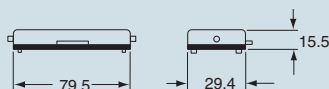

dimensions in mm

CZOW L and MZOW L

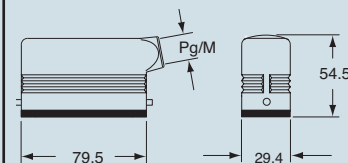

CZAOW L - MZAOW L and CZAVW L - MZAVW L

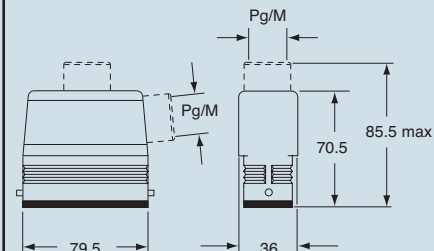

CZVW L and MZVW L

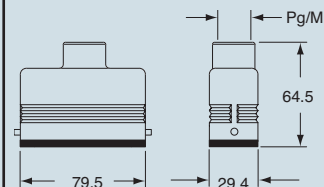

CZCW LG

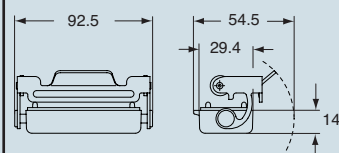

CAUS® Type 4/4X/12

dimensions indicated are not binding and may be changed without notice

size 66.16



inserts:		page
CD	25 poles + ⊕	42
CDD	38 poles + ⊕	54
CDA	16 poles + ⊕	68
CDC	16 poles + ⊕	69

Covers L and LG versions are not suitable to be used with code pins. If this application is required please contact ILME SpA.

housings and cover for electromagnetic compatibility

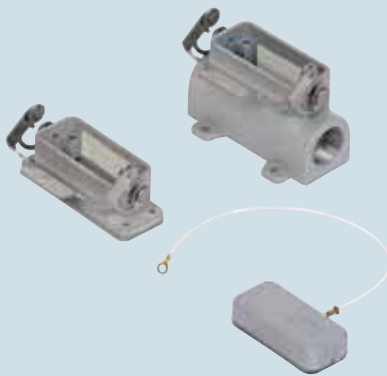

hoods and cover for electromagnetic compatibility



description	part No.		entry		part No.		entry	
			Pg	M			Pg	M
bulkhead housing, with lever	CZIS 25 L	---						
surface housing, with lever, high construction	CZAPS 25 L2	16 x 2	MZAPS 25L225	25 x 2				
cover with pegs (for enclosures with lever)	CZCS 25 L							
with pegs, side entry					CZOS 25 L	16	MZOS 25 L20	20
with pegs, side entry					CZOS 25 L25		MZOS 25 L25	25
with pegs, side entry, high construction					CZAOS 25 L21	21	MZAOS 25 L25	25
with pegs, top entry					CZVS 25 L	16	MZVS 25 L20*	20
with pegs, top entry, high construction					CZAVS 25 L21	21	MZAVS 25 L25	25
cover with lever (for enclosures with pegs)					CZCS 25 LG			

panel cut-out for bulkhead mounting housings in mm

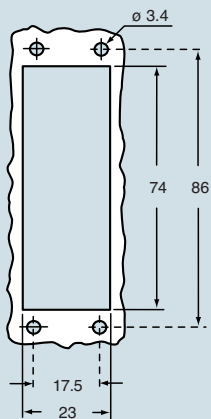

* to be used only with cable gland (to be ordered separately).

dimensions in mm

CZIS L

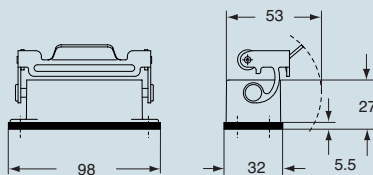

CZAPS L and MZAPS L

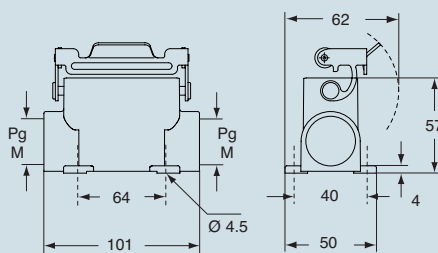

CZCS L

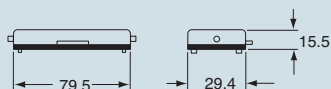

dimensions in mm

CZOS L and MZOS L

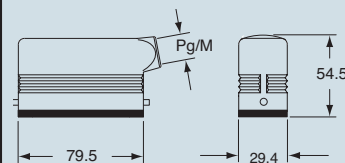

CZAOS L - MZAOS L and CZAVS L - MZAVS L

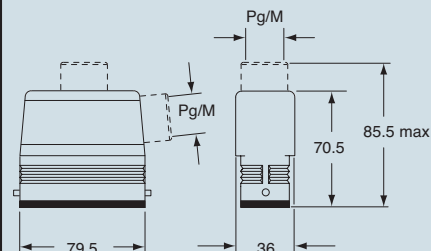

CZVS L and MZVS L

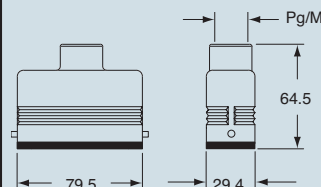

CZCS LG

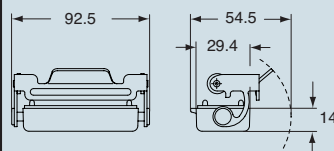

CAUS® Type 4/4X/12

dimensions indicated are not binding and may be changed without notice

size 66.16

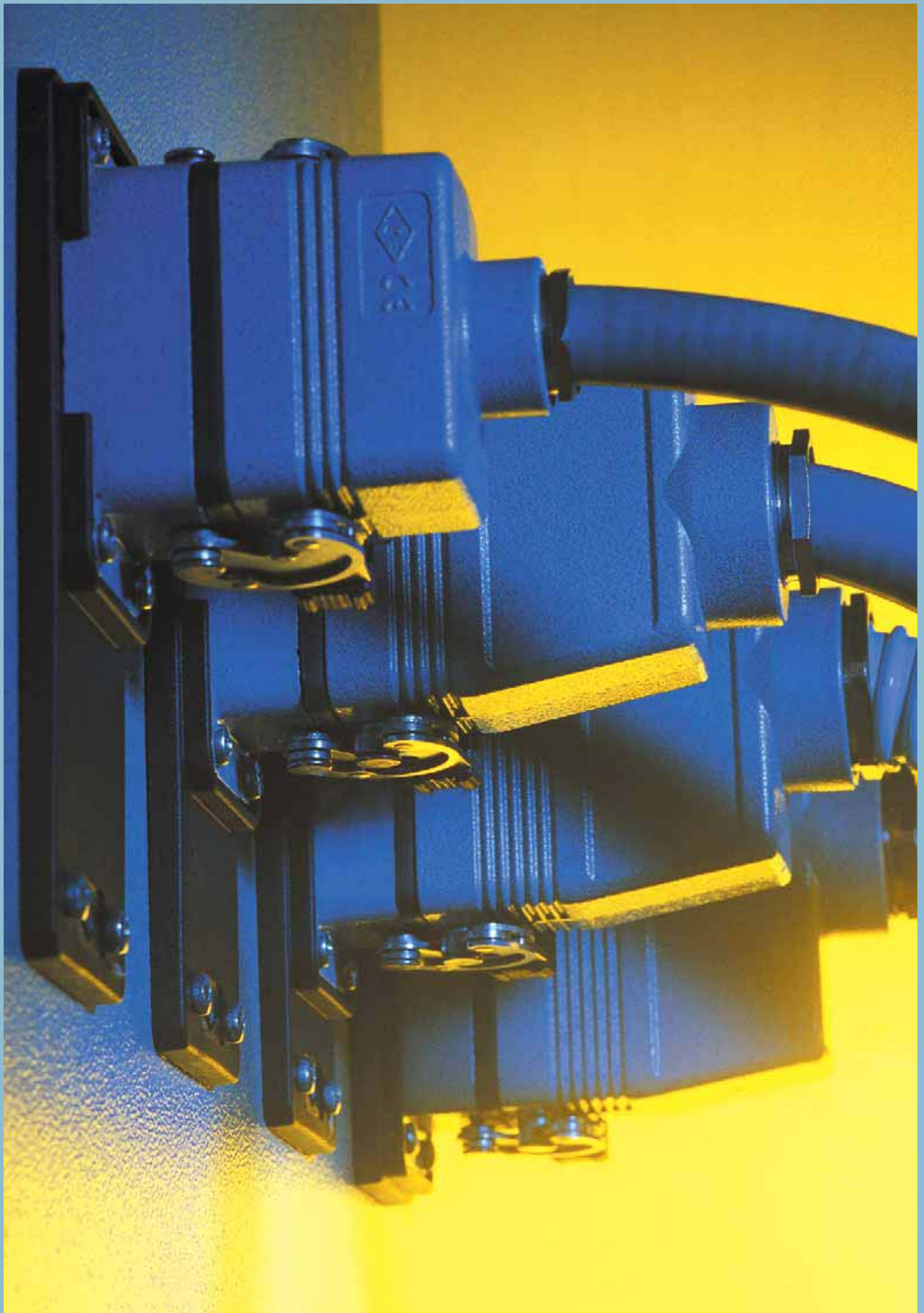



inserts:		page
CD	50 poles + ⊕	44
CDD	76 poles + ⊕	57
CDA	32 poles + ⊕	70
CDC	32 poles + ⊕	71

insert centre distance:
2 x (66 x 16) mm

bulkhead mounting housings with 2 levers or 4 pegs



surface mounting housings with 2 levers or 4 pegs



description	part No.		part No.		part No.	
				entry Pg		entry M
with levers	CHI 50					
with pegs and cover ¹⁾	CHI 50 CS					
with levers			CHP 50.21	21	MHP 50.32	32
with levers			CHP 50.221	21 x 2	MHP 50.232	32 x 2
with levers			CHP 50.29	29	MHP 50.40	40
with levers			CHP 50.229	29 x 2	MHP 50.240	40 x 2
with pegs and cover ¹⁾			CHP 50 CS	21	MHP 50 CS32	32
with pegs and cover ¹⁾			CHP 50 CS2	21 x 2	MHP 50 CS232	32 x 2
with pegs and cover ¹⁾			CHP 50 CS29	29	MHP 50 CS40	40
with pegs and cover ¹⁾			CHP 50 CS229	29 x 2	MHP 50 CS240	40 x 2

¹⁾ May be combined with hoods:
- CHO/CAO 50 X and CAV 50 X
- MHO/MAO/MFO 50 X and MAV/MFV 50 X

N.B.: the enclosures ensure IP66 protection (or IP65 cover versions) rating when mated and locked with the closing levers.
The cover (CS, CP) only ensures mechanical protection, but does not ensure IP65 protection rating.

panel cut-out for bulkhead mounting housings in mm

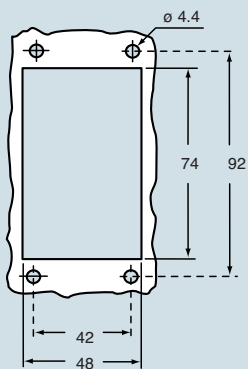

dimensions in mm

CHI

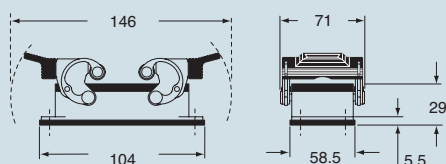

CHI CS

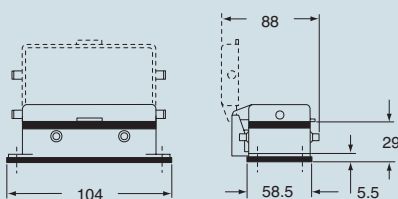

dimensions in mm

CHP and MHP

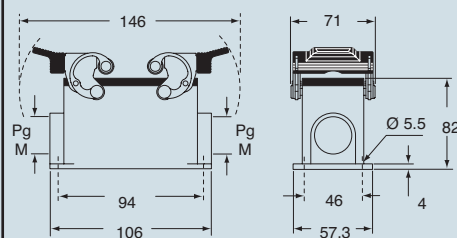

CHP CS and MHP CS

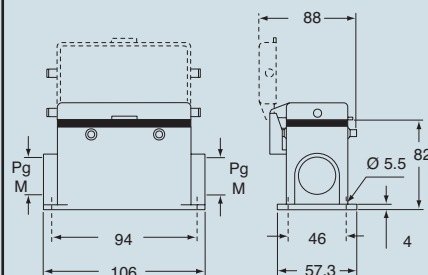

dimensions indicated are not binding and may be changed without notice

size 66.40

inserts:		page
CD	50 poles + ⊕	44
CDD	76 poles + ⊕	57
CDA	32 poles + ⊕	70
CDC	32 poles + ⊕	71

insert centre distance:
2 x (66 x 16) mm

hoods with 4 pegs



hoods with 2 levers or 4 pegs



description	hoods with 4 pegs		hoods with 2 levers or 4 pegs	
	part No.	entry Pg	part No.	entry M
with pegs, side entry	CHO 50	21	MHO 50.25	25
with pegs, side entry			MHO 50.32	32
with pegs, side entry, high construction	CAO 50.21	21	MAO 50.25	25
with pegs, side entry, high construction	CAO 50.29	29	MAO 50.32	32
with pegs, top entry, high construction			CAV 50.21	21
with pegs, top entry, high construction			CAV 50.29	29
with levers and gasket, top entry, high construction			CAV 50 G29	29
with levers and gasket, top entry, high construction			MAV 50 G32	32
with pegs, side entry, high constr., without adaptor *	CFO 50.21	21	MFO 50.25	25
with pegs, side entry, high constr., without adaptor *	CFO 50.29	29	MFO 50.32	32
with pegs, top entry, high constr., without adaptor *			CFV 50.21	21
with pegs, top entry, high constr., without adaptor *			CFV 50.29	29
with levers and gasket, top entry, high constr., without adaptor *			CFV 50 G29	29
			MFV 50 G32	32

* enclosure without adaptor, threaded on the body, to be used only with a complete cable clamp.

dimensions in mm

CHO (CAO/CFO) and MHO (MAO/MFO)

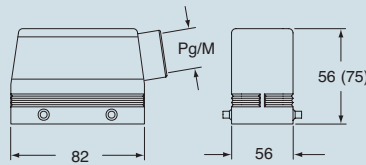

dimensions in mm

CAV (CFV) and MAV (MFV)

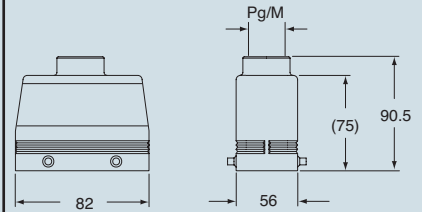

CAV G (CFV G) and MAV G (MFV G)

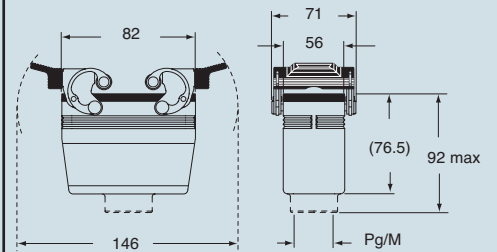

CALUS® Type 4/4X/12

dimensions indicated are not binding and may be changed without notice

size 66.40



inserts:		page
CD	50 poles + ⊕	44
CDD	76 poles + ⊕	57
CDA	32 poles + ⊕	70
CDC	32 poles + ⊕	71

insert centre distance:
2 x (66 x 16) mm

Covers CHCW 50 and CHCW 50 G versions are not suitable to be used with code pins. If this application is required please contact ILME SpA.

hoods with 2 levers



covers



description	part No.		part No.		part No.
		entry Pg		entry M	
with levers, side entry ¹⁾	CHO 50 X	21	MHO 50 X25	25	
with levers, side entry ¹⁾			MHO 50 X32	32	
with levers, side entry, high construction ¹⁾	CAO 50 X	21	MAO 50 X25	25	
with levers, side entry, high construction ¹⁾	CAO 50 X29	29	MAO 50 X32	32	
with levers, top entry, high construction ¹⁾	CAV 50 X	21	MAV 50 X25	25	
with levers, top entry, high construction ¹⁾	CAV 50 X29	29	MAV 50 X32	32	
with levers, side entry, high construction, without adaptor ^{1)*}	CFO 50 X	21	MFO 50 X25	25	
with levers, side entry, high construction, without adaptor ^{1)*}	CFO 50 X29	29	MFO 50 X32	32	
with levers, top entry, high construction, without adaptor ^{1)*}	CFV 50 X	21	MFV 50 X25	25	
with levers, top entry, high construction, without adaptor ^{1)*}	CFV 50 X29	29	MFV 50 X32	32	
cover with 4 pegs (for housings with 2 levers)					CHC 50
cover with 2 levers (for hoods with 4 pegs)					CHC 50 G

¹⁾ May be combined with housings:
- CHI 50 CS, CHP 50 CS and MHP 50 CS

* enclosure without adaptor, threaded on the body, to be used only with a complete cable clamp.

dimensions in mm

CHO X (CAO X/CFO X) and MHO X (MAO X/MFO X)

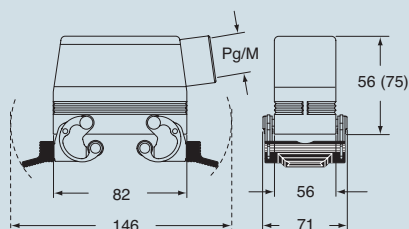

CAV X (CFV X) and MAV X (MFV X)

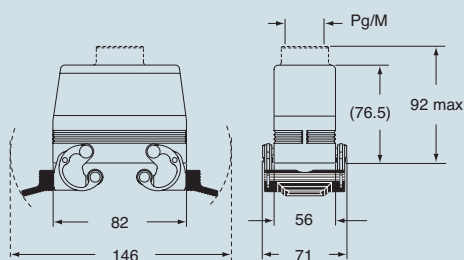

dimensions in mm

CHC



CHC G

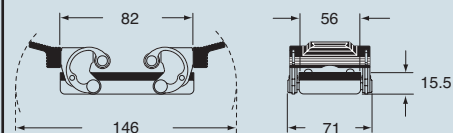

dimensions indicated are not binding and may be changed without notice

size 66.40

inserts:		page
CD	50 poles + ⊕	44
CDD	76 poles + ⊕	57
CDA	32 poles + ⊕	70
CDC	32 poles + ⊕	71

insert centre distance:
2 x (66 x 16) mm

Covers CHCW 50 and CHCW 50 G versions are not suitable to be used with code pins. If this application is required please contact ILME SpA.

housings and cover

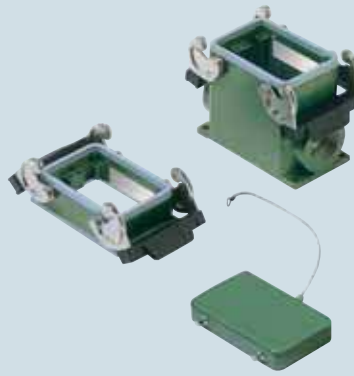

hoods and cover



description	part No.		part No.		part No.		part No.	
	entry Pg	entry M	entry Pg	entry M	entry Pg	entry M	entry Pg	entry M
bulkhead housing, with levers	CHIW 50	--	MHPW 50.32	32				
surface housing, with levers	CHPW 50.21	21	MHPW 50.250	50 x 2				
surface housing, with levers	CHPW 50.229	29 x 2						
cover with 4 pegs (for housings with 2 levers)	CHCW 50							
with pegs, side entry					CHOW 50	21	MHOW 50.25	25
with pegs, side entry							MHOW 50.32	32
with pegs, side entry, high construction					CAOW 50.29	29	MAOW 50.32	32
with pegs, top entry, high construction					CAVW 50.29	29	MAVW 50.32	32
cover with 2 levers (for hoods with 4 pegs)	CHCW 50 G							

panel cut-out for bulkhead mounting housings in mm

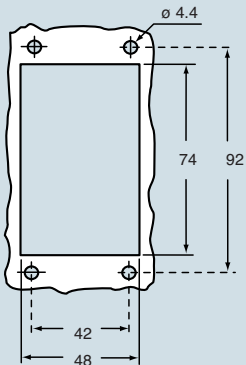

dimensions in mm

CHIW

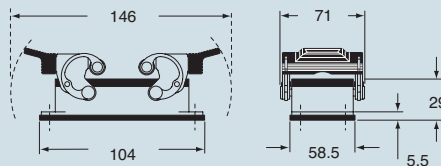

CHPW and MHPW

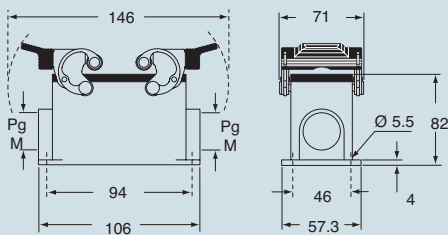

CHCW



dimensions in mm

CHOW (CAOW) and MHOW (MAOW)

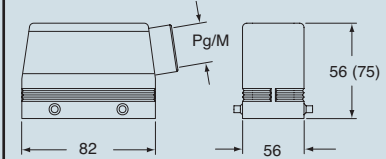

CAVW and MAVW

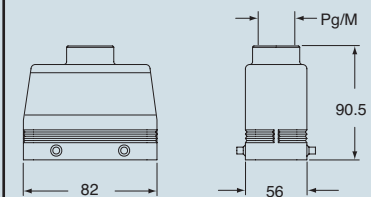

CHCW G

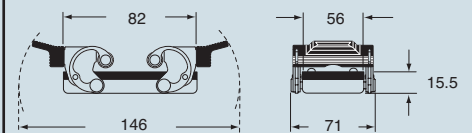

dimensions indicated are not binding and may be changed without notice

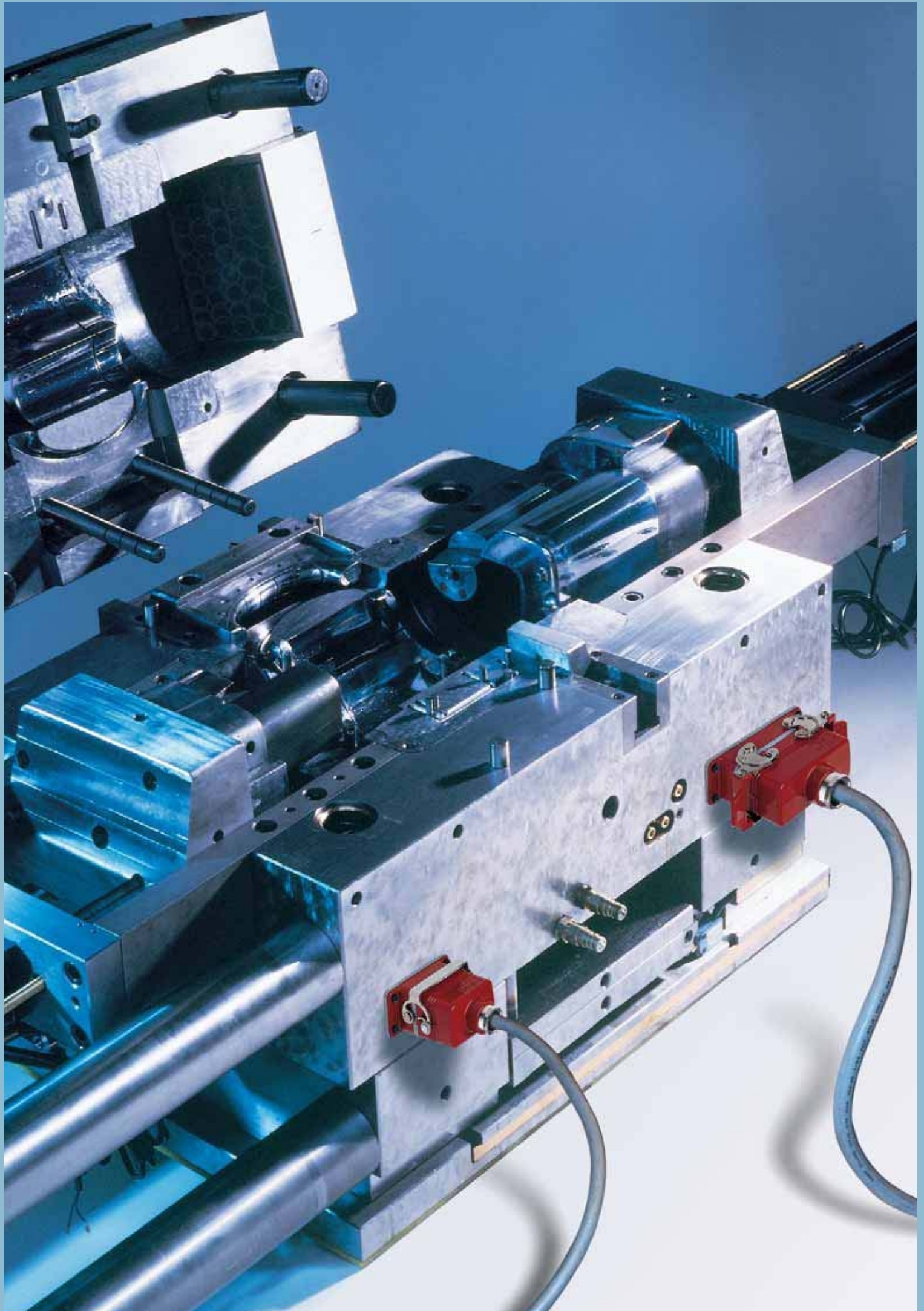



inserts:		page
CDD	24 poles + ⊕	53
CQE	10 poles + ⊕	74
CN	6 poles + ⊕	80
CCE	6 poles + ⊕	86
CNE, CSE	6 poles + ⊕	87
CSS	6 poles + ⊕	98
CTE, CTSE	6 poles + ⊕	106
MIXO	2 modules	137-151

insert centre distance:
44 x 27 mm

bulkhead mounting housings with single lever



bulkhead mounting housings with 2 pegs



description	part No.	part No.
with lever	CHI 06 L	
with lever and cover	CHI 06 LS	
with pegs ¹⁾		CHI 06 LC
with pegs and aluminium cover ¹⁾		CHI 06 LCS
with pegs and plastic cover ¹⁾		CHI 06 LCP

¹⁾ May be combined with hoods:
- CHO/CHV 06 LX
- MHO/MHV 06 LX

N.B.: the enclosures ensure IP66 protection (or IP65 cover versions) rating when mated and locked with the closing levers.
The cover (CS, CP) only ensures mechanical protection, but does not ensure IP65 protection rating.

panel cut-out for bulkhead mounting housings in mm

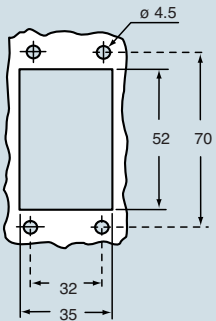

dimensions in mm

CHI L

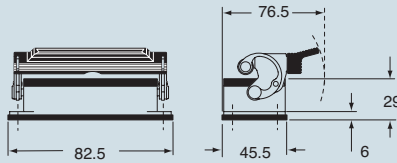

CHI LS

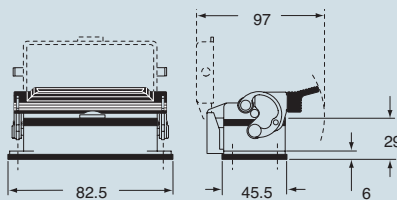

dimensions in mm

CHI LC

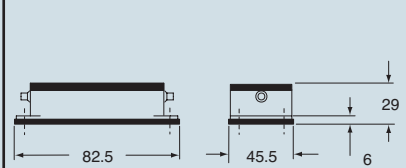

CHI LCS/LCP

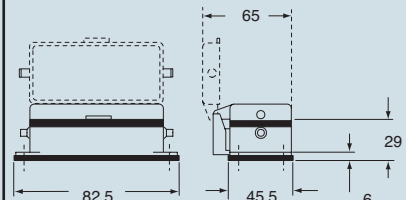

CRUS® Type 4/4X/12
(excluding enclosures with plastic cover)

dimensions indicated are not binding and may be changed without notice

size 44.27



inserts:		page
CDD	24 poles + ⊕	53
CQE	10 poles + ⊕	74
CN	6 poles + ⊕	80
CCE	6 poles + ⊕	86
CNE, CSE	6 poles + ⊕	87
CSS	6 poles + ⊕	98
MIXO	2 modules	137÷151

insert centre distance:
44 x 27 mm

surface mounting housings with single lever



description	part No.	entry Pg	part No.	entry M
	with lever	CHP 06 L	16	MHP 06 L20
with lever	CHP 06 L2	16 x 2	MHP 06 L220	20 x 2
with lever, high construction	CAP 06 L	21	MAP 06 L32	32
with lever, high construction	CAP 06 L2	21 x 2	MAP 06 L232	32 x 2
with lever, high construction	CAP 06 L29	29	MAP 06 L40	40
with lever, high construction	CAP 06 L229	29 x 2	MAP 06 L240	40 x 2
with lever and cover	CHP 06 LS	16	MHP 06 LS20	20
with lever and cover	CHP 06 LS2	16 x 2	MHP 06 LS220	20 x 2
with lever and cover, high construction	CAP 06 LS	21	MAP 06 LS32	32
with lever and cover, high construction	CAP 06 LS2	21 x 2	MAP 06 LS232	32 x 2
with lever and cover, high construction	CAP 06 LS29	29	MAP 06 LS40	40
with lever and cover, high construction	CAP 06 LS229	29 x 2	MAP 06 LS240	40 x 2

N.B.: the enclosures ensure IP66 protection (or IP65 cover versions) rating when mated and locked with the closing levers.
The cover (CS, CP) only ensures mechanical protection, but does not ensure IP65 protection rating.

dimensions in mm

CHP L - CAP L and MHP L - MAP L

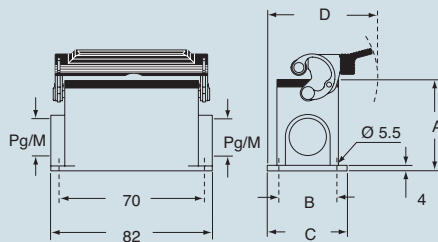

CHP LS - CAP LS and MHP LS - MAP LS

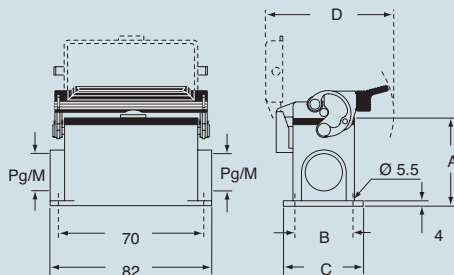

CALUS® Type 4/4X/12

type	A	B	C	D
CHP L / MHP L	53	40	52	73.5
CAP L / MAP L	74	45	57	82
CHP LS / MHP LS	53	40	52	97
CAP LS / MAP LS	74	45	57	97

dimensions indicated are not binding and may be changed without notice

size 44.27



inserts:		page
CDD	24 poles + ⊕	53
CQE	10 poles + ⊕	74
CN	6 poles + ⊕	80
CCE	6 poles + ⊕	86
CNE, CSE	6 poles + ⊕	87
CSS	6 poles + ⊕	98
MIXO	2 modules	137÷151

insert centre distance:
44 x 27 mm

hoods with 2 pegs



hoods with single lever



description	part No.		part No.		part No.		part No.	
		entry Pg		entry M		entry Pg		entry M
with pegs, side entry	CHO 06 L13	13,5	MHO 06 L20	20				
with pegs, side entry	CHO 06 L16	16	MHO 06 L25	25				
with pegs, side entry, high construction	CAO 06 L21	21	MAO 06 L25	25				
with pegs, side entry, high construction	CAO 06 L29	29	MAO 06 L32	32				
with pegs, side entry, high construction, without adaptor *	CFO 06 L21	21	MFO 06 L25	25				
with pegs, side entry, high construction, without adaptor *	CFO 06 L29	29	MFO 06 L32	32				
with pegs, top entry	CHV 06 L13	13,5	MHV 06 L20	20				
with pegs, top entry	CHV 06 L16	16	MHV 06 L25	25				
with pegs, top entry, high construction	CAV 06 L21	21	MAV 06 L25	25				
with pegs, top entry, high construction	CAV 06 L29	29	MAV 06 L32	32				
with pegs, top entry, high construction, without adaptor *	CFV 06 L21	21	MFV 06 L25	25				
with pegs, top entry, high construction, without adaptor *	CFV 06 L29	29	MFV 06 L32	32				
with lever, top entry					CHV 06 LG	16	MHV 06 LG25	25
with lever, top entry, high construction					CAV 06 LG21	21	MAV 06 LG25	25
with lever, top entry, high construction					CAV 06 LG29	29	MAV 06 LG32	32
with lever, top entry, high constr., without adaptor *					CFV 06 LG21	21	MFV 06 LG25	25
with lever, top entry, high constr., without adaptor *					CFV 06 LG29	29	MFV 06 LG32	32

* enclosure without adaptor, threaded on the body, to be used only with a complete cable clamp.

dimensions in mm

CHO L (CAO L) and (CFO L)
MHO L (MAO L) and (MFO L)

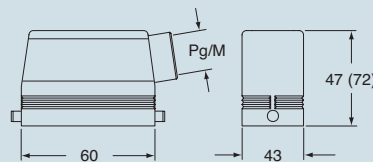

CHV L (CAV L) and [CFV L]
MHV L (MAV L) and [MFV L]

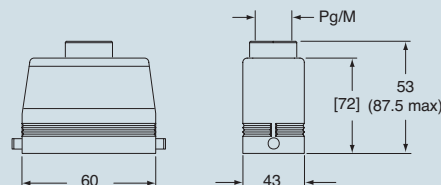

dimensions in mm

CHV LG (CAV LG) and [CFV LG]
MHV LG (MAV LG) and [MFV LG]

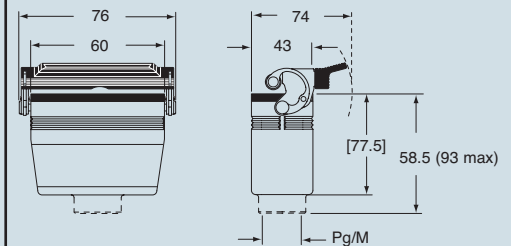

CALUS® Type 4/4X/12

dimensions indicated are not binding and may be changed without notice



inserts:		page
CDD	24 poles + ⊕	53
CQE	10 poles + ⊕	74
CN	6 poles + ⊕	80
CCE	6 poles + ⊕	86
CNE, CSE	6 poles + ⊕	87
CSS	6 poles + ⊕	98
CTE, CTSE	6 poles + ⊕	106
MIXO	2 modules	137÷151

insert centre distance:
44 x 27 mm

hoods with single lever



covers

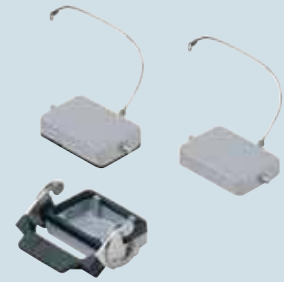

description	part No.		part No.		part No.
		entry Pg		entry M	
with lever, without gasket, side entry ¹⁾	CHO 06 LX16	16	MHO 06 LX20	20	
with lever, without gasket, side entry ¹⁾			MHO 06 LX25	25	
with lever, without gasket, top entry ¹⁾	CHV 06 LX16	16	MHV 06 LX20	20	
with lever, without gasket, top entry ¹⁾			MHV 06 LX25	25	
with lever (for hoods with pegs)					CHC 06 LG
with pegs (for housings with lever)					CHC 06 L
with pegs and gasket (for hoods with lever) ²⁾					CHC 06 LC

¹⁾ May be combined with housings: CHI 06 LCS/LCP/LC

²⁾ May be combined with housings:
- CHO/CHV 06 LX
- MHO/MHV 06 LX

dimensions in mm

CHO LX and MHO LX

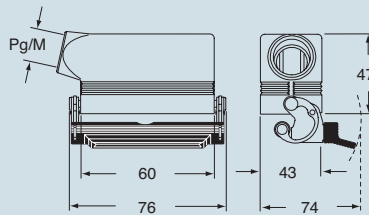

CHV LX and MHV LX

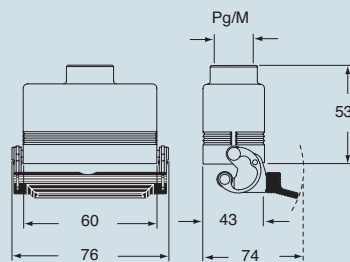

dimensions in mm

CHC LG

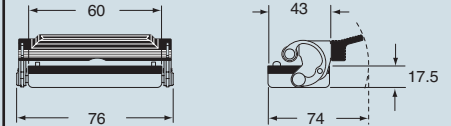

CHC L

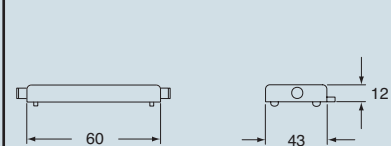

CHC LC

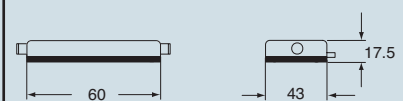

CALUS® Type 4/4X/12

dimensions indicated are not binding and may be changed without notice

size 44.27



inserts:	page
CN RY 6 poles + ⊕	80
CNE RY 6 poles + ⊕	87

insert centre distance:
44 x 27 mm

housings and cover

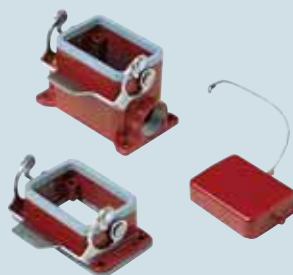

hoods and cover



description	part No.		part No.		part No.		part No.	
		entry Pg		entry M		entry Pg		entry M
bulkhead housing with lever	CZIR 06 L	---						
surface housing with lever	CZPR 06 L	16	MZPR 06 L20	20				
surface housing with lever, high construction	CZAPR 06 L	21	MZAPR 06 L32	32				
cover with pegs (for housings)	CHCR 06 L	---						
with pegs, side entry					CHOR 06 L13	13.5	MHOR 06 L20	20
with pegs, side entry, high construction					CAOR 06 L21	21	MAOR 06 L32	32
with pegs, top entry					CHVR 06 L13	13.5	MHVR 06 L20	20
with pegs, top entry, high construction					CAVR 06 L21	21	MAVR 06 L32	32
cover with lever (for hoods)					CZCR 06 LG	---		

panel cut-out for bulkhead mounting housings in mm

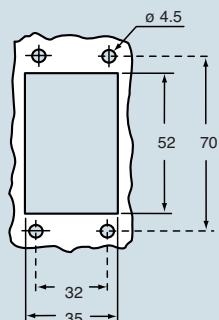

dimensions in mm

CZIR L

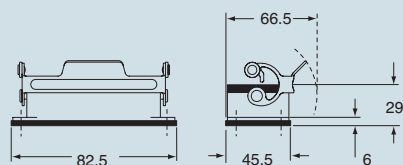

CZPR L - CZAPR L and MZPR L - MZAPR L

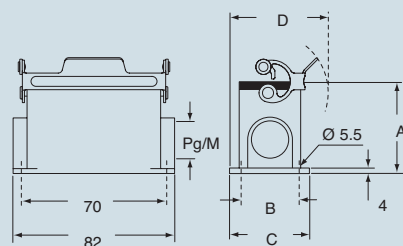

CHCR L

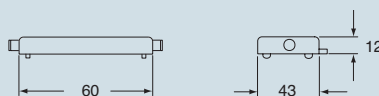

dimensions in mm

CHOR L (CAOR L) and MHOR L (MAOR L)

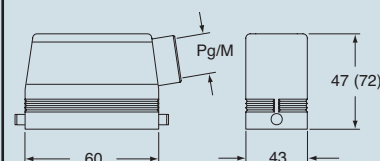

CHVR L (CAVR L) and MHVR L (MAVR L)

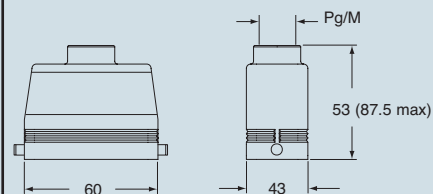

CZCR LG

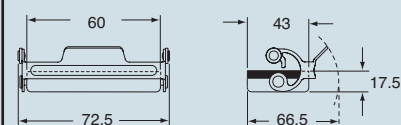

CALUS® Type 4/4X/12

type	A	B	C	D
CZPR L / MZPR L	53	40	52	69.5
CZAPR L / MZAPR L	74	45	57	72

dimensions indicated are not binding and may be changed without notice

size 44,27



inserts:		page
CDD	24 poles + ⊕	53
CQE	10 poles + ⊕	74
CN	6 poles + ⊕	80
CCE	6 poles + ⊕	86
CNE, CSE	6 poles + ⊕	87
CSS	6 poles + ⊕	98
CTE, CTSE *)	6 poles + ⊕	106
MIXO	2 modules	137-151

insert centre distance:
44 x 27 mm

*) only for enclosure CHIW 06 L

housings and cover



hoods and cover



description	part No.		part No.		part No.		part No.	
		entry Pg		entry M		entry Pg		entry M
bulkhead housing with lever	CHIW 06 L	---						
surface housing with lever, high construction	CAPW 06 L	21	MAPW 06 L32	32				
cover with pegs (for enclosures with lever)	CHCW 06 L							
with pegs, side entry, high construction					CAOW 06 L21	21	MAOW 06 L32	32
with pegs, top entry, high construction					CAVW 06 L21	21	MAVW 06 L32	32
cover with lever (for enclosures with pegs)					CHCW 06 LG			
with lever and gasket, top entry, high construction					CAVW 06 LG	21	MAVW 06 LG32	32

panel cut-out for bulkhead mounting housings in mm

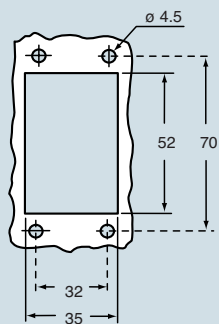

dimensions in mm

CHIW L

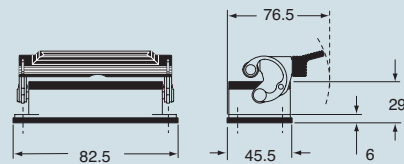

CAPW L and MAPW L

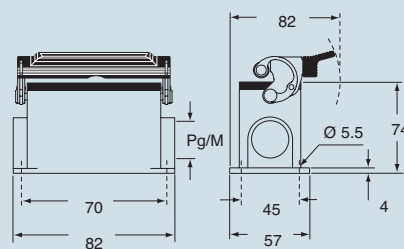

CHCW L

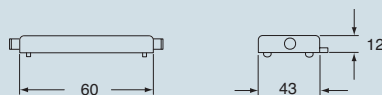

dimensions in mm

CAOW L and MAOW L

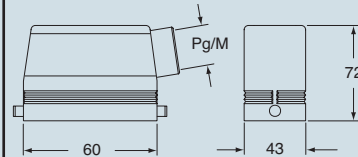

CAVW L and MAVW L

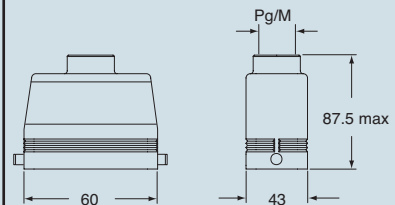

CHCW LG

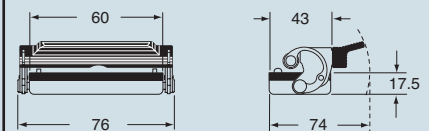

CAVW LG and MAVW LG

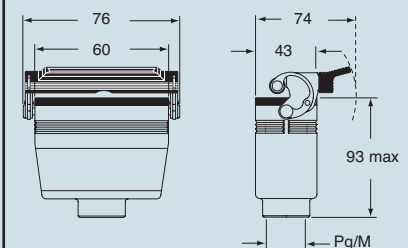

CAVUS® Type 4/4X/12

dimensions indicated are not binding and may be changed without notice

size 44.27



inserts:		page
CDD	24 poles + ⊕	53
CQE	10 poles + ⊕	74
CN	6 poles + ⊕	80
CCE	6 poles + ⊕	86
CNE, CSE	6 poles + ⊕	87
CSS	6 poles + ⊕	98
CTE, CTSE *)	6 poles + ⊕	106
MIXO	2 modules	137÷151

insert centre distance:
44 x 27 mm

*) only for enclosure CHIS 06 L

housings and cover
for electromagnetic compatibility



hoods and cover
for electromagnetic compatibility



description	part No.		part No.		part No.		part No.	
	entry Pg	entry M	entry Pg	entry M	entry Pg	entry M	entry Pg	entry M
bulkhead housing with lever	---	---	---	---	---	---	---	---
surface housing with lever, high construction	21	32	---	---	---	---	---	---
cover with pegs (for enclosures with lever)	---	---	---	---	---	---	---	---
with pegs, side entry, high construction	---	---	---	---	21	32	---	---
with pegs, top entry, high construction	---	---	---	---	21	32	---	---
cover with lever (for enclosures with pegs)	---	---	---	---	---	---	---	---

panel cut-out for bulkhead mounting housings in mm

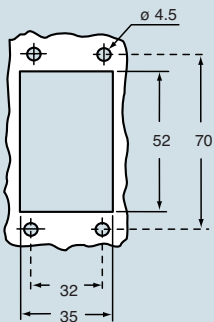

dimensions in mm

CHIS L

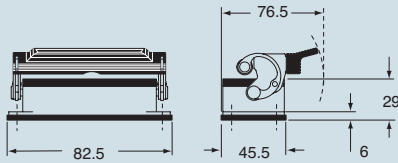

CAPS L and MAPS L

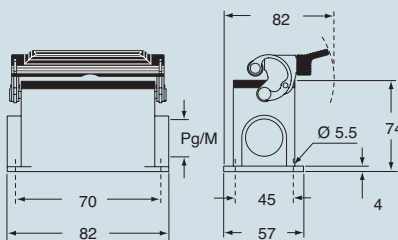

CHCS L

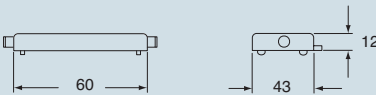

dimensions in mm

CAOS L and MAOS L

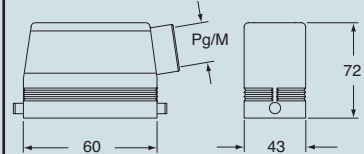

CAVS L and MAVS L

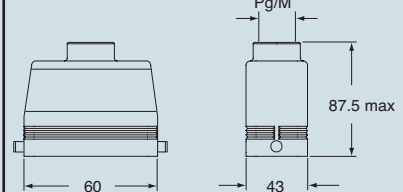

CHCS LG

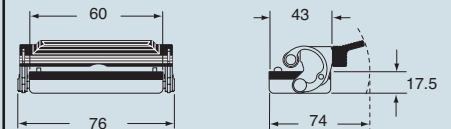

CRUS® Type 4/4X/12

dimensions indicated are not binding and may be changed without notice

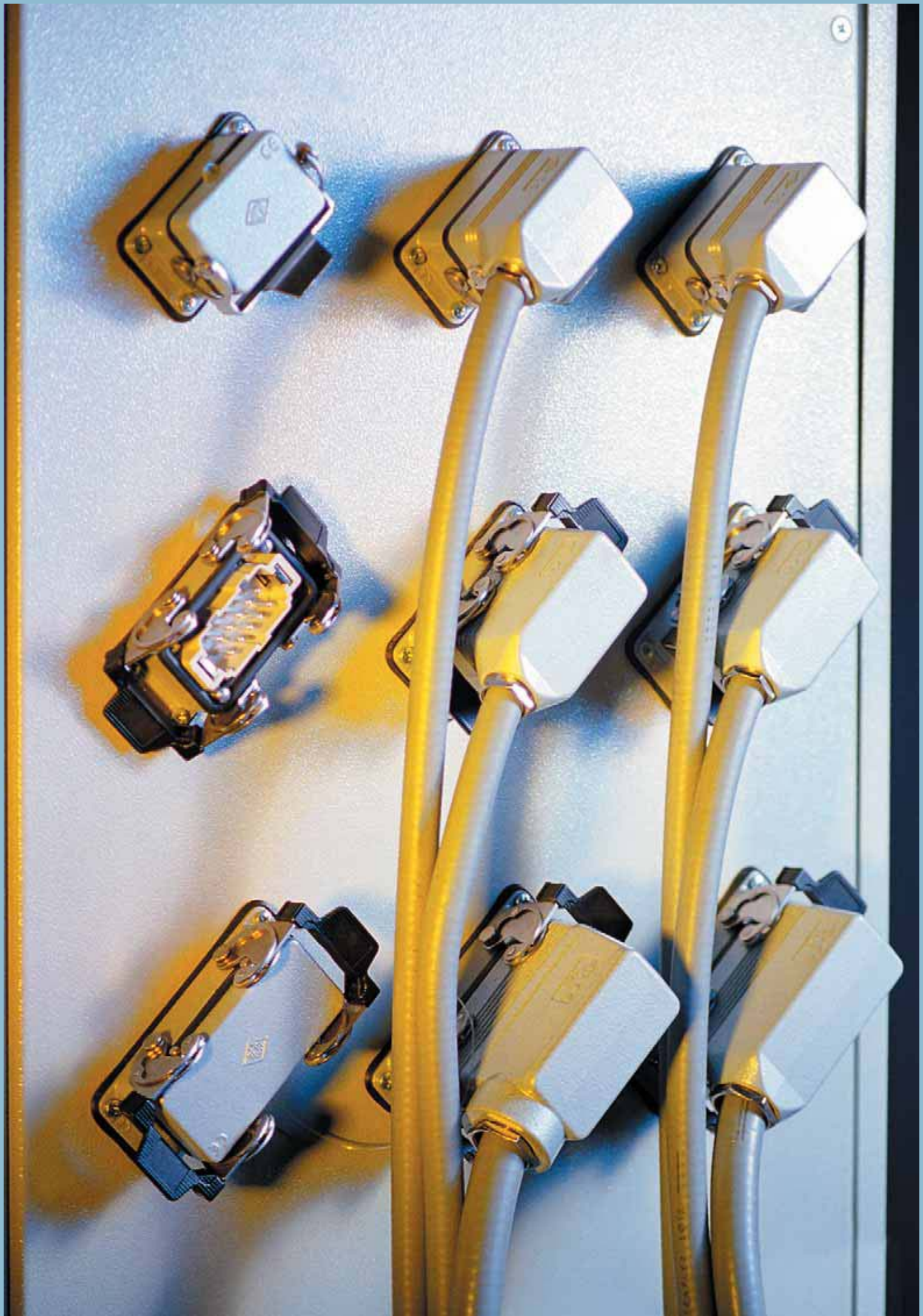



inserts:		page
CDD	42 poles + ⊕	55
CQE	18 poles + ⊕	75
CN	10 poles + ⊕	81
CCE	10 poles + ⊕	88
CNE, CSE	10 poles + ⊕	89
CSS	10 poles + ⊕	100
CTE, CTSE	10 poles + ⊕	107
CMSE	3+2 (aux) poles + ⊕	114
CMCE	3+2 (aux) poles + ⊕	114
CX	8/24 poles + ⊕	129
MIXO	3 modules	137÷151

insert centre distance:
57 x 27 mm

bulkhead mounting housings with 2 levers or 4 pegs



bulkhead mounting housings with single lever



description	part No.	part No.
with lever/s	CHI 10	CHI 10 L
with pegs ¹⁾	CHI 10 C	
with pegs and aluminium cover ¹⁾	CHI 10 CS	
with pegs and plastic cover ¹⁾	CHI 10 CP	
with lever and cover		CHI 10 LS

¹⁾ May be combined with hoods:
- CHO/CAO 10 X and CHV/CAV 10 X
- MHO/MAO 10 X and MHV/MAV 10 X

N.B.: the enclosures ensure IP66 protection (or IP65 cover versions) rating when mated and locked with the closing levers.
The cover (CS, CP) only ensures mechanical protection, but does not ensure IP65 protection rating.

panel cut-out for bulkhead mounting housings in mm

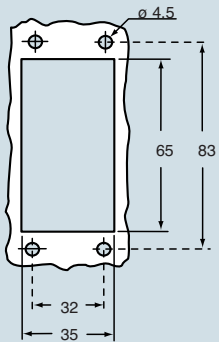

dimensions in mm

CHI

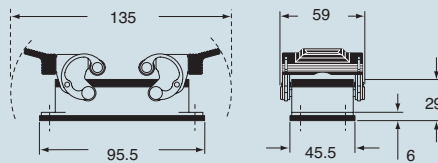

CHI C

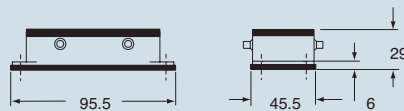

CHI CS/CP

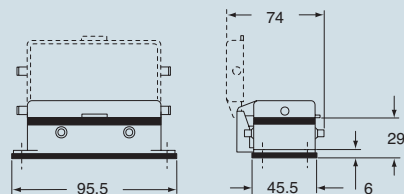

dimensions in mm

CHI L

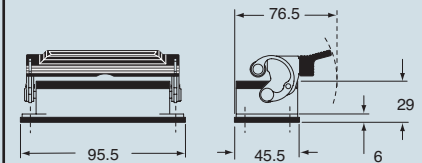

CHI LS

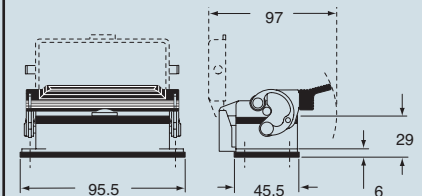

CAVUS® Type 4/4X/12

(excluding enclosures with plastic cover)

dimensions indicated are not binding and may be changed without notice

size 57.27



inserts:	page
CDD 42 poles + ⊕	55
CQE 18 poles + ⊕	75
CN 10 poles + ⊕	81
CCE 10 poles + ⊕	88
CNE, CSE..... 10 poles + ⊕	89
CSS 10 poles + ⊕	100
CMSE 3+2 (aux) poles + ⊕	114
CMCE 3+2 (aux) poles + ⊕	114
CX 8/24 poles + ⊕	129
MIXO 3 modules	137÷151

insert centre distance:
57 x 27 mm

surface mounting housings with 2 levers or 4 pegs



surface mounting housings with single lever



description	part No.		part No.		part No.		part No.	
	entry Pg	entry M	entry Pg	entry M	entry Pg	entry M	entry Pg	entry M
with levers	CHP 10	16	MHP 10.20	20	CHP 10 L	16	MHP 10 L20	20
with levers	CHP 10.2	16 x 2	MHP 10.220	20 x 2	CHP 10 L2	16 x 2	MHP 10 L220	20 x 2
with levers, high construction	CAP 10.21	21	MAP 10.32	32	CAP 10 L	21	MAP 10 L32	32
with levers, high construction	CAP 10.221	21 x 2	MAP 10.232	32 x 2	CAP 10 L2	21 x 2	MAP 10 L232	32 x 2
with levers, high construction	CAP 10.29	29	MAP 10.40	40	CAP 10 L29	29	MAP 10 L40	40
with levers, high construction	CAP 10.229	29 x 2	MAP 10.240	40 x 2	CAP 10 L229	29 x 2	MAP 10 L240	40 x 2
with pegs and aluminium cover ¹⁾	CHP 10 CS	16	MHP 10 CS20	20				
with pegs and aluminium cover ¹⁾	CHP 10 CS2	16 x 2	MHP 10 CS220	20 x 2				
with pegs and aluminium cover, high construction ¹⁾	CAP 10 CS	21	MAP 10 CS32	32				
with pegs and aluminium cover, high construction ¹⁾	CAP 10 CS2	21 x 2	MAP 10 CS232	32 x 2				
with pegs and aluminium cover, high construction ¹⁾	CAP 10 CS29	29	MAP 10 CS40	40				
with pegs and aluminium cover, high construction ¹⁾	CAP 10 CS229	29 x 2	MAP 10 CS240	40 x 2				
with pegs and plastic cover ¹⁾	CHP 10 CP	16	MHP 10 CP20	20				
with pegs and plastic cover ¹⁾	CHP 10 CP2	16 x 2	MHP 10 CP220	20 x 2				
with pegs and plastic cover, high construction ¹⁾	CAP 10 CP	21	MAP 10 CP32	32				
with pegs and plastic cover, high construction ¹⁾	CAP 10 CP2	21 x 2	MAP 10 CP232	32 x 2				
with pegs and plastic cover, high construction ¹⁾	CAP 10 CP29	29	MAP 10 CP40	40				
with pegs and plastic cover, high construction ¹⁾	CAP 10 CP229	29 x 2	MAP 10 CP240	40 x 2				
with lever and cover					CHP 10 LS	16	MHP 10 LS20	20
with lever and cover					CHP 10 LS2	16 x 2	MHP 10 LS220	20 x 2
with lever and cover, high construction					CAP 10 LS	21	MAP 10 LS32	32
with lever and cover, high construction					CAP 10 LS2	21 x 2	MAP 10 LS232	32 x 2
with lever and cover, high construction					CAP 10 LS29	29	MAP 10 LS40	40
with lever and cover, high construction					CAP 10 LS229	29 x 2	MAP 10 LS240	40 x 2

¹⁾ May be combined with hoods:
- CHO/CAO 10 X and CHV/CAV 10 X
- MHO/MAO 10 X and MHV/MAV 10 X

N.B.: the enclosures ensure IP66 protection (or IP65 cover versions) rating when mated and locked with the closing levers.
The cover (CS, CP) only ensures mechanical protection, but does not ensure IP65 protection rating.

dimensions in mm
CHP - CAP and MHP - MAP

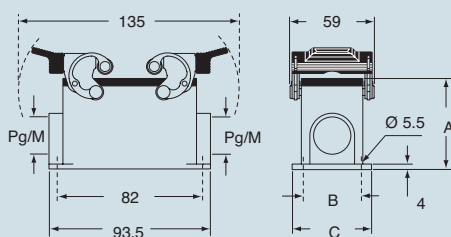

CHP CS/CP - CAP CS/CP and MHP CS/CP - MAP CS/CP

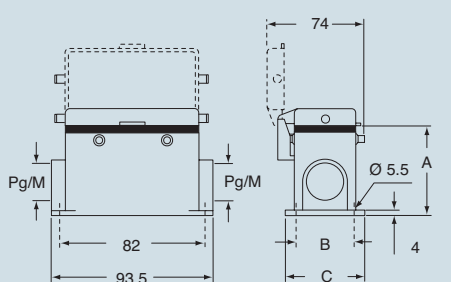

type	A	B	C
CHP / MHP	57	40	52
CAP / MAP	74	45	57
CHP CS / MHP CS	57	40	52
CAP CS / MAP CS	74	45	57
CHP CP / MHP CP	57	40	52
CAP CP / MAP CP	74	45	57

dimensions in mm
CHP L - CAP L and MHP L - MAP L

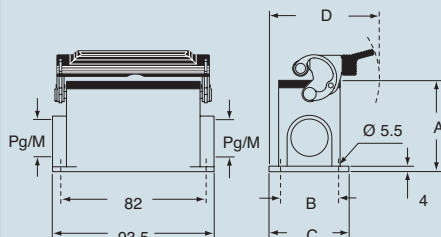

CHP LS - CAP LS and MHP LS - MAP LS

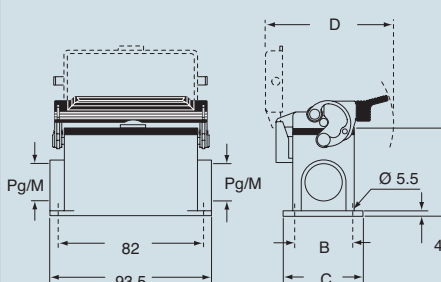

type	A	B	C	D
CHP L / MHP L	57	40	52	79.5
CAP L / MAP L	74	45	57	82
CHP LS / MHP LS	57	40	52	97
CAP LS / MAP LS	74	45	57	97

CAVUS® Type 4/4X/12

(excluding enclosures with plastic cover)

dimensions indicated are not binding and may be changed without notice

size 57.27



inserts:		page
CDD	42 poles + ⊕	55
CQE	18 poles + ⊕	75
CN	10 poles + ⊕	81
CCE	10 poles + ⊕	88
CNE, CSE	10 poles + ⊕	89
CSS	10 poles + ⊕	100
CMSE	3+2 (aux) poles + ⊕	114
CMCE	3+2 (aux) poles + ⊕	114
CX	8/24 poles + ⊕	129
MIXO	3 modules	137÷151

insert centre distance:
57 x 27 mm

hoods with 4 pegs



hoods with 2 pegs



description	part No.		entry		part No.		entry	
			Pg	M			Pg	M
with pegs, side entry	CHO 10		16		MHO 10.20		20	
with pegs, side entry					MHO 10.25		25	
with pegs, side entry, high construction	CAO 10.21		21		MAO 10.32		32	
with pegs, side entry, high construction	CAO 10.29		29		MAO 10.40		40	
with pegs, top entry	CHV 10		16		MHV 10.20 **		20	
with pegs, top entry					MHV 10.25		25	
with pegs, top entry, high construction	CAV 10.21		21		MAV 10.32		32	
with pegs, top entry, high construction	CAV 10.29		29		MAV 10.40		40	
with pegs, frontal entry, high construction	CAF 10		16		MAF 10.20		20	
with pegs, frontal entry, high constr., without adaptor *	CFF 10		16		MFF 10.20		20	

* enclosure without adaptor, threaded on the body, to be used only with a complete cable clamp.

** can only be used with a complete cable clamp (to be purchased separately)

dimensions in mm

CHO (CAO) and MHO (MAO)

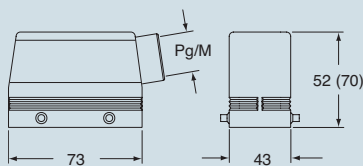

dimensions in mm

CHO L (CAO L) and MHO L (MAO L)

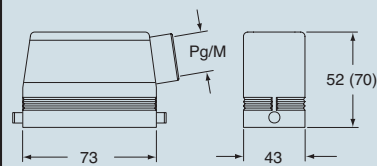

CHV (CAV) and MHV (MAV)

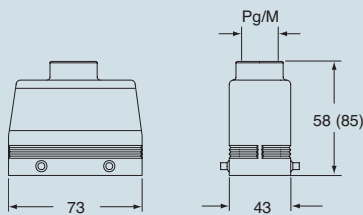

CHV L (CAV L) and MHV L (MAV L)

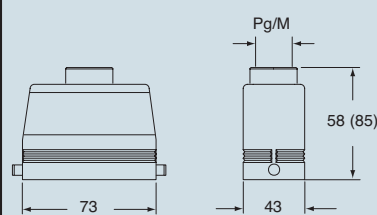

CAF/CFF and MAF/MFF

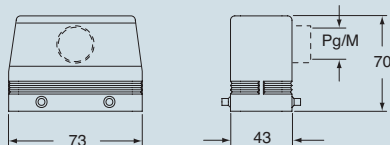

CALUS® Type 4/4X/12

dimensions indicated are not binding and may be changed without notice

size 57.27



inserts:		page
CDD	42 poles + ⊕	55
CQE	18 poles + ⊕	75
CN	10 poles + ⊕	81
CCE	10 poles + ⊕	88
CNE, CSE	10 poles + ⊕	89
CSS	10 poles + ⊕	100
CMSE	3+2 (aux) poles + ⊕	114
CMCE	3+2 (aux) poles + ⊕	114
CX	8/24 poles + ⊕	129
MIXO	3 modules	137÷151

insert centre distance:
57 x 27 mm

hoods with 2 levers



hoods with single lever



description	part No.		entry Pg		part No.		entry M	
with levers and gasket, top entry	CHV 10 G	16	MHV 10 G25	25	CHV 10 LG	16	MHV 10 LG25	25
with levers and gasket, top entry, high construction	CAV 10 G	21	MAV 10 G25	25	CAV 10 LG21	21	MAV 10 LG25	25
with levers and gasket, top entry, high construction	CAV 10 G29	29	MAV 10 G32	32	CAV 10 LG29	29	MAV 10 LG32	32
with levers and gasket, top entry, high constr., without adaptor *	CFV 10 G	21	MFV 10 G25	25	CFV 10 LG21	21	MFV 10 LG25	25
with levers and gasket, top entry, high constr., without adaptor *	CFV 10 G29	29	MFV 10 G32	32	CFV 10 LG29	29	MFV 10 LG32	32

* enclosure without adaptor, threaded on the body, to be used only with a complete cable clamp.

dimensions in mm

**CHV G (CAV G) and [CFV G],
MHV G (MAV G) and [MFV G]**

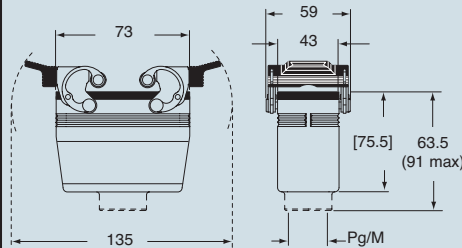

dimensions in mm

**CHV LG (CAV LG) and [CFV LG],
MHV LG (MAV LG) and [MFV LG]**

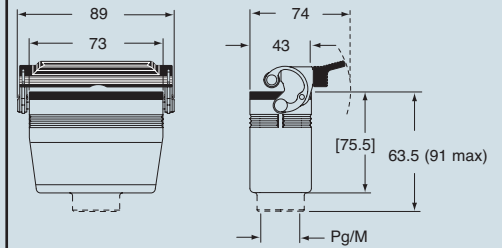

CALUS® Type 4/4X/12

dimensions indicated are not binding and may be changed without notice

size 57.27



inserts:		page
CDD	42 poles + ⊕	55
CQE	18 poles + ⊕	75
CN	10 poles + ⊕	81
CCE	10 poles + ⊕	88
CNE, CSE.....	10 poles + ⊕	89
CSS	10 poles + ⊕	100
CMSE	3+2 (aux) poles + ⊕	114
CMCE	3+2 (aux) poles + ⊕	114
CX	8/24 poles + ⊕	129
MIXO	3 modules	137÷151

insert centre distance: 57 x 27 mm

The covers for C, G and LG versions cannot be used together with coding pins. If this application is required, please contact ILME SpA.

hoods with 2 levers



covers



description	part No.		part No.		part No.	
		entry Pg		entry M		
with levers, side entry ¹⁾	CHO 10 X	16	MHO 10 X20	20		
with levers, side entry ¹⁾			MHO 10 X25	25		
with levers, side entry, high construction ¹⁾	CAO 10 X	21	MAO 10 X32	32		
with levers, side entry, high construction ¹⁾	CAO 10 X29	29	MAO 10 X40	40		
with levers, top entry ¹⁾	CHV 10 X	16	MHV 10 X20 **	20		
with levers, top entry ¹⁾			MHV 10 X25	25		
with levers, top entry, high construction ¹⁾	CAV 10 X	21	MAV 10 X32	32		
with levers, top entry, high construction ¹⁾	CAV 10 X29	29	MAV 10 X40	40		
with 4 pegs (for housings with 2 levers and gasket)					CHC 10	
with 4 pegs and gasket (for housings with 2 levers) ²⁾						CHC 10 C
with 2 pegs (for housings with 1 lever and gasket)						CHC 10 L
with 2 levers (for hoods with 4 pegs)					CHC 10 G	
with 1 lever (for hoods with 2 pegs)						CHC 10 LG

¹⁾ May be combined with hoods:
- CHI/CHP/CAP 10 CS/CP/C
- MHP/MAP 10 CS/CP

²⁾ May be combined with hoods:
- CHO/CAO 10 X and CHV/CAV 10 X
- MHO/MAO 10 X and MHV/MAV 10 X

** can only be used with a complete cable clamp (to be purchased separately)

dimensions in mm

CHO X (CAO X) and MHO X (MAO X)

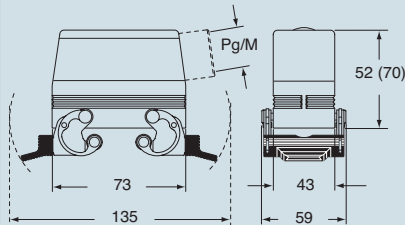

CHV X (CAV X) and MHV X (MAV X)

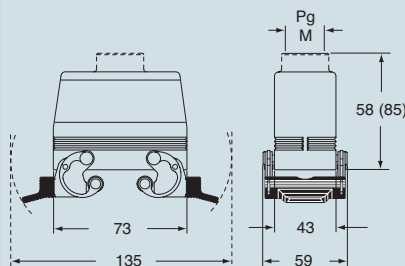

dimensions in mm

CHC



CHC C

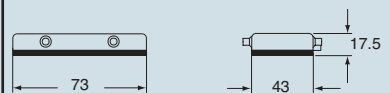

CHC L

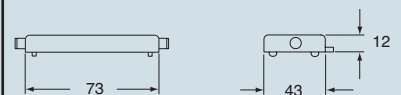

CHC G

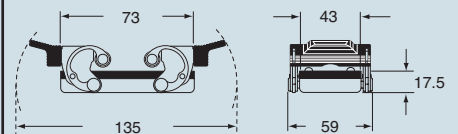

CHC LG

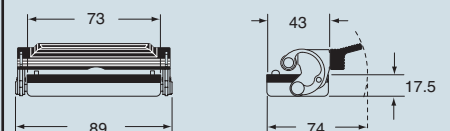

CAIUS® Type 4/4X/12

dimensions indicated are not binding and may be changed without notice

size 57.27



inserts: page
CME3 + 2 (aux) poles + ⊕ 115

insert centre distance:
57 x 27 mm

bulkhead mounting housings with 2 levers or 4 pegs



bulkhead mounting housings with single lever



description	part No.	part No.
with one or two levers	CMI 03	CMI 03 L
with pegs and aluminium cover ¹⁾	CMI 03 CS	
with pegs and plastic cover ¹⁾	CMI 03 CP	
with lever and cover		CMI 03 LS

¹⁾ May be combined with hoods:
 - CMO/CMAO 03 X e CMV/CMAV 03 X
 - MMO/MMAO 03 X e MMV/MMAV 03 X

N.B.: the enclosures ensure IP66 protection (or IP65 cover versions) rating when mated and locked with the closing levers.
 The cover (CS, CP) only ensures mechanical protection, but does not ensure IP65 protection rating.

panel cut-out for bulkhead mounting housings in mm

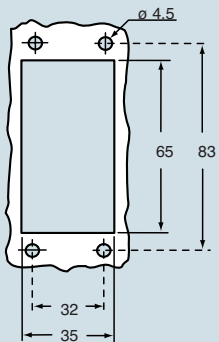

dimensions in mm

CMI

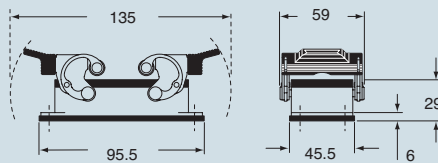

dimensions in mm

CMI L

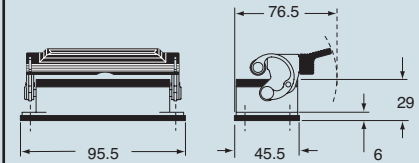

CMI CS/CP

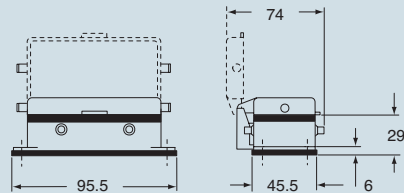

CMI LS

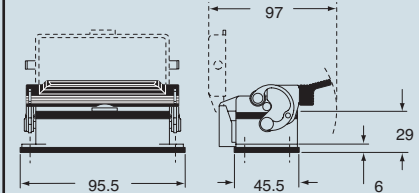

CALUS® Type 4/4X/12
 (excluding enclosures with plastic cover)

dimensions indicated are not binding and may be changed without notice

size 57.27

inserts: page
CME3 + 2 (aux) poles + ⊕ 115

insert centre distance:
57 x 27 mm

surface mounting housings with 2 levers or 4 pegs



surface mounting housings with single lever



description	part No.	entry Pg	part No.	entry M	part No.	entry Pg	part No.	entry M
with levers	CMP 03	16	MMP 03.20	20	CMP 03 L	16	MMP 03 L20	20
with levers	CMP 03.2	16 x 2	MMP 03.220	20 x 2	CMP 03 L2	16 x 2	MMP 03 L220	20 x 2
with levers, high construction	CMAP 03.21	21	MMAP 03.32	32	CMAP 03 L	21	MMAP 03 L32	32
with levers, high construction	CMAP 03.221	21 x 2	MMAP 03.232	32 x 2	CMAP 03 L2	21 x 2	MMAP 03 L232	32 x 2
with levers, high construction	CMAP 03.29	29	MMAP 03.40	40	CMAP 03 L29	29	MMAP 03 L40	40
with levers, high construction	CMAP 03.229	29 x 2	MMAP 03.240	40 x 2	CMAP 03 L229	29 x 2	MMAP 03 L240	40 x 2
with pegs and aluminium cover ¹⁾	CMP 03 CS	16	MMP 03 CS20	20				
with pegs and aluminium cover ¹⁾	CMP 03 CS2	16 x 2	MMP 03 CS220	20 x 2				
with pegs and aluminium cover, high construction ¹⁾	CMAP 03 CS	21	MMAP 03 CS32	32				
with pegs and aluminium cover, high construction ¹⁾	CMAP 03 CS2	21 x 2	MMAP 03CS232	32 x 2				
with pegs and aluminium cover, high construction ¹⁾	CMAP 03 CS29	29	MMAP 03 CS40	40				
with pegs and aluminium cover, high construction ¹⁾	CMAP 03CS229	29 x 2	MMAP 03CS240	40 x 2				
with pegs and plastic cover ¹⁾	CMP 03 CP	16	MMP 03 CP20	20				
with pegs and plastic cover ¹⁾	CMP 03 CP2	16 x 2	MMP 03 CP220	20 x 2				
with pegs and plastic cover, high construction ¹⁾	CMAP 03 CP	21	MMAP 03 CP32	32				
with pegs and plastic cover, high construction ¹⁾	CMAP 03 CP2	21 x 2	MMAP 03CP232	32 x 2				
with pegs and plastic cover, high construction ¹⁾	CMAP 03 CP29	29	MMAP 03 CP40	40				
with pegs and plastic cover, high construction ¹⁾	CMAP 03CP229	29 x 2	MMAP 03CP240	40 x 2				
with lever and cover					CMP 03 LS	16	MMP 03 LS20	20
with lever and cover					CMP 03 LS2	16 x 2	MMP 03 LS220	20 x 2
with lever and cover, high construction					CMAP 03 LS	21	MMAP 03 LS32	32
with lever and cover, high construction					CMAP 03 LS2	21 x 2	MMAP 03LS232	32 x 2
with lever and cover, high construction					CMAP 03 LS29	29	MMAP 03 LS40	40
with lever and cover, high construction					CMAP 03LS229	29 x 2	MMAP 03LS240	40 x 2

¹⁾ May be combined with hoods:
 - CMO/CMAO 03 X and CMV/CMAV 03 X
 - MMO/MMAO 03 X and MMV/MMAV 03 X

N.B.: the enclosures ensure IP66 protection (or IP65 cover versions) rating when mated and locked with the closing levers.
 The cover (CS, CP) only ensures mechanical protection, but does not ensure IP65 protection rating.

dimensions in mm

CMP - CMAP and MMP - MMAP

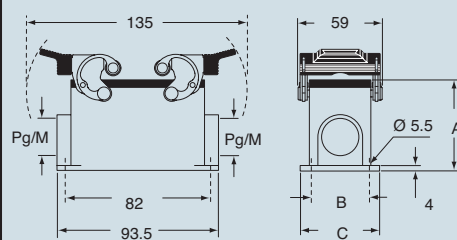

CMP CS/CP - CMAP CS/CP and MMP CS/CP - MMAP CS/CP

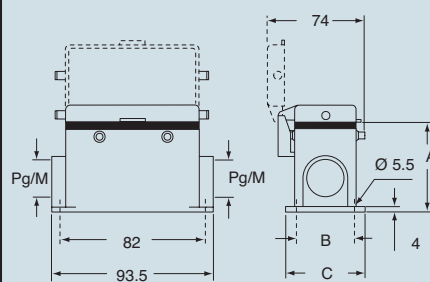

type	A	B	C
CMP / MMP	57	40	52
CMAP / MMAP	74	45	57
CMP CS / MMP CS	57	40	52
CMAP CS / MMAP CS	74	45	57
CMP CP / MMP CP	57	40	52
CMAP CP / MMAP CP	74	45	57

dimensions in mm

CMP L - CMAP L and MMP L - MMAP L

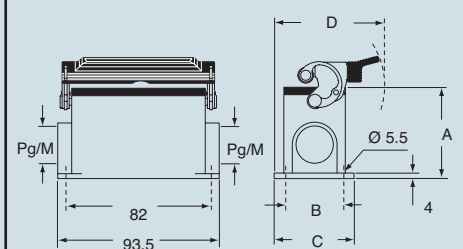

CMP LS - CMAP LS and MMP LS - MMAP LS

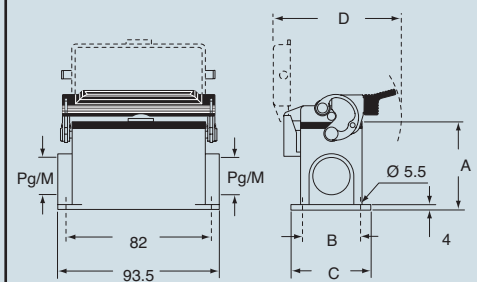

type	A	B	C	D
CMP L / MMP L	57	40	52	79.5
CMAP L / MMAP L	74	45	57	82
CMP LS / MMP LS	57	40	52	97
CMAP LS / MMAP LS	74	45	57	97

CRAUS® Type 4/4X/12

(excluding enclosures with plastic cover)

dimensions indicated are not binding and may be changed without notice



inserts: page
CME3 + 2 (aux) poles + ⊕ 115

insert centre distance:
57 x 27 mm

hoods with 4 pegs



hoods with 2 pegs

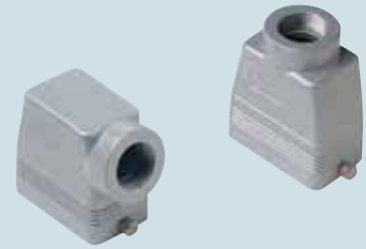

description	part No.		part No.		part No.		part No.	
		entry Pg		entry M		entry Pg		entry M
with pegs, side entry	CMO 03	16	MMO 03.20	20	CMO 03 L	16	MMO 03 L20	20
with pegs, side entry			MMO 03.25	25			MMO 03 L25	25
with pegs, side entry, high construction	CMAO 03.21	21	MMAO 03.32	32	CMAO 03 L21	21	MMAO 03 L32	32
with pegs, side entry, high construction	CMAO 03.29	29	MMAO 03.40	40	CMAO 03 L29	29	MMAO 03 L40	40
with pegs, top entry	CMV 03	16	MMV 03.20	20	CMV 03 L	16	MMV 03 L20 **	20
with pegs, top entry			MMV 03.25	25			MMV 03 L25	25
with pegs, top entry, high construction	CMAV 03.21	21	MMAV 03.32	32	CMAV 03 L21	21	MMAV 03 L32	32
with pegs, top entry, high construction	CMAV 03.29	29	MMAV 03.40	40	CMAV 03 L29	29	MMAV 03 L40	40
with pegs, frontal entry, high construction	CMAF 03	16	MMAF 03.20	20				
with pegs, frontal entry, high constr., without adaptor *	CMFF 03	16	MMFF 03.20	20				

* enclosure without adaptor, threaded on the body, to be used only with a complete cable clamp.

** can only be used with a complete cable clamp (to be purchased separately)

dimensions in mm

CMO (CMAO) and MMO (MMAO)

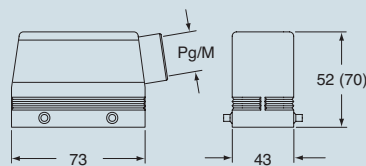

dimensions in mm

CMO L (CMAO L) and MMO L (MMAO L)

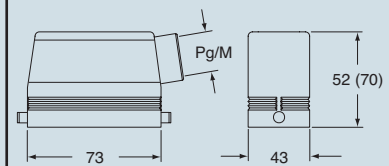

CMV (CMAV) and MMV (MMAV)

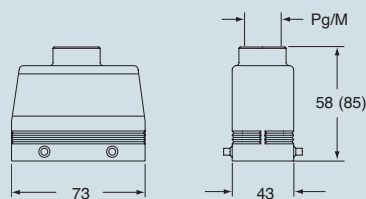

CMV L (CMAV L) and MMV L (MMAV L)

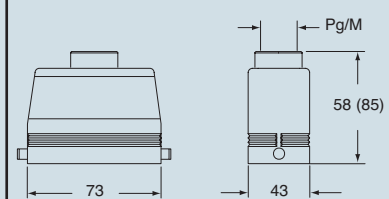

CMAF/CMFF and MMAF/MMFF

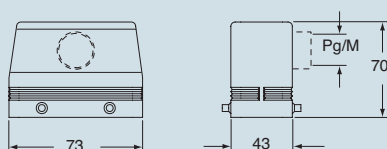

CALUS® Type 4/4X/12

dimensions indicated are not binding and may be changed without notice

size 57.27



inserts: page
CME3 + 2 (aux) poles + ⊕ 115

insert centre distance:
57 x 27 mm

hoods with 2 levers



hoods with single lever



description	part No.		entry Pg		part No.		entry M	
with levers and gasket, top entry	CMV 03 G	16	MMV 03 G25	25	CMV 03 LG	16	MMV 03 LG25	25
with levers and gasket, top entry, high construction	CMAV 03 G	21	MMAV 03 G25	25	CMAV 03 LG21	21	MMAV 03 LG25	25
with levers and gasket, top entry, high construction	CMAV 03 G29	29	MMAV 03 G32	32	CMAV 03 LG29	29	MMAV 03 LG32	32
with levers and gasket, top entry, high constr., without adaptor *	CMFV 03 G	21	MMFV 03 G25	25	CMFV 03 LG21	21	MMFV 03 LG25	25
with levers and gasket, top entry, high constr., without adaptor *	CMFV 03 G29	29	MMFV 03 G32	32	CMFV 03 LG29	29	MMFV 03 LG32	32

* enclosure without adaptor, threaded on the body, to be used only with a complete cable clamp.

dimensions in mm

**CMV G (CMAV G) and [CMFV G],
 MMV G (MMAV G) and [MMFV G]**

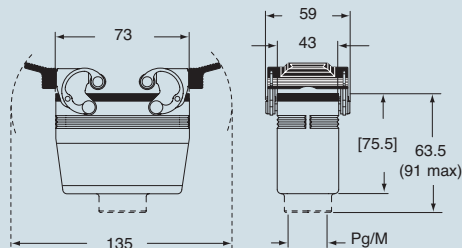

dimensions in mm

**CMV LG (CMAV LG) and [CMFV LG],
 MMV LG (MMAV LG) and [MMFV LG]**

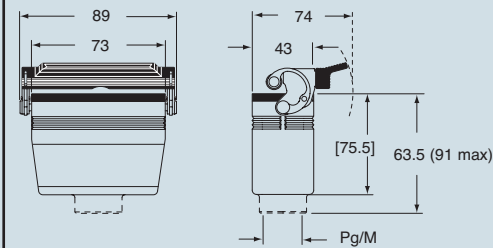

size 57.27



dimensions indicated are not binding and may be changed without notice

inserts: page
CME3 + 2 (aux) poles + ⊕ 115

insert centre distance:
57 x 27 mm

Covers G and LG version are not suitable to be used with code pins. If this application is required please contact ILME SpA.

hoods with 2 levers



covers

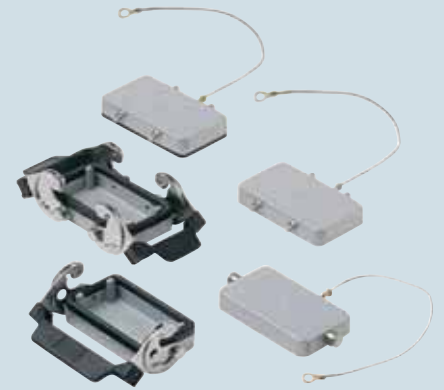

description	part No.		part No.		part No.
		entry Pg		entry M	
with levers, side entry ¹⁾	CMO 03 X	16	MMO 03 X20	20	
with levers, side entry ¹⁾			MMO 03 X25	25	
with levers, side entry, high construction ¹⁾	CMAO 03 X	21	MMAO 03 X32	32	
with levers, side entry, high construction ¹⁾	CMAO 03 X29	29	MMAO 03 X40	40	
with levers, top entry ¹⁾	CMV 03 X	16	MMV 03 X20	20	
with levers, top entry ¹⁾			MMV 03 X25	25	
with levers, top entry, high construction ¹⁾	CMAV 03 X	21	MMAV 03 X32	32	
with levers, top entry, high construction ¹⁾	CMAV 03 X29	29	MMAV 03 X40	40	
with 4 pegs (for housings with 2 levers with gasket)					CHC 10
with 4 pegs and gasket (for housings with 2 levers) ²⁾					CHC 10 C
with 2 pegs (for housings with 1 lever with gasket)					CHC 10 L
with 2 levers (for hoods with 4 pegs)					CHC 10 G
with 1 lever (for hoods with 2 pegs)					CHC 10 LG

¹⁾ May be combined with housings:
 - CMI/CMP/CMAV 03 CS/CP
 - MMP/MMAV 03 CS/CP

²⁾ May be combined with housings:
 - CMO/CMAO 03 X and CMV/CMAV 03 X
 - MMO/MMAO 03 X and MMV/MMAV 03 X

dimensions in mm

CMO X (CMAO X) and MMO X (MMAO X)

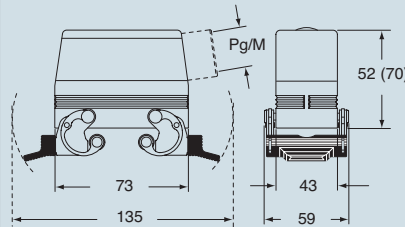

CMV X (CMAV X) and MMV X (MMAV X)

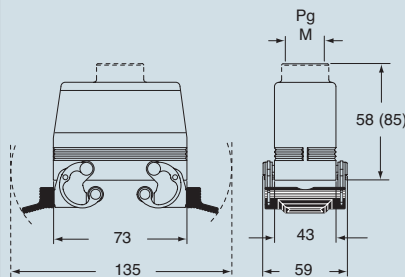

dimensions in mm

CHC



CHC C



CHC L



CHC G

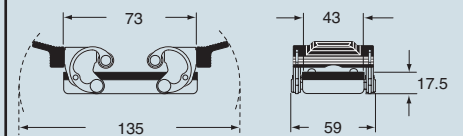

CHC LG

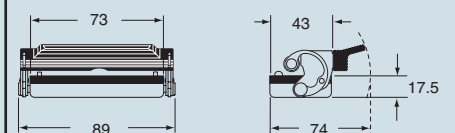

CALUS® Type 4/4X/12

dimensions indicated are not binding and may be changed without notice

inserts: page
CN RY 10 poles + ⊕ 81
CNE RY 10 poles + ⊕ 89

insert centre distance:
57 x 27 mm

The covers for G versions cannot be used together with coding pins. If this application is required, please contact ILME SpA.

housings and cover

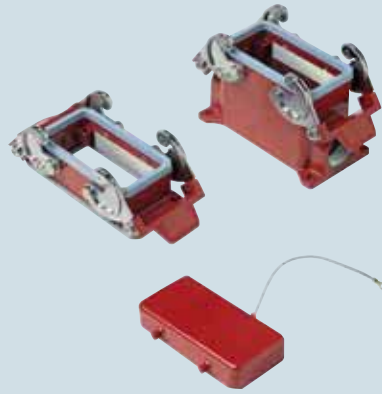

hoods and cover



description	part No.		part No.		part No.		part No.	
	entry Pg	entry M	entry Pg	entry M	entry Pg	entry M	entry Pg	entry M
bulkhead mounting, with levers	CHIR 10	---						
surface mounting, with levers	CHPR 10	16	MHPR 10.20	20				
surface mounting, with levers, high construction	CAPR 10.21	21	MAPR 10.32	32				
cover with 4 pegs (for housings)	CHCR 10							
with pegs, side entry					CHOR 10	16	MHOR 10.20	20
with pegs, side entry, high construction					CAOR 10.21	21	MAOR 10.32	32
with pegs, top entry					CHVR 10	16	MHVR 10.20	20
with pegs, top entry, high construction					CAVR 10.21	21	MAVR 10.32	32
cover with 2 levers (for hoods)					CHCR 10 G			

** can only be used with a complete cable clamp (to be purchased separately)

dimensions in mm

CHIR

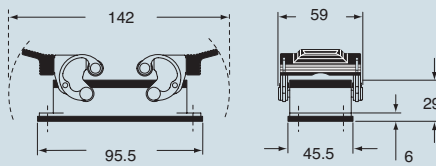

CHPR (CAPR) and MHPR (MAPR)

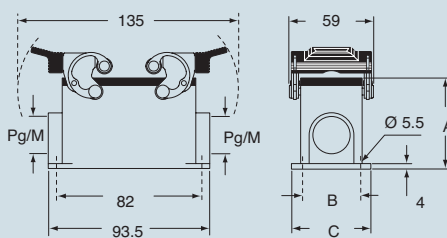

type	A	B	C
CHPR / MHPR	57	40	52
CAPR / MAPR	74	45	57

CHCR



dimensions in mm

CHOR (CAOR) and MHOR (MAOR)

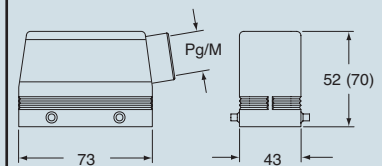

CHVR (CAVR) and MHVR (MAVR)

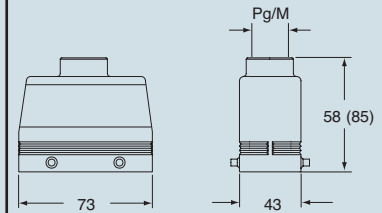

CHCR G

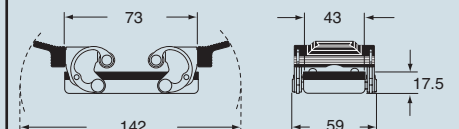

panel cut-out for bulkhead mounting housings in mm

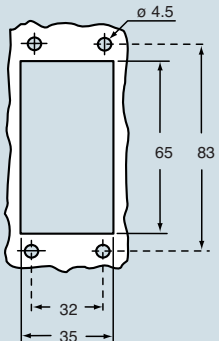

CALUS® Type 4/4X/12

dimensions indicated are not binding and may be changed without notice

size 57.27

inserts:		page
CDD	42 poles + ⊕	55
CQE	18 poles + ⊕	75
CN	10 poles + ⊕	81
CCE	10 poles + ⊕	88
CNE, CSE.....	10 poles + ⊕	89
CSS	10 poles + ⊕	100
CTE, CTSE *).....	10 poles + ⊕	107
CMSE	3+2 (aux) poles + ⊕	114
CMCE	3+2 (aux) poles + ⊕	114
CME	3+2 (aux) poles + ⊕	115
CX	8/24 poles + ⊕	129
MIXO	3 modules	137÷151

insert centre distance: 57 x 27 mm

*) only for enclosure CHIW 10

housings and cover



hoods and cover



description	part No.	entry Pg	part No.	entry M	part No.	entry Pg	part No.	entry M
bulkhead mounting, with levers	CHIW 10	---						
surface mounting, with levers, high construction	CAPW 10.21	21	MAPW 10.32	32				
cover with 4 pegs (for enclosures with 2 levers)	CHCW 10							
with pegs, side entry, high construction					CAOW 10.21	21	MAOW 10.32	32
with pegs, top entry, high construction					CAVW 10.21	21	MAVW 10.32	32
cover with 2 levers (for enclosures with 4 pegs)					CHCW 10 G			
with levers and gasket, top entry, high construction					CAVW 10 G	21	MAVW 10 G32	32

panel cut-out for bulkhead mounting housings in mm

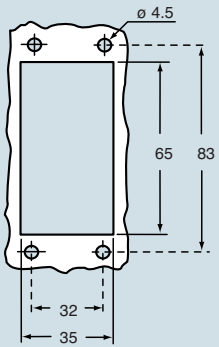

The covers for G versions cannot be used together with coding pins. If this application is required, please contact ILME SpA.

ILME® Type 4/4X/12

dimensions indicated are not binding and may be changed without notice

dimensions in mm

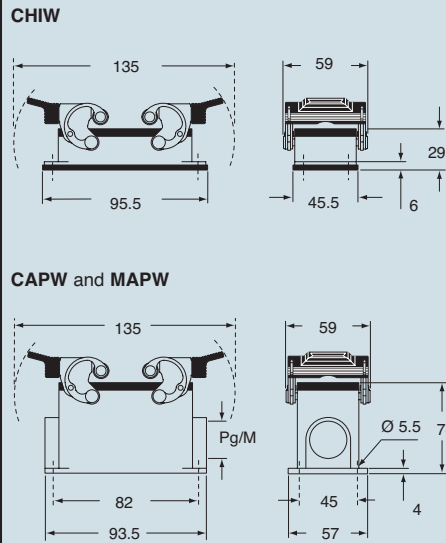

CHCW



dimensions in mm

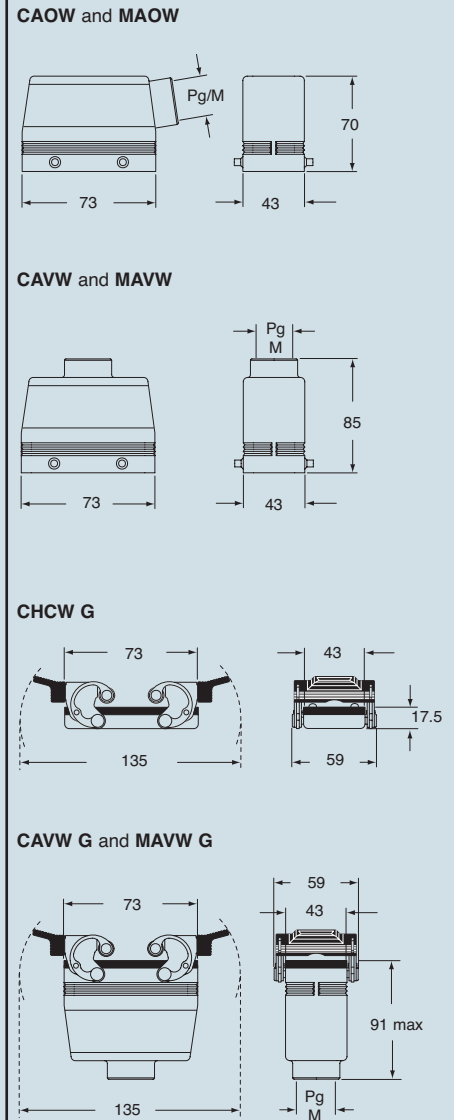

size 57.27

inserts:		page
CDD	42 poles + ⊕	55
CQE	18 poles + ⊕	75
CN	10 poles + ⊕	81
CCE	10 poles + ⊕	88
CNE, CSE.....	10 poles + ⊕	89
CSS	10 poles + ⊕	100
CTE, CTSE *).....	10 poles + ⊕	107
CMSE	3+2 (aux) poles + ⊕	114
CMCE	3+2 (aux) poles + ⊕	114
CX	8/24 poles + ⊕	129
MIXO	3 modules	137÷151

insert centre distance: **57 x 27 mm**

*) only for enclosure CHIS 10

housings and cover for electromagnetic compatibility

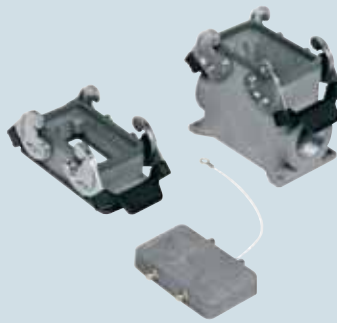

hoods and cover for electromagnetic compatibility



description	part No.	entry Pg	part No.	entry M	part No.	entry Pg	part No.	entry M
bulkhead mounting, with levers	CHIS 10	---						
surface mounting, with levers, high construction	CAPS 10.21	21	MAPS 10.32	32				
cover with 4 pegs (for enclosures with 2 levers)	CHCS 10							
with pegs, side entry, high construction					CAOS 10.21	21	MAOS 10.32	32
with pegs, top entry, high construction					CAVS 10.21	21	MAVS 10.32	32
cover with 2 levers (for enclosures with 4 pegs)					CHCS 10 G			

panel cut-out for bulkhead mounting housings in mm

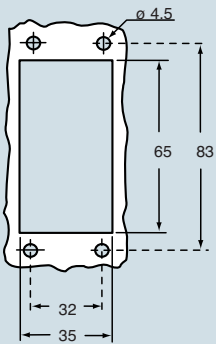

The covers for G versions cannot be used together with coding pins. If this application is required, please contact ILME SpA.

dimensions in mm

CHIS

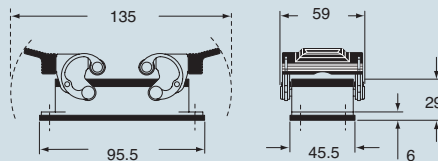

CAPS and MAPS

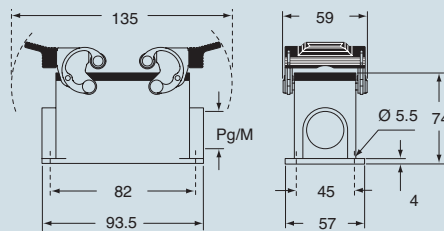

CHCS



dimensions in mm

CAOS and MAOS

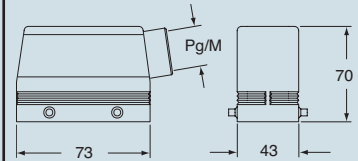

CAVS and MAVS

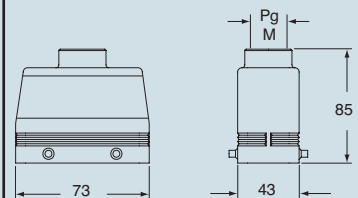

CHCS G

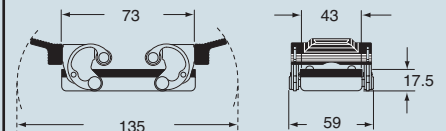

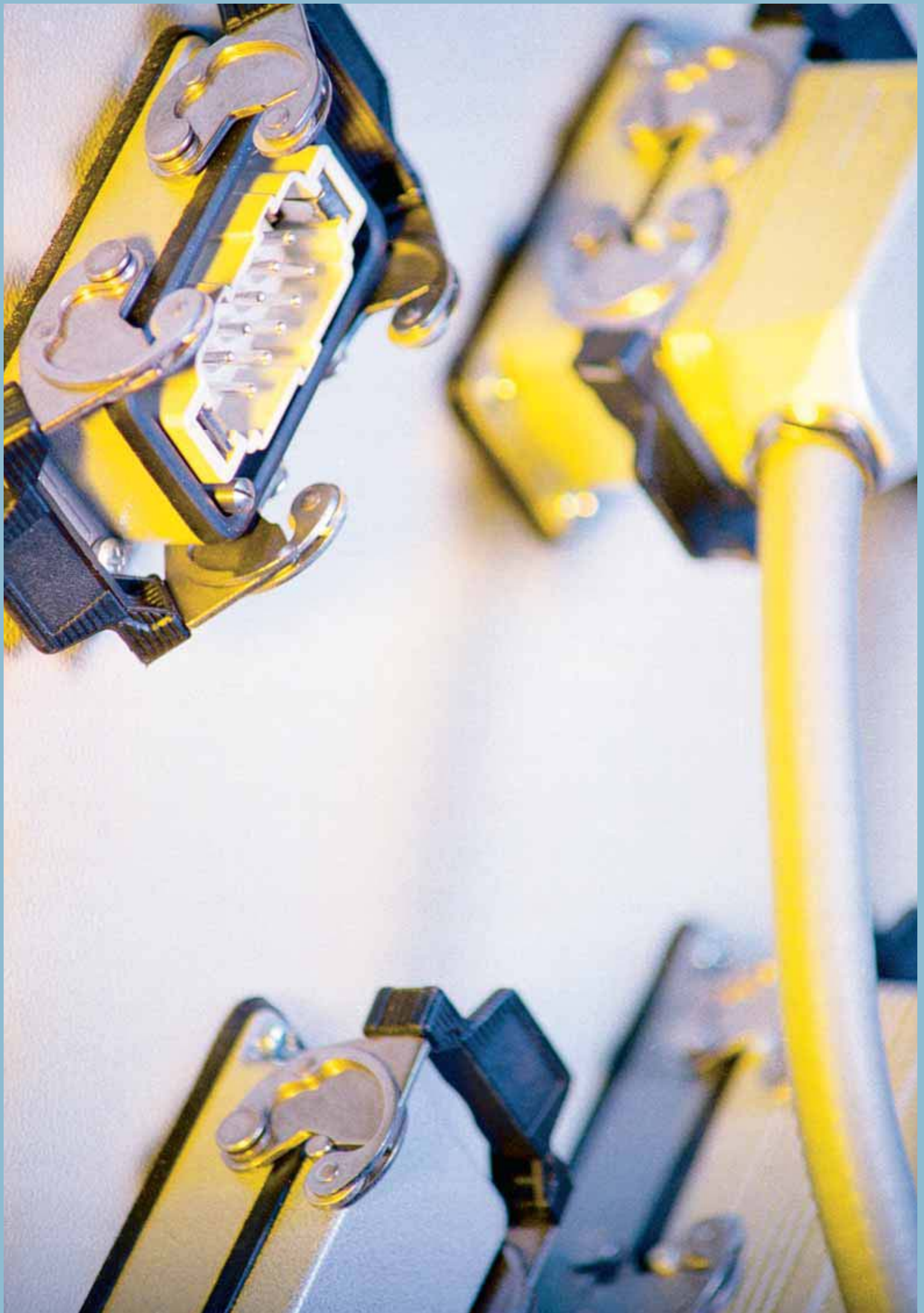

inserts:		page
CD	40 poles + ⊕	43
CT, CTS (10A)	40 poles + ⊕	50
CDD	72 poles + ⊕	56
CQE	32 poles + ⊕	76
CN	16 poles + ⊕	82
CCE	16 poles + ⊕	90
CNE, CSE	16 poles + ⊕	91
CSS	16 poles + ⊕	100
CTE, CTSE (16A)	16 poles + ⊕	108
CMSE	6+2 (aux) poles + ⊕	116
CMCE	6+2 (aux) poles + ⊕	116
CP	6 poles + ⊕	127
CX	6/36 and 12/2 poles + ⊕	130÷131
CX	4/0 and 4/2 poles + ⊕	132
MIXO	4 modules	137÷151

insert centre distance: 77.5 x 27 mm

bulkhead mounting housings with 2 levers or 4 pegs



bulkhead mounting housings with single lever



description	part No.	part No.
with one or two levers	CHI 16	CHI 16 L
with pegs ¹⁾	CHI 16 C	
with pegs and aluminium cover ¹⁾	CHI 16 CS	
with pegs and plastic cover ¹⁾	CHI 16 CP	
with lever and cover		CHI 16 LS

¹⁾ May be combined with hoods:
 - CHO/CAO 16 X and CHV/CAV 16 X
 - MHO/MAO 16 X and MHV/MAV 16 X

N.B.: the enclosures ensure IP66 protection (or IP65 cover versions) rating when mated and locked with the closing levers.
 The cover (CS, CP) only ensures mechanical protection, but does not ensure IP65 protection rating.

panel cut-out for bulkhead mounting housings in mm

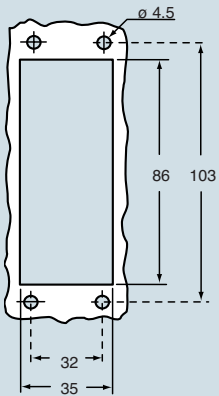

dimensions in mm

CHI

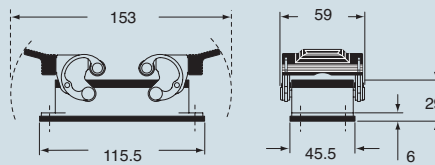

CHI C

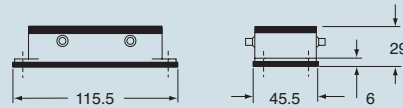

CHI CS/CP

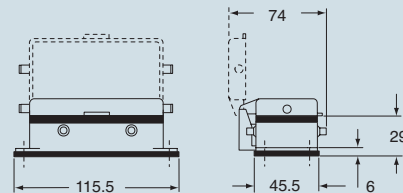

dimensions in mm

CHI L

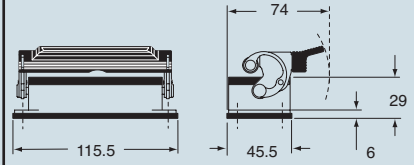

CHI LS

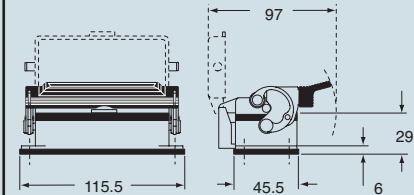

CALUS® Type 4/4X/12
 (excluding enclosures with plastic cover)

dimensions indicated are not binding and may be changed without notice

size 77.27



inserts:	page
CD 40 poles + ⊕	43
CDD 72 poles + ⊕	56
CQE 32 poles + ⊕	76
CN 16 poles + ⊕	82
CCE 16 poles + ⊕	90
CNE, CSE..... 16 poles + ⊕	91
CSS 16 poles + ⊕	100
CMSE 6+2 (aux) poles + ⊕	116
CMCE 6+2 (aux) poles + ⊕	116
CP 6 poles + ⊕	127
CX 6/36 and 12/2 poles + ⊕	130÷131
CX 4/0 and 4/2 poles + ⊕	132
MIXO 4 modules	137÷151

insert centre distance: 77.5 x 27 mm

surface mounting housings with 2 levers or 4 pegs



surface mounting housings with single lever



description	part No.	entry Pg	part No.	entry M	part No.	entry Pg	part No.	entry M
with levers	CHP 16	21	MHP 16.25	25	CHP 16 L	21	MHP 16 L25	25
with levers	CHP 16.2	21 x 2	MHP 16.225	25 x 2	CHP 16 L2	21 x 2	MHP 16 L225	25 x 2
with levers, high construction	CAP 16.21	21	MAP 16.32	32	CAP 16 L	21	MAP 16 L32	32
with levers, high construction	CAP 16.221	21 x 2	MAP 16.232	32 x 2	CAP 16 L2	21 x 2	MAP 16 L232	32 x 2
with levers, high construction	CAP 16.29	29	MAP 16.40	40	CAP 16 L29	29	MAP 16 L40	40
with levers, high construction	CAP 16.229	29 x 2	MAP 16.240	40 x 2	CAP 16 L229	29 x 2	MAP 16 L240	40 x 2
with pegs and aluminium cover ¹⁾	CHP 16 CS	21	MHP 16 CS25	25				
with pegs and aluminium cover ¹⁾	CHP 16 CS2	21 x 2	MHP 16 CS225	25 x 2				
with pegs and aluminium cover, high construction ¹⁾	CAP 16 CS	21	MAP 16 CS32	32				
with pegs and aluminium cover, high construction ¹⁾	CAP 16 CS2	21 x 2	MAP 16 CS232	32 x 2				
with pegs and aluminium cover, high construction ¹⁾	CAP 16 CS29	29	MAP 16 CS40	40				
with pegs and aluminium cover, high construction ¹⁾	CAP 16 CS229	29 x 2	MAP 16 CS240	40 x 2				
with pegs and plastic cover ¹⁾	CHP 16 CP	21	MHP 16 CP25	25				
with pegs and plastic cover ¹⁾	CHP 16 CP2	21 x 2	MHP 16 CP225	25 x 2				
with pegs and plastic cover, high construction ¹⁾	CAP 16 CP	21	MAP 16 CP32	32				
with pegs and plastic cover, high construction ¹⁾	CAP 16 CP2	21 x 2	MAP 16 CP232	32 x 2				
with pegs and plastic cover, high construction ¹⁾	CAP 16 CP29	29	MAP 16 CP40	40				
with pegs and plastic cover, high construction ¹⁾	CAP 16 CP229	29 x 2	MAP 16 CP240	40 x 2				
with lever and cover					CHP 16 LS	21	MHP 16 LS25	25
with lever and cover					CHP 16 LS2	21 x 2	MHP 16 LS225	25 x 2
with lever and cover, high construction					CAP 16 LS	21	MAP 16 LS32	32
with lever and cover, high construction					CAP 16 LS2	21 x 2	MAP 16 LS232	32 x 2
with lever and cover, high construction					CAP 16 LS29	29	MAP 16 LS40	40
with lever and cover, high construction					CAP 16 LS229	29 x 2	MAP 16 LS240	40 x 2

¹⁾ May be combined with hoods:
 - CHO/CAO 16 X and CHV/CAV 16 X
 - MHO/MAO 16 X and MHV/MAV 16 X

N.B.: the enclosures ensure IP66 protection (or IP65 cover versions) rating when mated and locked with the closing levers.
 The cover (CS, CP) only ensures mechanical protection, but does not ensure IP65 protection rating.

dimensions in mm

CHP - CAP and MHP - MAP

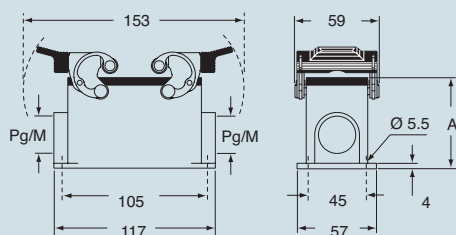

CHP CS/CP - CAP CS/CP and MHP CS/CP - MAP CS/CP

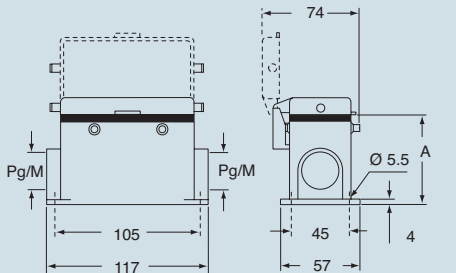

type	A
CHP / MHP	63
CAP / MAP	81
CHP CS / MHP CS	63
CAP CS / MAP CS	81
CHP CP / MHP CP	63
CAP CP / MAP CP	81

dimensions in mm

CHP L - CAP L and MHP L - MAP L

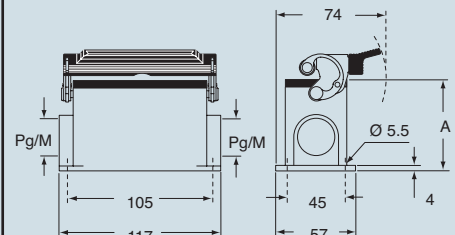

CHP LS - CAP LS and MHP LS - MAP LS

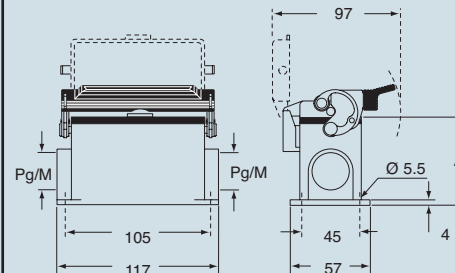

type	A
CHP L / MHP L	63
CAP L / MAP L	81
CHP LS / MHP LS	63
CAP LS / MAP LS	81

CALUS® Type 4/4X/12

(excluding enclosures with plastic cover)

dimensions indicated are not binding and may be changed without notice

size 77.27



inserts:		page
CD	40 poles + ⊕	43
CDD	72 poles + ⊕	56
CQE	32 poles + ⊕	76
CN	16 poles + ⊕	82
CCE	16 poles + ⊕	90
CNE, CSE	16 poles + ⊕	91
CSS	16 poles + ⊕	100
CMSE	6+2 (aux) poles + ⊕	116
CMCE	6+2 (aux) poles + ⊕	116
CP	6 poles + ⊕	127
CX	6/36 and 12/2 poles + ⊕	130÷131
CX	4/0 and 4/2 poles + ⊕	132
MIXO	4 modules	137÷151

insert centre distance: **77.5 x 27 mm**

hoods with 4 pegs



hoods with 2 pegs



description	part No.	entry Pg	part No.	entry M	part No.	entry Pg	part No.	entry M
with pegs, side entry	CHO 16	21	MHO 16.25	25	CHO 16 L	21	MHO 16 L25	25
with pegs, side entry			MHO 16.32	32			MHO 16 L32	32
with pegs, side entry, high construction	CAO 16.21	21	MAO 16.32	32	CAO 16 L21	21	MAO 16 L32	32
with pegs, side entry, high construction	CAO 16.29	29	MAO 16.40	40	CAO 16 L29	29	MAO 16 L40	40
with pegs, top entry	CHV 16	21	MHV 16.25	25	CHV 16 L	21	MHV 16 L25	25
with pegs, top entry			MHV 16.32	32			MHV 16 L32	32
with pegs, top entry, high construction	CAV 16.21	21	MAV 16.32	32	CAV 16 L21	21	MAV 16 L32	32
with pegs, top entry, high construction	CAV 16.29	29	MAV 16.40	40	CAV 16 L29	29	MAV 16 L40	40
with pegs, frontal entry, high construction	CAF 16	21	MAF 16.25	25				
with pegs, frontal entry, high constr., without adaptor *			MFF 16.25	25				

* enclosure without adaptor, threaded on the body, to be used only with a complete cable clamp.

** can only be used with a complete cable clamp (to be purchased separately)

dimensions in mm

CHO (CAO) and MHO (MAO)

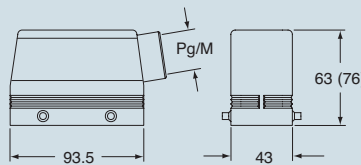

dimensions in mm

CHO L (CAO L) and MHO L (MAO L)

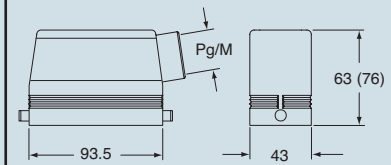

CHV (CAV) and MHV (MAV)

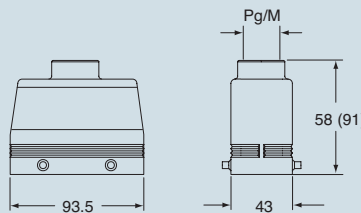

CHV L (CAV L) and MHV L (MAV L)

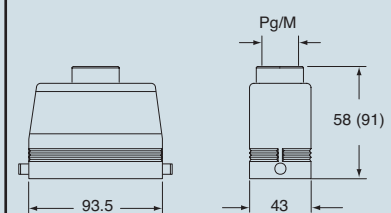

CAF/CFF and MAF/MFF

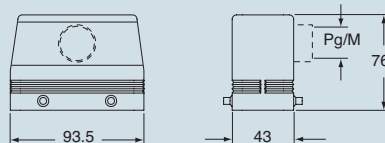

dimensions indicated are not binding and may be changed without notice

size 77.27



inserts:	page
CD 40 poles + ⊕	43
CDD 72 poles + ⊕	56
CQE 32 poles + ⊕	76
CN 16 poles + ⊕	82
CCE 16 poles + ⊕	90
CNE, CSE 16 poles + ⊕	91
CSS 16 poles + ⊕	100
CMSE 6+2 (aux) poles + ⊕	116
CMCE 6+2 (aux) poles + ⊕	116
CP 6 poles + ⊕	127
CX 6/36 and 12/2 poles + ⊕	130÷131
CX 4/0 and 4/2 poles + ⊕	132
MIXO 4 modules	137÷151

insert centre distance: **77.5 x 27 mm**

hoods with 2 levers



hoods with single lever



description	part No.		part No.		part No.		part No.	
	entry Pg	entry M	entry Pg	entry M	entry Pg	entry M	entry Pg	entry M
with levers and gasket, top entry	CHV 16 G	21	MHV 16 G32	32	CHV 16 LG	21	MHV 16 LG32	32
with levers and gasket, top entry, high construction	CAV 16 G	21	MAV 16 G25	25	CAV 16 LG21	21	MAV 16 LG25	25
with levers and gasket, top entry, high construction	CAV 16 G29	29	MAV 16 G32	32	CAV 16 LG29	29	MAV 16 LG32	32
with levers and gasket, top entry, high constr., without adaptor *	CFV 16 G	21	MFV 16 G25	25	CFV 16 LG21	21	MFV 16 LG25	25
with levers and gasket, top entry, high constr., without adaptor *	CFV 16 G29	29	MFV 16 G32	32	CFV 16 LG29	29	MFV 16 LG32	32

* enclosure without adaptor, threaded on the body, to be used only with a complete cable clamp.

dimensions in mm

**CHV G (CAV G) and [CFV G],
MHV G (MAV G) and [MFV G]**

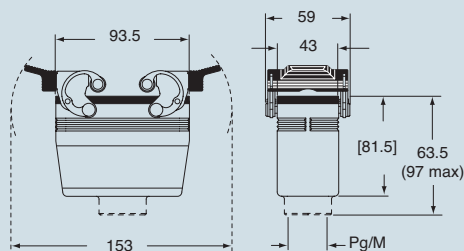

dimensions in mm

**CHV LG (CAV LG) and [CFV LG],
MHV LG (MAV LG) and [MFV LG]**

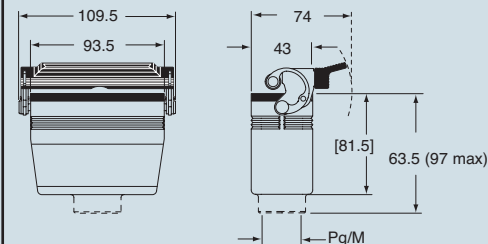

CRUS® Type 4/4X/12

dimensions indicated are not binding and may be changed without notice

size 77.27



inserts:		page
CD	40 poles + ⊕	43
CDD	72 poles + ⊕	56
CQE	32 poles + ⊕	76
CN	16 poles + ⊕	82
CCE	16 poles + ⊕	90
CNE, CSE	16 poles + ⊕	91
CSS	16 poles + ⊕	100
CMSE	6+2 (aux) poles + ⊕	116
CMCE	6+2 (aux) poles + ⊕	116
CP	6 poles + ⊕	127
CX	6/36 and 12/2 poles + ⊕	130÷131
CX	4/0 and 4/2 poles + ⊕	132
MIXO	4 modules	137÷151

insert centre distance:
77.5 x 27 mm

hoods with 2 levers



covers

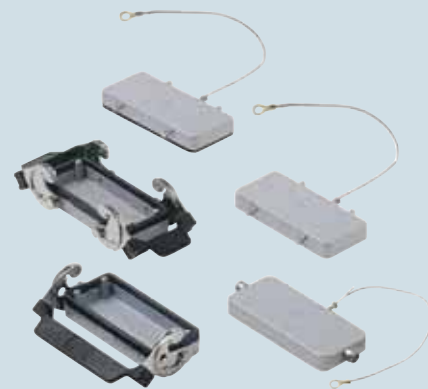

description	part No.		part No.		part No.
		entry Pg		entry M	
with levers, side entry ¹⁾	CHO 16 X	21	MHO 16 X25	25	
with levers, side entry ¹⁾			MHO 16 X32	32	
with levers, side entry, high construction ¹⁾	CAO 16 X	21	MAO 16 X32	32	
with levers, side entry, high construction ¹⁾	CAO 16 X29	29	MAO 16 X40	40	
with levers, top entry ¹⁾	CHV 16 X	21	MHV 16 X25	25	
with levers, top entry ¹⁾			MHV 16 X32	32	
with levers, top entry, high construction ¹⁾	CAV 16 X	21	MAV 16 X32	32	
with levers, top entry, high construction ¹⁾	CAV 16 X29	29	MAV 16 X40	40	
with 4 pegs (for housings with 2 levers with gasket) with 4 pegs and gasket (for housings with 2 levers) ²⁾ with 2 pegs (for housings with 1 lever with gasket)					CHC 16 CHC 16 C CHC 16 L
with 2 levers (for hoods with 4 pegs) with 1 lever (for hoods with 2 pegs)					CHC 16 G CHC 16 LG

¹⁾ May be combined with housings:
- CHI/CHP/CAP 16 CS/CP/C
- MHP/MAP 16 CS/CP

²⁾ May be combined with housings:
- CHO/CAO 16 X and CHV/CAV 16 X
- MHO/MAO 16 X and MHV/MAV 16 X

The covers for C, G and LG, versions cannot be used together with coding pins. If this application is required, please contact ILME SpA.

dimensions in mm

CHO X (CAO X) and MHO X (MAO X)

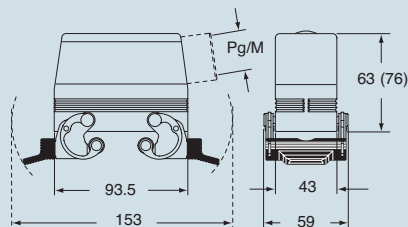

CHV X (CAV X) and MHV X (MAV X)

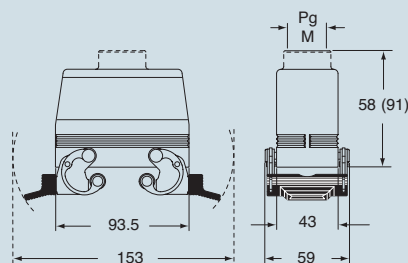

dimensions in mm

CHC

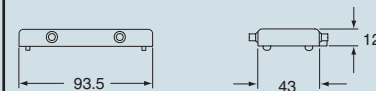

CHC C



CHC L

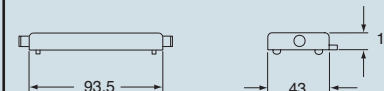

CHC G

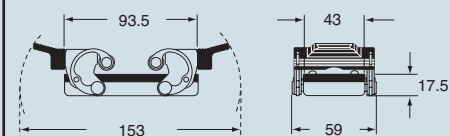

CHC LG

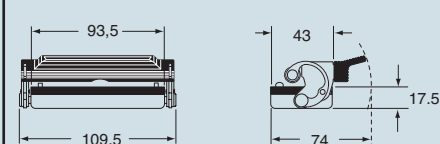

CRUS® Type
4/4X/12

dimensions indicated are not binding and may be changed without notice



inserts: page
CME 6 + 2 (aux) poles + ⊕ 117

insert centre distance:
77.5 x 27 mm

bulkhead mounting housings with 2 levers or 4 pegs



bulkhead mounting housings with single lever



description	part No.	part No.
with one or two levers	CMI 06	CMI 06 L
with pegs and aluminium cover ¹⁾	CMI 06 CS	
with pegs and plastic cover ¹⁾	CMI 06 CP	
with lever and cover		CMI 06 LS

¹⁾ May be combined with hoods:
 - CMO/CMAO 06 X and CMV/CMAV 06 X
 - MMO/MMAO 06 X and MMV/MMAV 06 X

N.B.: the enclosures ensure IP66 protection (or IP65 cover versions) rating when mated and locked with the closing levers.
 The cover (CS, CP) only ensures mechanical protection, but does not ensure IP65 protection rating.

panel cut-out for bulkhead mounting housings in mm

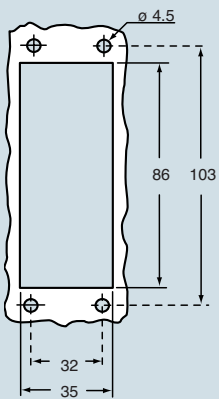

dimensions in mm

CMI

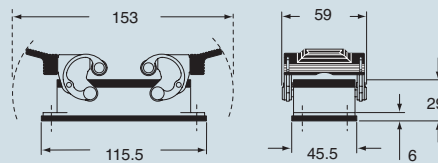

dimensions in mm

CMI L

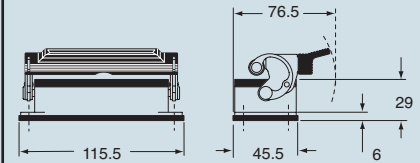

CMI CS/CP

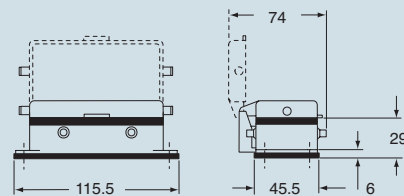

CMI LS

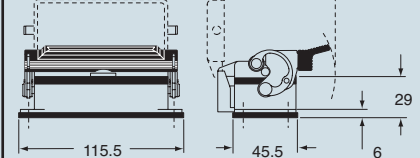

CAUS® Type 4/4X/12
 (excluding enclosures with plastic cover)

dimensions indicated are not binding and may be changed without notice

size 77.27



inserts: page
CME 6 + 2 (aux) poles + ⊕ 117

insert centre distance:
77.5 x 27 mm

surface mounting housings with 2 levers or 4 pegs



surface mounting housings with single lever



description	part No.		entry Pg		part No.		entry M	
with levers	CMP 06	21	MMP 06.25	25	CMP 06 L	21	MMP 06 L25	25
with levers	CMP 06.2	21 x 2	MMP 06.225	25 x 2	CMP 06 L2	21 x 2	MMP 06 L225	25 x 2
with levers, high construction	CMAP 06.21	21	MMAP 06.32	32	CMAP 06 L	21	MMAP 06 L32	32
with levers, high construction	CMAP 06.221	21 x 2	MMAP 06.232	32 x 2	CMAP 06 L2	21 x 2	MMAP 06 L232	32 x 2
with levers, high construction	CMAP 06.29	29	MMAP 06.40	40	CMAP 06 L29	29	MMAP 06 L40	40
with levers, high construction	CMAP 06.229	29 x 2	MMAP 06.240	40 x 2	CMAP 06 L229	29 x 2	MMAP 06 L240	40 x 2
with pegs and aluminium cover ¹⁾	CMP 06 CS	21	MMP 06 CS25	25				
with pegs and aluminium cover ¹⁾	CMP 06 CS2	21 x 2	MMP 06 CS225	25 x 2				
with pegs and aluminium cover, high construction ¹⁾	CMAP 06 CS	21	MMAP 06 CS32	32				
with pegs and aluminium cover, high construction ¹⁾	CMAP 06 CS2	21 x 2	MMAP 06CS232	32 x 2				
with pegs and aluminium cover, high construction ¹⁾	CMAP 06 CS29	29	MMAP 06 CS40	40				
with pegs and aluminium cover, high construction ¹⁾	CMAP 06CS229	29 x 2	MMAP 06CS240	40 x 2				
with pegs and plastic cover ¹⁾	CMP 06 CP	21	MMP 06 CP25	25				
with pegs and plastic cover ¹⁾	CMP 06 CP2	21 x 2	MMP 06 CP225	25 x 2				
with pegs and plastic cover, high construction ¹⁾	CMAP 06 CP	21	MMAP 06 CP32	32				
with pegs and plastic cover, high construction ¹⁾	CMAP 06 CP2	21 x 2	MMAP 06CP232	32 x 2				
with pegs and plastic cover, high construction ¹⁾	CMAP 06 CP29	29	MMAP 06 CP40	40				
with pegs and plastic cover, high construction ¹⁾	CMAP 06CP229	29 x 2	MMAP 06CP240	40 x 2				
with lever and cover					CMP 06 LS	21	MMP 06 LS25	25
with lever and cover					CMP 06 LS2	21 x 2	MMP 06 LS225	25 x 2
with lever and cover, high construction					CMAP 06 LS	21	MMAP 06 LS32	32
with lever and cover, high construction					CMAP 06 LS2	21 x 2	MMAP 06LS232	32 x 2
with lever and cover, high construction					CMAP 06 LS29	29	MMAP 06 LS40	40
with lever and cover, high construction					CMAP 06LS229	29 x 2	MMAP 06LS240	40 x 2

size 77.27

¹⁾ May be combined with hoods:
 - CMO/CMAO 06 X and CMV/CMAV 06 X
 - MMO/MMAO 06 X and MMV/MMAV 06 X

N.B.: the enclosures ensure IP66 protection (or IP65 cover versions) rating when mated and locked with the closing levers.
 The cover (CS, CP) only ensures mechanical protection, but does not ensure IP65 protection rating.

dimensions in mm

CMP - CMAP and MMP - MMAP

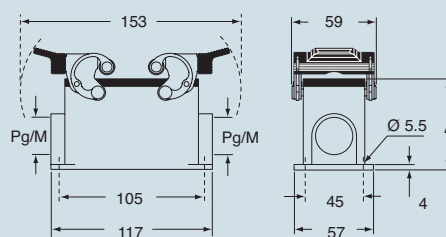

dimensions in mm

CMP L - CMAP L and MMP L - MMAP L

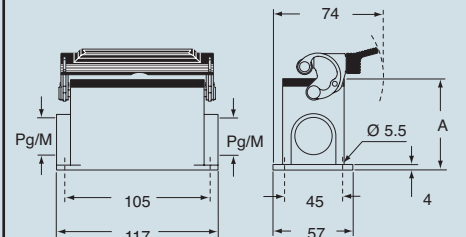

CMP CS/CP - CMAP CS/CP and MMP CS/CP - MMAP CS/CP

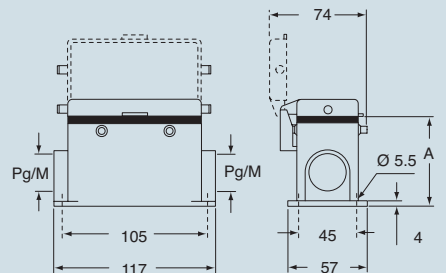

CMP LS - CMAP LS and MMP LS - MMAP LS

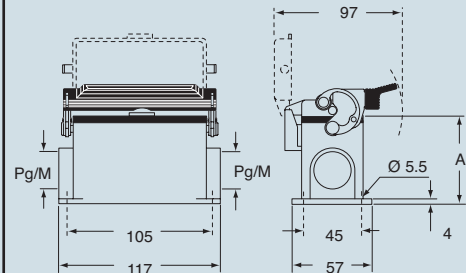

(excluding enclosures with plastic cover)

type	A
CMP / MMP	63
CMAP / MMAP	81
CMP CS / MMP CS	63
CMAP CS / MMAP CS	81
CMP CP / MMP CP	63
CMAP CP / MMAP CP	81

type	A
CMP L / MMP L	63
CMAP L / MMAP L	81
CMP LS / MMP LS	63
CMAP LS / MMAP LS	81

dimensions indicated are not binding and may be changed without notice



inserts: page
CME 6 + 2 (aux) poles + ⊕ 117

insert centre distance:
77.5 x 27 mm

hoods with 4 pegs



hoods with 2 pegs



description	part No.		part No.		part No.		part No.	
		entry Pg		entry M		entry Pg		entry M
with pegs, side entry	CMO 06	21	MMO 06.25	25	CMO 06 L	21	MMO 06 L25	25
with pegs, side entry			MMO 06.32	32			MMO 06 L32	32
with pegs, side entry, high construction	CMAO 06.21	21	MMAO 06.32	32	CMAO 06 L21	21	MMAO 06 L32	32
with pegs, side entry, high construction	CMAO 06.29	29	MMAO 06.40	40	CMAO 06 L29	29	MMAO 06 L40	40
with pegs, top entry	CMV 06	21	MMV 06.25	25	CMV 06 L	21	MMV 06 L25	25
with pegs, top entry			MMV 06.32	32			MMV 06 L32	32
with pegs, top entry, high construction	CMAV 06.21	21	MMAV 06.32	32	CMAV 06 L21	21	MMAV 06 L32	32
with pegs, top entry, high construction	CMAV 06.29	29	MMAV 06.40	40	CMAV 06 L29	29	MMAV 06 L40	40
with pegs, frontal entry, high construction	CMAF 06	21	MMAF 06.25	25				
with pegs, frontal entry, high constr., without adaptor *			MMFF 06.25	25				

* enclosure without adaptor, threaded on the body, to be used only with a complete cable clamp.

** can only be used with a complete cable clamp (to be purchased separately)

dimensions in mm

CMO (CMAO) and MMO (MMAO)

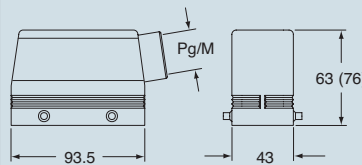

CMV (CMAV) and MMV (MMAV)

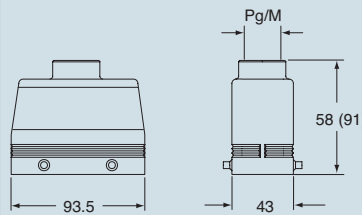

CMAF/CMFF and MMAF/MMFF

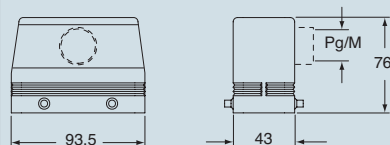

dimensions in mm

CMO L (CMAO L) and MMO L (MMAO L)

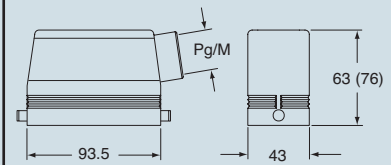

CMV L (CMAV L) and MMV L (MMAV L)

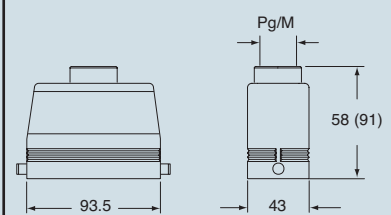

CRUS® Type 4/4X/12

dimensions indicated are not binding and may be changed without notice

size 77.27



inserts: page
CME 6 + 2 (aux) poles + ⊕ 117

insert centre distance:
77.5 x 27 mm

hoods with 2 levers



hoods with single lever



description	part No.		part No.		part No.		part No.	
		entry Pg		entry M		entry Pg		entry M
with levers and gasket, top entry	CMV 06 G	21	MMV 06 G32	32	CMV 06 LG	21	MMV 06 LG32	32
with levers and gasket, top entry, high construction	CMAV 06 G	21	MMAV 06 G25	25	CMAV 06 LG21	21	MMAV 06 LG25	25
with levers and gasket, top entry, high construction	CMAV 06 G29	29	MMAV 06 G32	32	CMAV 06 LG29	29	MMAV 06 LG32	32
with levers and gasket, top entry, high constr., without adaptor *			MMFV 06 G25	25			MMFV 06 LG25	25
with levers and gasket, top entry, high constr., without adaptor *			MMFV 06 G32	32			MMFV 06 LG32	32

* enclosure without adaptor, threaded on the body, to be used only with a complete cable clamp.

dimensions in mm

**CMV G (CMAV G) and [CMFV G],
 MMV G (MMAV G) and [MMFV G]**

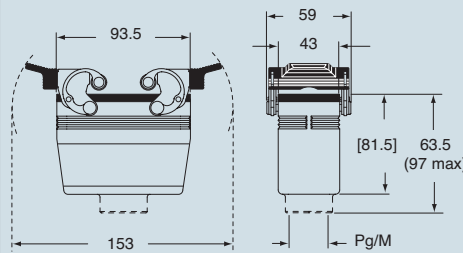

dimensions in mm

**CMV LG (CMAV LG) and [CMFV LG],
 MMV LG (MMAV LG) and [MMFV LG]**

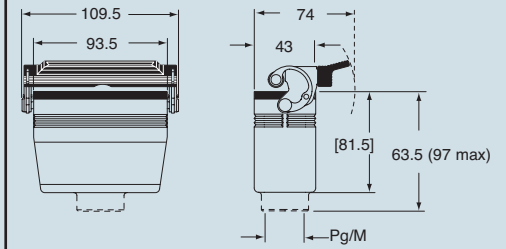

CALUS® Type 4/4X/12

dimensions indicated are not binding and may be changed without notice

size 77.27

inserts: page
CME 6 + 2 (aux) poles + ⊕ 117

insert centre distance:
77.5 x 27 mm

The covers for C, G and LG, versions cannot be used together with coding pins. If this application is required, please contact ILME SpA.

hoods with 2 levers



covers

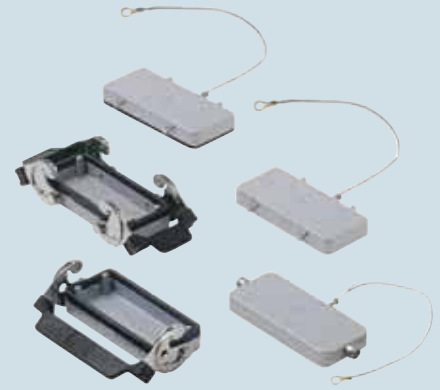

description	part No.		part No.		part No.
		entry Pg		entry M	
with levers, side entry ¹⁾	CMO 06 X	21	MMO 06 X25	25	
with levers, side entry ¹⁾			MMO 06 X32	32	
with levers, side entry, high construction ¹⁾	CMAO 06 X	21	MMAO 06 X32	32	
with levers, side entry, high construction ¹⁾	CMAO 06 X29	29	MMAO 06 X40	40	
with levers, top entry ¹⁾	CMV 06 X	21	MMV 06 X25	25	
with levers, top entry ¹⁾			MMV 06 X32	32	
with levers, top entry, high construction ¹⁾	CMAV 06 X	21	MMAV 06 X32	32	
with levers, top entry, high construction ¹⁾	CMAV 06 X29	29	MMAV 06 X40	40	
with 4 pegs (for enclosures with 2 levers with gasket)					CHC 16
with 4 pegs and gasket (for enclosures with 2 levers) ²⁾					CHC 16 C
with 2 pegs (for enclosures with 1 lever with gasket)					CHC 16 L
with 2 levers (for hoods with 4 pegs)					CHC 16 G
with 1 lever (for hoods with 2 pegs)					CHC 16 LG

¹⁾ May be combined with housings:
 - CMI/CMP/CMAV 06 CS/CP
 - MMP/MMAP 06 CS/CP

²⁾ May be combined with housings:
 - CMO/CMAO 06 X and CMV/CMAV 06 X
 - MMO/MMAO 06 X and MMV/MMAV 06 X

dimensions in mm

CMO X (CMAO X) and MMO X (MMAO X)

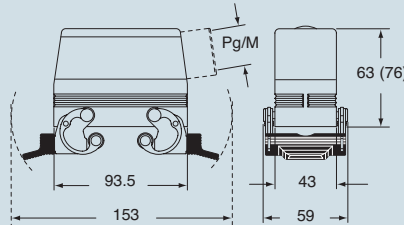

CMV X (CMAV X) and MMV X (MMAV X)

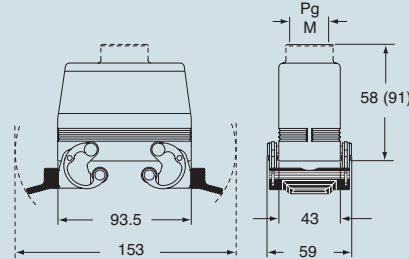

dimensions in mm

CHC



CHC C



CHC L

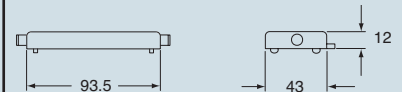

CHC G

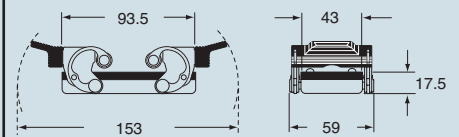

CHC LG

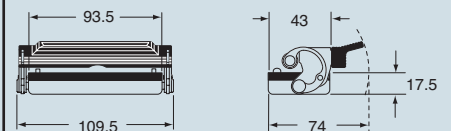

CRAUS® Type 4/4X/12

dimensions indicated are not binding and may be changed without notice

size 77.27



inserts:	page
CN RY 16 poles + ⊕	82
CNE RY 16 poles + ⊕	91
CP RY 6 poles + ⊕	127

insert centre distance:
77.5 x 27 mm

The covers for G versions cannot be used together with coding pins. If this application is required, please contact ILME SpA.

housings and cover

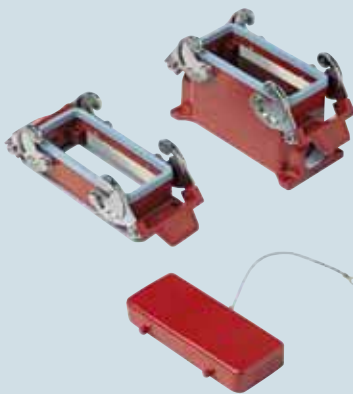

hoods and cover



description	part No.		part No.		part No.		part No.	
	entry Pg	entry M	entry Pg	entry M	entry Pg	entry M	entry Pg	entry M
bulkhead mounting, with levers	CHIR 16	---						
surface mounting, with levers, high construction	CAPR 16.21	21	MAPR 16.32	32				
cover with 4 pegs (for housings)	CHCR 16							
with pegs, side entry					CHOR 16	21	MHOR 16.25	25
with pegs, side entry, high construction					CAOR 16.21	21	MAOR 16.40	40
with pegs, top entry					CHVR 16	21	MHVR 16.25	25
with pegs, top entry, high construction					CAVR 16.21	21	MAVR 16.40	40
cover with 2 levers (for hoods)					CHCR 16 G			

panel cut-out for bulkhead mounting housings in mm

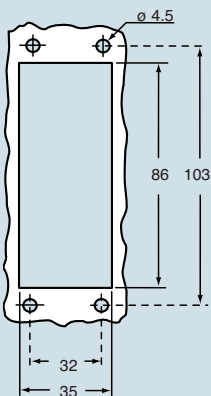

dimensions in mm

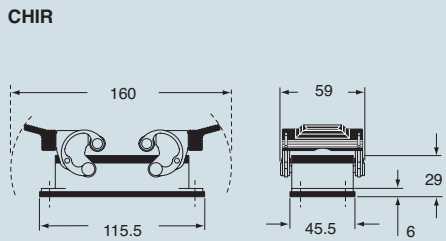

dimensions in mm

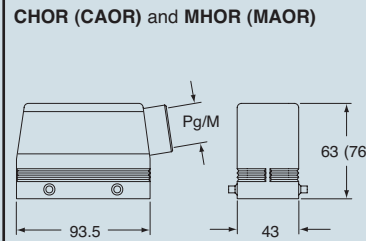

CAPR and MAPR

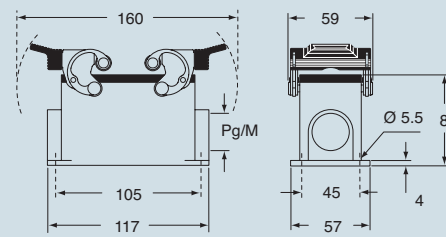

CHVR (CAVR) and MHVR (MAVR)

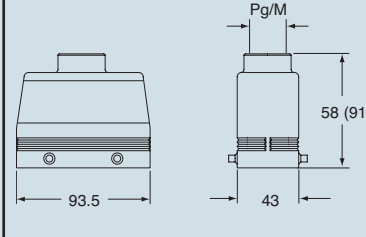

CHCR

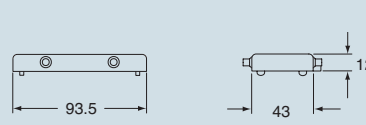

CHCR G

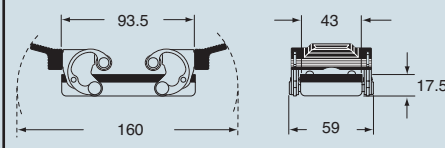

CAUS® Type 4/4X/12

dimensions indicated are not binding and may be changed without notice



inserts:		page
CD	40 poles + ⊕	43
CT, CTS *) (10A)	40 poles + ⊕	50
CDD	72 poles + ⊕	56
CQE	32 poles + ⊕	76
CN	16 poles + ⊕	82
CCE	16 poles + ⊕	90
CNE, CSE	16 poles + ⊕	91
CSS	16 poles + ⊕	100
CTE, CTSE *) (16A)	16 poles + ⊕	108
CMSE	6+2 (aux) poles + ⊕	116
CMCE	6+2 (aux) poles + ⊕	116
CME	6+2 (aux) poles + ⊕	117
CP	6 poles + ⊕	127
CX	6/36 and 12/2 poles + ⊕	130÷131
CX	4/0 and 4/2 poles + ⊕	132
MIXO	4 modules	137÷151

insert centre distance: 77.5 x 27 mm

*) only for enclosure CHIW 16

housings and cover



hoods and cover



description	part No.	entry Pg	part No.	entry M	part No.	entry Pg	part No.	entry M
bulkhead mounting, with levers	CHIW 16	---						
surface mounting, with levers, high construction	CAPW 16.21	21	MAPW 16.32	32				
cover with 4 pegs (for enclosures with 2 levers)	CHCW 16							
with pegs, side entry					CHOW 16	21	MHOW 16.25	25
with pegs, side entry, high construction					CAOW 16.29	29	MHOW 16.32	32
with pegs, side entry, high construction							MAOW 16.32	32
with pegs, top entry					CHVW 16	21	MHVW 16.25	25
with pegs, top entry, high construction					CAVW 16.29	29	MHVW 16.32	32
with pegs, top entry, high construction							MAVW 16.32	32
with pegs, top entry, high construction							MAVW 16.40	40
cover with 2 levers (for enclosures with 4 pegs)					CHCW 16 G			
with levers and gasket, top entry					CAVW 16 G29	29	MAVW 16 G32	32

panel cut-out for bulkhead mounting housings in mm

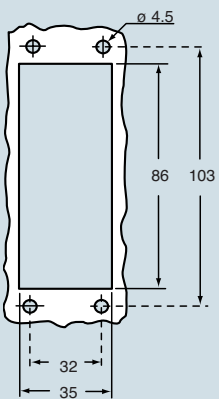

The covers for G versions cannot be used together with coding pins. If this application is required, please contact ILME SpA.

dimensions in mm

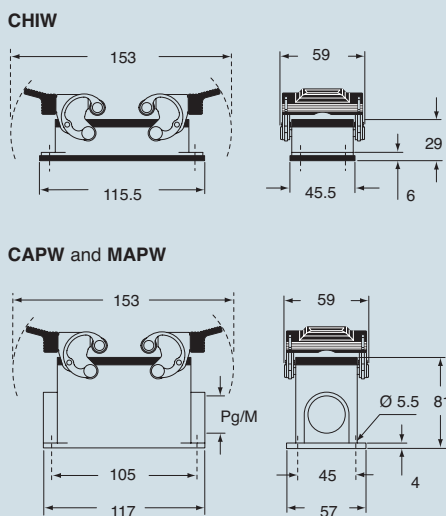

CHCW



dimensions in mm

CHOW (CAOW) and MHOW (MAOW)

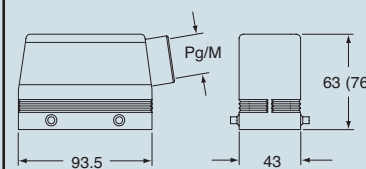

CHVW (CAVW) and MHVW (MAVW)

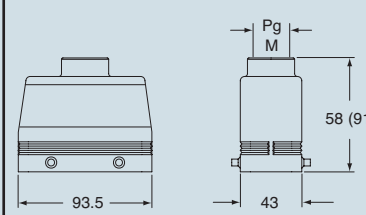

CHCW G

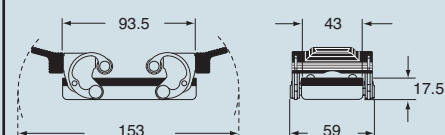

CAVW G and MAVW G

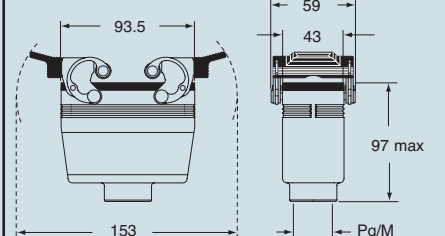

dimensions indicated are not binding and may be changed without notice

size 77.27



inserts:		page
CD	40 poles + ⊕	43
CT, CTS *) (10A)	40 poles + ⊕	50
CDD	72 poles + ⊕	56
CQE	32 poles + ⊕	76
CN	16 poles + ⊕	82
CCE	16 poles + ⊕	90
CNE, CSE.....	16 poles + ⊕	91
CSS	16 poles + ⊕	100
CTE, CTSE *) (16A) 16	poles + ⊕	108
CMSE	6+2 (aux) poles + ⊕	116
CMCE	6+2 (aux) poles + ⊕	116
CP.....	6 poles + ⊕	127
CX	6/36 and 12/2 poles + ⊕	130÷131
CX	4/0 and 4/2 poles + ⊕	132
MIXO	4 modules	137÷151

insert centre distance: 77.5 x 27 mm

*) only for enclosure CHIS 16

housings and cover for electromagnetic compatibility

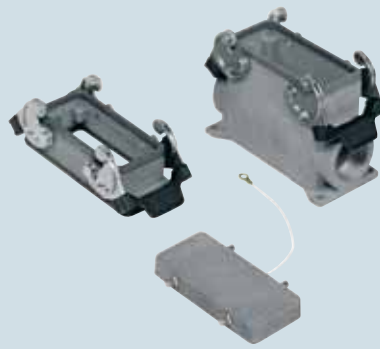

hoods and cover for electromagnetic compatibility



description	part No.		part No.		part No.		part No.	
	entry Pg	entry M	entry Pg	entry M	entry Pg	entry M	entry Pg	entry M
bulkhead mounting, with levers	CHIS 16	---						
surface mounting, with levers, high construction	CAPS 16.21	21	MAPS 16.32	32				
cover with 4 pegs (for enclosures with 2 levers)	CHCS 16							
with pegs, side entry					CHOS 16	21	MHOS 16.25	25
with pegs, side entry					CAOS 16.29	29	MHOS 16.32	32
with pegs, side entry, high construction							MAOS 16.32	32
with pegs, side entry, high construction							MAOS 16.40	40
with pegs, top entry					CHVS 16	21	MHVS 16.25	25
with pegs, top entry							MHVS 16.32	32
with pegs, top entry, high construction					CAVS 16.29	29	MAVS 16.32	32
with pegs, top entry, high construction							MAVS 16.40	40
cover with 2 levers (for enclosures with 4 pegs)					CHCS 16 G			

panel cut-out for bulkhead mounting housings in mm

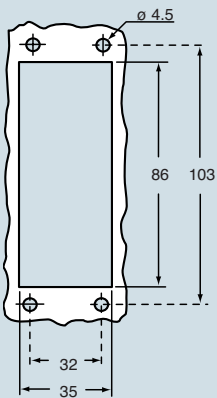

The covers for G versions cannot be used together with coding pins. If this application is required, please contact ILME SpA.

dimensions in mm

CHIS

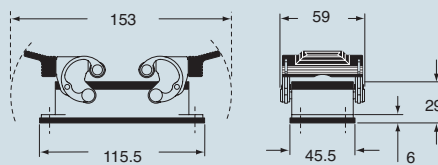

CAPS and MAPS

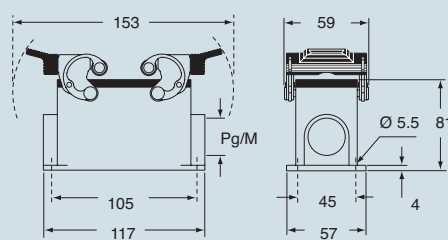

CHCS



dimensions in mm

CHOS (CAOS) and MHOS (MAOS)

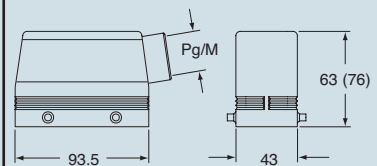

CHVS (CAVS) and MHVS (MAVS)

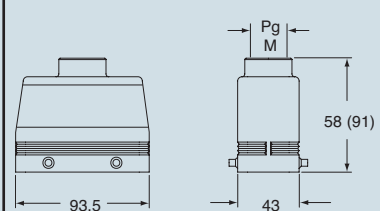

CHCS G

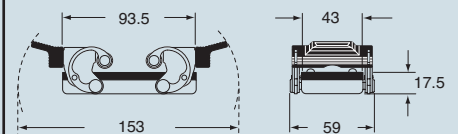

ILME® Type 4/4X/12

dimensions indicated are not binding and may be changed without notice

size 77.27

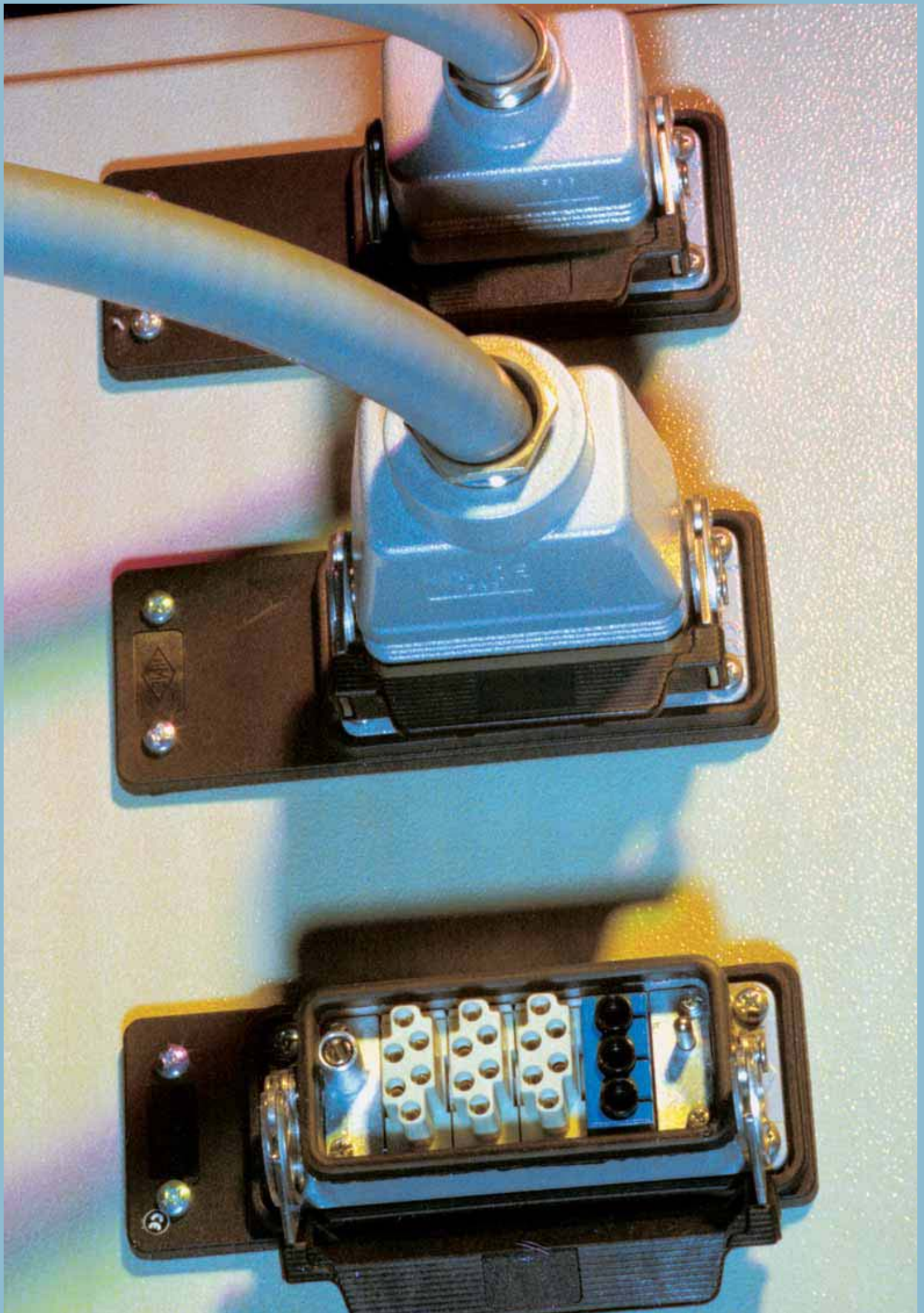



inserts:		page
CD	64 poles + ⊕	45
CT, CTS (10A)	64 poles + ⊕	51
CDD	108 poles + ⊕	58
CQE	46 poles + ⊕	77
CN	24 poles + ⊕	83
CCE	24 poles + ⊕	92
CNE, CSE.....	24 poles + ⊕	93
CSS	24 poles + ⊕	101
CTE, CTSE (16A)....	24 poles + ⊕	109
CMSE	10+2 (aux) poles + ⊕	118
CMCE	10+2 (aux) poles + ⊕	118
CX	4/8 poles + ⊕	133
MIXO	6 modules	137-151

insert centre distance:
104 x 27 mm

bulkhead mounting housings with 2 levers or 4 pegs



bulkhead mounting housings with single lever



description	part No.	part No.
with one or two levers	CHI 24	CHI 24 L
with pegs ¹⁾	CHI 24 C	
with pegs and aluminium cover ¹⁾	CHI 24 CS	
with pegs and plastic cover ¹⁾	CHI 24 CP	
with lever and cover		CHI 24 LS

¹⁾ May be combined with hoods:
- CHO/CAO 24 X and CHV/CAV 24 X
- MHO/MAO 24 X and MHV/MAV 24 X

N.B.: the enclosures ensure IP66 protection (or IP65 cover versions) rating when mated and locked with the closing levers.
The cover (CS, CP) only ensures mechanical protection, but does not ensure IP65 protection rating.

panel cut-out for bulkhead mounting housings in mm

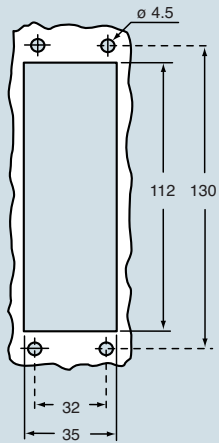

dimensions in mm

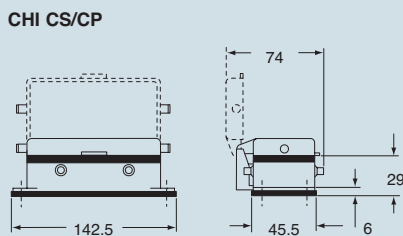
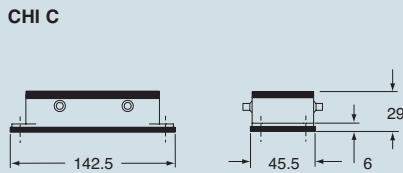
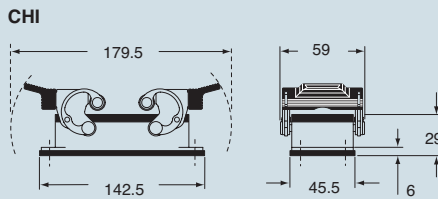

dimensions in mm

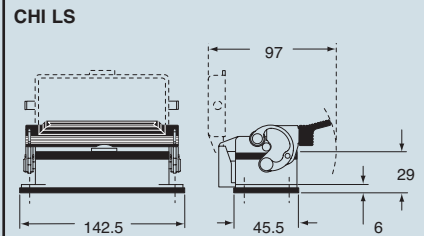
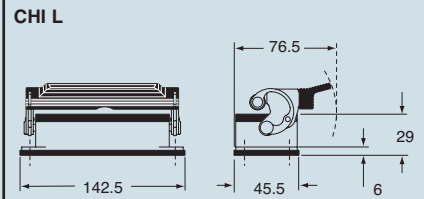

CAUS® Type 4/4X/12
(excluding enclosures with plastic cover)

dimensions indicated are not binding and may be changed without notice

size 77.27



inserts:		page
CD	64 poles + ⊕	45
CDD	108 poles + ⊕	58
CQE	46 poles + ⊕	77
CN	24 poles + ⊕	83
CCE	24 poles + ⊕	92
CNE, CSE.....	24 poles + ⊕	93
CSS	24 poles + ⊕	101
CMSE	10+2 (aux) poles + ⊕	118
CMCE	10+2 (aux) poles + ⊕	118
CX	4/8 poles + ⊕	133
MIXO	6 modules	137+151

insert centre distance:
104 x 27 mm

surface mounting housings with 2 levers or 4 pegs



surface mounting housings with single lever

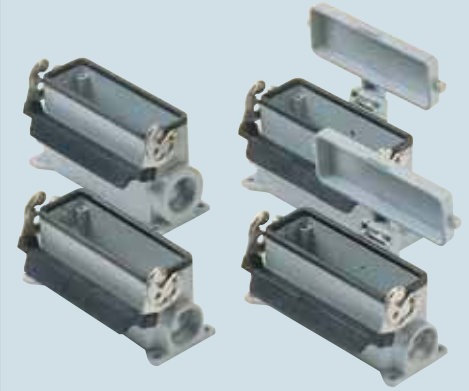

description	part No.		part No.		part No.		part No.	
		entry Pg		entry M		entry Pg		entry M
with levers	CHP 24	21	MHP 24.25	25	CHP 24 L	21	MHP 24 L25	25
with levers	CHP 24.2	21 x 2	MHP 24.225	25 x 2	CHP 24 L2	21 x 2	MHP 24 L225	25 x 2
with levers, high construction	CAP 24.21	21	MAP 24.32	32	CAP 24 L	21	MAP 24 L32	32
with levers, high construction	CAP 24.221	21 x 2	MAP 24.232	32 x 2	CAP 24 L2	21 x 2	MAP 24 L232	32 x 2
with levers, high construction	CAP 24.29	29	MAP 24.40	40	CAP 24 L29	29	MAP 24 L40	40
with levers, high construction	CAP 24.229	29 x 2	MAP 24.240	40 x 2	CAP 24 L229	29 x 2	MAP 24 L240	40 x 2
with pegs and aluminium cover ¹⁾	CHP 24 CS	21	MHP 24 CS25	25				
with pegs and aluminium cover ¹⁾	CHP 24 CS2	21 x 2	MHP 24 CS225	25 x 2				
with pegs and aluminium cover, high construction ¹⁾	CAP 24 CS	21	MAP 24 CS32	32				
with pegs and aluminium cover, high construction ¹⁾	CAP 24 CS2	21 x 2	MAP 24 CS232	32 x 2				
with pegs and aluminium cover, high construction ¹⁾	CAP 24 CS29	29	MAP 24 CS40	40				
with pegs and aluminium cover, high construction ¹⁾	CAP 24 CS229	29 x 2	MAP 24 CS240	40 x 2				
with pegs and plastic cover ¹⁾	CHP 24 CP	21	MHP 24 CP25	25				
with pegs and plastic cover ¹⁾	CHP 24 CP2	21 x 2	MHP 24 CP225	25 x 2				
with pegs and plastic cover, high construction ¹⁾	CAP 24 CP	21	MAP 24 CP32	32				
with pegs and plastic cover, high construction ¹⁾	CAP 24 CP2	21 x 2	MAP 24 CP232	32 x 2				
with pegs and plastic cover, high construction ¹⁾	CAP 24 CP29	29	MAP 24 CP40	40				
with pegs and plastic cover, high construction ¹⁾	CAP 24 CP229	29 x 2	MAP 24 CP240	40 x 2				
with lever and cover					CHP 24 LS	21	MHP 24 LS25	25
with lever and cover					CHP 24 LS2	21 x 2	MHP 24 LS225	25 x 2
with lever and cover, high construction					CAP 24 LS	21	MAP 24 LS32	32
with lever and cover, high construction					CAP 24 LS2	21 x 2	MAP 24 LS232	32 x 2
with lever and cover, high construction					CAP 24 LS29	29	MAP 24 LS40	40
with lever and cover, high construction					CAP 24 LS229	29 x 2	MAP 24 LS240	40 x 2

¹⁾ May be combined with hoods:
- CHO/CAO 24 X and CHV/CAV 24 X
- MHO/MAO 24 X and MHV/MAV 24 X

N.B.: the enclosures ensure IP66 protection (or IP65 cover versions) rating when mated and locked with the closing levers.
The cover (CS, CP) only ensures mechanical protection, but does not ensure IP65 protection rating.

dimensions in mm

CHP - CAP and MHP - MAP

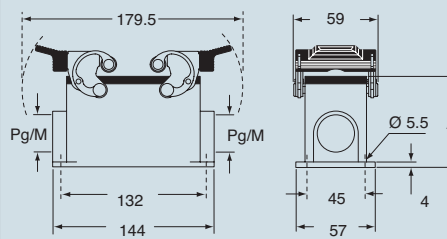

CHP CS/CP - CAP CS/CP and MHP CS/CP - MAP CS/CP

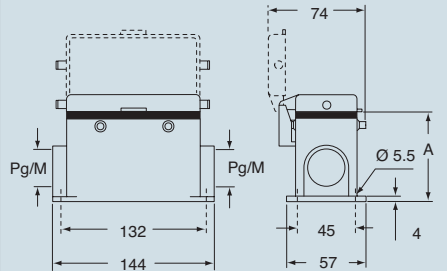

type	A
CHP / MHP	63
CAP / MAP	81
CHP CS / MHP CS	63
CAP CS / MAP CS	81
CHP CP / MHP CP	63
CAP CP / MAP CP	81

dimensions in mm

CHP L - CAP L and MHP L - MAP L

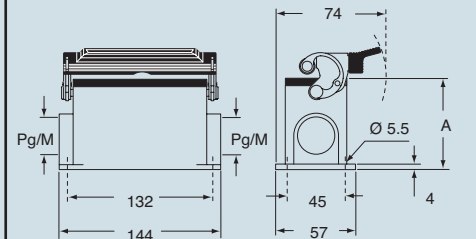

CHP LS - CAP LS and MHP LS - MAP LS

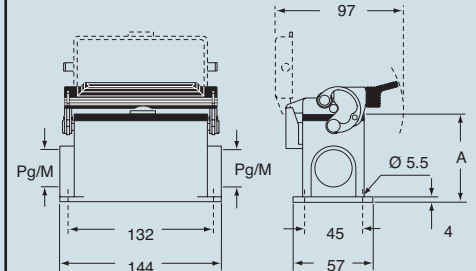

type	A
CHP L / MHP L	63
CAP L / MAP L	81
CHP LS / MHP LS	63
CAP LS / MAP LS	81

CALUS® Type 4/4X/12

(excluding enclosures with plastic cover)

dimensions indicated are not binding and may be changed without notice

size 104.27



inserts:		page
CD	64 poles + ⊕	45
CDD	108 poles + ⊕	58
CQE	46 poles + ⊕	77
CN	24 poles + ⊕	83
CCE	24 poles + ⊕	92
CNE, CSE.....	24 poles + ⊕	93
CSS	24 poles + ⊕	101
CMSE	10+2 (aux) poles + ⊕	118
CMCE	10+2 (aux) poles + ⊕	118
CX	4/8 poles + ⊕	133
MIXO	6 modules	137+151

insert centre distance:
104 x 27 mm

hoods with 4 pegs



hoods with 2 pegs



description	part No.		part No.		part No.		part No.	
		entry Pg		entry M		entry Pg		entry M
with pegs, side entry	CHO 24	21	MHO 24.25	25	CHO 24 L	21	MHO 24 L25	25
with pegs, side entry			MHO 24.32	32			MHO 24 L32	32
with pegs, side entry, high construction	CAO 24.21	21	MAO 24.32	32	CAO 24 L21	21	MAO 24 L32	32
with pegs, side entry, high construction	CAO 24.29	29	MAO 24.40	40	CAO 24 L29	29	MAO 24 L40	40
with pegs, top entry	CHV 24	21	MHV 24.25 **	25	CHV 24 L	21	MHV 24 L25	25
with pegs, top entry			MHV 24.32	32			MHV 24 L32	32
with pegs, top entry	CHV 24.29	29	MHV 24.40	40	CHV 24 L29	29	MHV 24 L40	40
with pegs, top entry, high construction	CAV 24.21	21	MAV 24.32	32	CAV 24 L21	21	MAV 24 L32	32
with pegs, top entry, high construction	CAV 24.29	29	MAV 24.40	40	CAV 24 L29	29	MAV 24 L40	40
with pegs, frontal entry, high construction	CAF 24.21	21	MAF 24.25	25				
with pegs, frontal entry, high construction	CAF 24.29	29	MAF 24.32	32				
with pegs, frontal entry, high construction, without adaptor *	CFF 24.21	21	MFF 24.25	25				
with pegs, frontal entry, high construction, without adaptor *	CFF 24.29	29	MFF 24.32	32				

* enclosure without adaptor, threaded on the body, to be used only with a complete cable clamp.

** can only be used with a complete cable clamp (to be purchased separately)

dimensions in mm

CHO (CAO) and MHO (MAO)

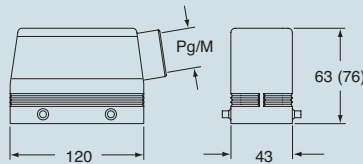

dimensions in mm

CHO L (CAO L) and MHO L (MAO L)

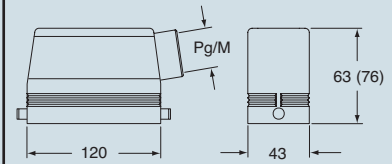

CHV (CAV) and MHV (MAV)

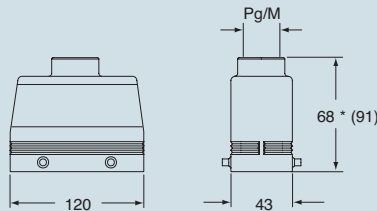

* 69.5 for Pg 29 - M 40 versions

CHV L (CAV L) and MHV L (MAV L)

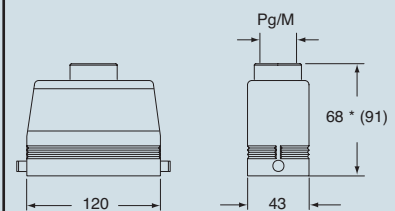

* 69.5 for Pg 29 - M 40 versions

CAF/CFF and MAF/MFF

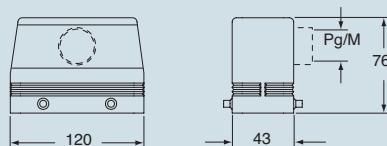

CALUS® Type 4/4X/12

dimensions indicated are not binding and may be changed without notice



inserts:		page
CD	64 poles + ⊕	45
CDD	108 poles + ⊕	58
CQE	46 poles + ⊕	77
CN	24 poles + ⊕	83
CCE	24 poles + ⊕	92
CNE, CSE.....	24 poles + ⊕	93
CSS	24 poles + ⊕	101
CMSE	10+2 (aux) poles + ⊕	118
CMCE	10+2 (aux) poles + ⊕	118
CX	4/8 poles + ⊕	133
MIXO	6 modules	137+151

insert centre distance:
104 x 27 mm

hoods with 2 levers



hoods with single lever



description	part No.		entry Pg		part No.		entry M	
with levers and gasket, top entry	CHV 24 G	21	MHV 24 G32	32	CHV 24 LG	21	MHV 24 LG32	32
with levers and gasket, top entry, high construction	CAV 24 G	21	MAV 24 G25	25	CAV 24 LG21	21	MAV 24 LG25	25
with levers and gasket, top entry, high construction	CAV 24 G29	29	MAV 24 G32	32	CAV 24 LG29	29	MAV 24 LG32	32
with levers and gasket, top entry, high constr., without adaptor *	CFV 24 G	21	MFV 24 G25	25	CFV 24 LG21	21	MFV 24 LG25	25
with levers and gasket, top entry, high constr., without adaptor *	CFV 24 G29	29	MFV 24 G32	32	CFV 24 LG29	29	MFV 24 LG32	32

* enclosure without adaptor, threaded on the body, to be used only with a complete cable clamp.

dimensions in mm

**CHV G (CAV G) and [CFV G],
MHV G (MAV G) and [MFV G]**

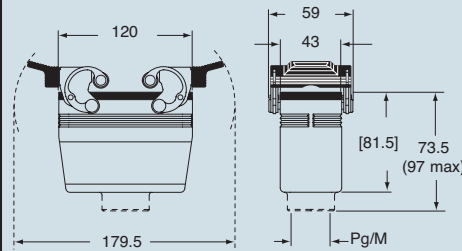

dimensions in mm

**CHV LG (CAV LG) and [CFV LG],
MHV LG (MAV LG) and [MFV LG]**

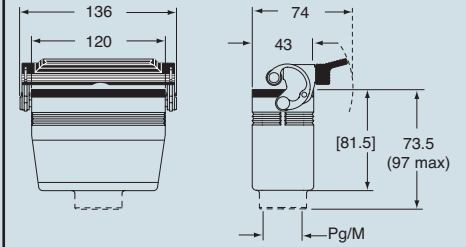

CRUS® Type 4/4X/12

dimensions indicated are not binding and may be changed without notice

size 104.27



inserts:		page
CD	64 poles + ⊕	45
CDD	108 poles + ⊕	58
CQE	46 poles + ⊕	77
CN	24 poles + ⊕	83
CCE	24 poles + ⊕	92
CNE, CSE.....	24 poles + ⊕	93
CSS	24 poles + ⊕	101
CMSE	10+2 (aux) poles + ⊕	118
CMCE	10+2 (aux) poles + ⊕	118
CX	4/8 poles + ⊕	133
MIXO	6 modules	137+151

insert centre distance: 104 x 27 mm

The covers for C, G and LG, versions cannot be used together with coding pins. If this application is required, please contact ILME SpA.

hoods with two levers



covers

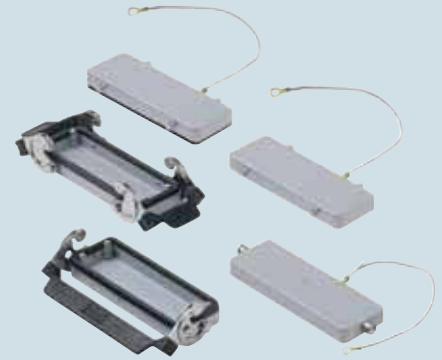

description	part No.		part No.		part No.
		entry Pg		entry M	
with levers, side entry ¹⁾	CHO 24 X	21	MHO 24 X25	25	
with levers, side entry ¹⁾			MHO 24 X32	32	
with levers, side entry, high construction ¹⁾	CAO 24 X	21	MAO 24 X32	32	
with levers, side entry, high construction ¹⁾	CAO 24 X29	29	MAO 24 X40	40	
with levers, top entry ¹⁾	CHV 24 X	21	MHV 24 X25	25	
with levers, top entry ¹⁾			MHV 24 X32	32	
with levers, top entry, high construction ¹⁾	CAV 24 X	21	MAV 24 X32	32	
with levers, top entry, high construction ¹⁾	CAV 24 X29	29	MAV 24 X40	40	
with 4 pegs (for enclosures with 2 levers with gasket)					CHC 24
with 4 pegs and gasket (for enclosures with 2 levers) ²⁾					CHC 24 C
with 2 pegs (for enclosures with 1 lever with gasket)					CHC 24 L
with 2 levers (for hoods with 4 pegs)					CHC 24 G
with 1 lever (for hoods with 2 pegs)					CHC 24 LG

¹⁾ May be combined with housings:
 - CHI/CHP/CAP 24 CS/CP/C
 - MHP/MAP 24 CS/CP

¹⁾ May be combined with housings:
 - CHO/CAO 24 X and CHV/CAV 24 X
 - MHO/MAO 24 X and MHV/MAV 24 X

dimensions in mm

CHO X (CAO X) and MHO X (MAO X)

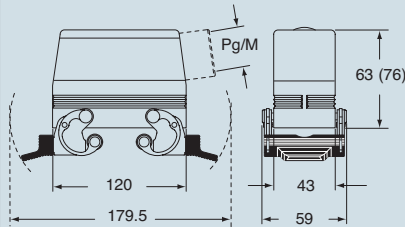

CHV X (CAV X) and MHV X (MAV X)

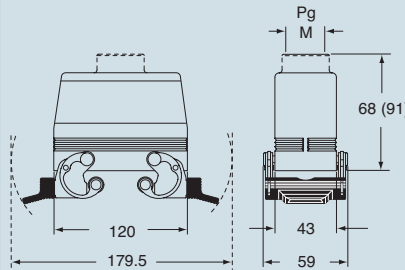

dimensions in mm

CHC



CHC C



CHC L

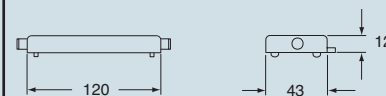

CHC G

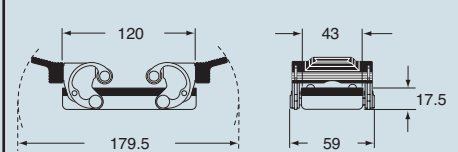

CHC LG

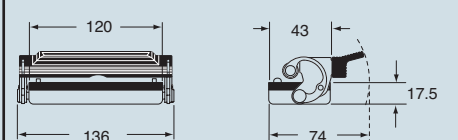

CAIUS® Type 4/4X/12

dimensions indicated are not binding and may be changed without notice

size 104.27



inserts:	page
CME 10 + 2 (aux) poles + ⊕	119
CME, CMCE 16 + 2 (aux) poles + ⊕	124

insert centre distance:
104 x 27 mm

bulkhead mounting housings with 2 levers or 4 pegs



bulkhead mounting housings with single lever



description	part No.	part No.
with one or two levers	CMI 16	CMI 16 L
with pegs and aluminium cover ¹⁾	CMI 16 CS	
with pegs and plastic cover ¹⁾	CMI 16 CP	
with lever and cover		CMI 16 LS

¹⁾ May be combined with hoods:
- CMO/CMAO 16 X and CMV/CMAV 16 X
- MMO/MMAO 16 X and MMV/MMAV 16 X

N.B.: the enclosures ensure IP66 protection (or IP65 cover versions) rating when mated and locked with the closing levers.
The cover (CS, CP) only ensures mechanical protection, but does not ensure IP65 protection rating.

panel cut-out for bulkhead mounting housings in mm



dimensions in mm

CMI

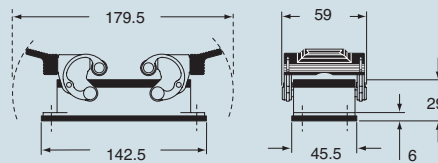

dimensions in mm

CMI L

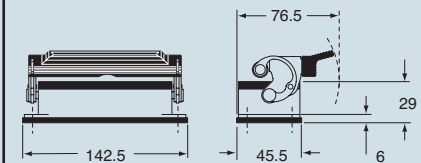

CMI CS/CP

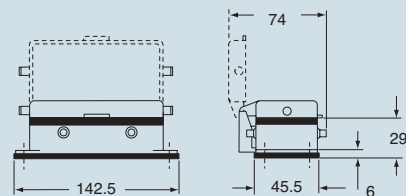

CMI LS

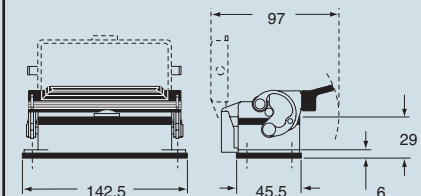

CALUS® Type 4/4X/12
(excluding enclosures with plastic cover)

dimensions indicated are not binding and may be changed without notice

size 104.27



inserts:	page
CME 10 + 2 (aux) poles + ⊕	119
CME, CMCE 16 + 2 (aux) poles + ⊕	124

insert centre distance:
104 x 27 mm

surface mounting housings with 2 levers or 4 pegs



surface mounting housings with single lever



description	part No.		part No.		part No.		part No.	
		entry Pg		entry M		entry Pg		entry M
with levers	CMP 16	21	MMP 16.25	25	CMP 16 L	21	MMP 16 L25	25
with levers	CMP 16.2	21 x 2	MMP 16.225	25 x 2	CMP 16 L2	21 x 2	MMP 16 L225	25 x 2
with levers, high construction	CMAP 16.21	21	MMAP 16.32	32	CMAP 16 L	21	MMAP 16 L32	32
with levers, high construction	CMAP 16.221	21 x 2	MMAP 16.232	32 x 2	CMAP 16 L2	21 x 2	MMAP 16 L232	32 x 2
with levers, high construction	CMAP 16.29	29	MMA 16.40	40	CMAP 16 L29	29	MMA 16 L40	40
with levers, high construction	CMAP 16.229	29 x 2	MMA 16.240	40 x 2	CMAP 16 L229	29 x 2	MMA 16 L240	40 x 2
with pegs and aluminium cover ¹⁾	CMP 16 CS	21	MMP 16 CS25	25				
with pegs and aluminium cover ¹⁾	CMP 16 CS2	21 x 2	MMP 16 CS225	25 x 2				
with pegs and aluminium cover, high construction ¹⁾	CMAP 16 CS	21	MMA 16 CS32	32				
with pegs and aluminium cover, high construction ¹⁾	CMAP 16 CS2	21 x 2	MMA 16 CS232	32 x 2				
with pegs and aluminium cover, high construction ¹⁾	CMA 16 CS29	29	MMA 16 CS40	40				
with pegs and aluminium cover, high construction ¹⁾	CMA 16 CS229	29 x 2	MMA 16 CS240	40 x 2				
with pegs and plastic cover ¹⁾	CMP 16 CP	21	MMP 16 CP25	25				
with pegs and plastic cover ¹⁾	CMP 16 CP2	21 x 2	MMP 16 CP225	25 x 2				
with pegs and plastic cover, high construction ¹⁾	CMA 16 CP	21	MMA 16 CP32	32				
with pegs and plastic cover, high construction ¹⁾	CMA 16 CP2	21 x 2	MMA 16 CP232	32 x 2				
with pegs and plastic cover, high construction ¹⁾	CMA 16 CP29	29	MMA 16 CP40	40				
with pegs and plastic cover, high construction ¹⁾	CMA 16 CP229	29 x 2	MMA 16 CP240	40 x 2				
with lever and cover					CMP 16 LS	21	MMP 16 LS25	25
with lever and cover					CMP 16 LS2	21 x 2	MMP 16 LS225	25 x 2
with lever and cover, high construction					CMA 16 LS	21	MMA 16 LS32	32
with lever and cover, high construction					CMA 16 LS2	21 x 2	MMA 16 LS232	32 x 2
with lever and cover, high construction					CMA 16 LS29	29	MMA 16 LS40	40
with lever and cover, high construction					CMA 16 LS229	29 x 2	MMA 16 LS240	40 x 2

¹⁾ May be combined with hoods:
- CMO/CMAO 16 X and CMV/CMAV 16 X
- MMO/MMAO 16 X and MMV/MMAV 16 X

N.B.: the enclosures ensure IP66 protection (or IP65 cover versions) rating when mated and locked with the closing levers.

The cover (CS, CP) only ensures mechanical protection, but does not ensure IP65 protection rating.

dimensions in mm

CMP - CMAP and MMP - MMAP

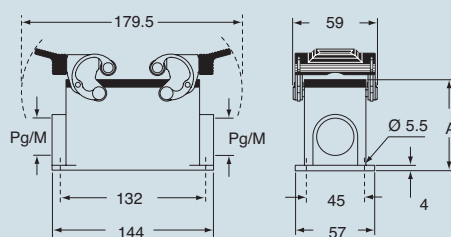

CMP CS/CP - CMAP CS/CP and MMP CS/CP - MMAP CS/CP

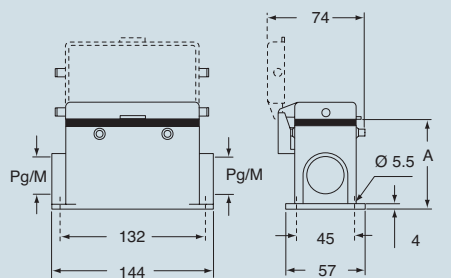

type	A
CMP / MMP	63
CMA / MMA	81
CMP CS / MMP CS	63
CMA CS / MMA CS	81
CMP CP / MMP CP	63
CMA CP / MMA CP	81

dimensions in mm

CMP L - CMAP L and MMP L - MMAP L

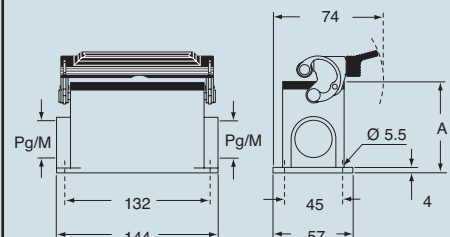

CMP LS - CMAP LS and MMP LS - MMAP LS

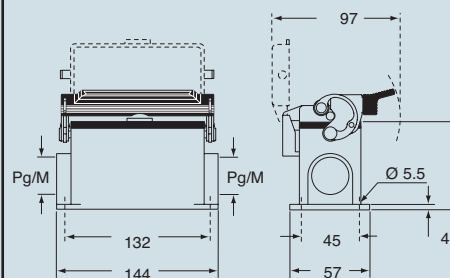

type	A
CMP L / MMP L	63
CMA L / MMA L	81
CMP LS / MMP LS	63
CMA LS / MMA LS	81

CMAUS® Type 4/4X/12

(excluding enclosures with plastic cover)

dimensions indicated are not binding and may be changed without notice

size 104.27



inserts:	page
CME 10 + 2 (aux) poles + ⊕	119
CME, CMCE 16 + 2 (aux) poles + ⊕	124

insert centre distance:
104 x 27 mm

hoods with 4 pegs



hoods with 2 pegs



description	part No.		part No.		part No.		part No.	
		entry Pg		entry M		entry Pg		entry M
with pegs, side entry	CMO 16	21	MMO 16.25	25	CMO 16 L	21	MMO 16 L25	25
with pegs, side entry			MMO 16.32	32			MMO 16 L32	32
with pegs, side entry, high construction	CMAO 16.21	21	MMAO 16.32	32	CMAO 16 L21	21	MMAO 16 L32	32
with pegs, side entry, high construction	CMAO 16.29	29	MMAO 16.40	40	CMAO 16 L29	29	MMAO 16 L40	40
with pegs, top entry	CMV 16	21	MMV 16.25 **	25	CMV 16 L	21	MMV 16 L25	25
with pegs, top entry			MMV 16.32	32			MMV 16 L32	32
with pegs, top entry	CMV 16.29	29	MMV 16.40	40	CMV 16 L29	29	MMV 16 L40	40
with pegs, top entry, high construction	CMAV 16.21	21	MMAV 16.32	32	CMAV 16 L21	21	MMAV 16 L32	32
with pegs, top entry, high construction	CMAV 16.29	29	MMAV 16.40	40	CMAV 16 L29	29	MMAV 16 L40	40
with pegs, frontal entry, high construction	CMAF 16.21	21	MMAF 16.25	25				
with pegs, frontal entry, high construction	CMAF 16.29	29	MMAF 16.32	32				
with pegs, frontal entry, high constr., without adaptor *	CMFF 16.21	21	MMFF 16.25	25				
with pegs, frontal entry, high constr., without adaptor *	CMFF 16.29	29	MMFF 16.32	32				

* enclosure without adaptor, threaded on the body, to be used only with a complete cable clamp.

** can only be used with a complete cable clamp (to be purchased separately)

dimensions in mm

CMO (CMAO) and MMO (MMAO)

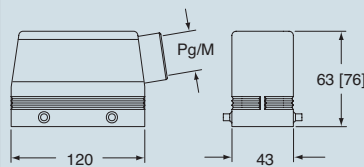

dimensions in mm

CMO L (CMAO L) and MMO L (MMAO L)

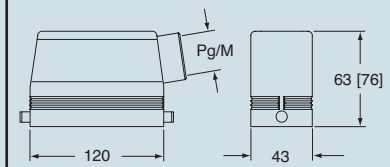

CMV (CMAV) and MMV (MMAV)

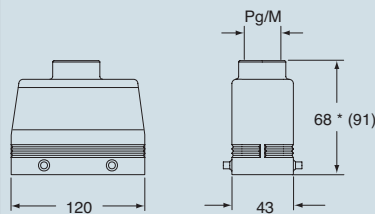

* 69.5 for Pg 29 - M 40 versions

CMV L (CMAV L) and MMV L (MMAV L)

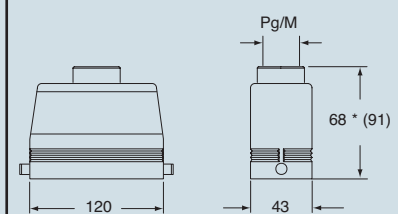

* 69.5 for Pg 29 - M 40 versions

CMAF/CMFF and MMAF/MMFF

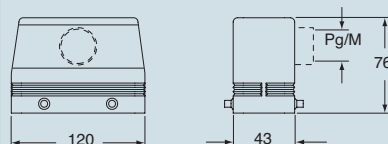

CAIUS® Type 4/4X/12

dimensions indicated are not binding and may be changed without notice

size 104.27



inserts: page

CME 10 + 2 (aux) poles + ⊕ 119
CME, CMCE 16 + 2 (aux) poles + ⊕ 124

insert centre distance:
104 x 27 mm

hoods with 2 levers



hoods with single lever



description	part No.		entry		part No.		entry	
			Pg	M			Pg	M
with levers and gasket, top entry	CMV 16 G	21	MMV 16 G32	32	CMV 16 LG	21	MMV 16 LG32	32
with levers and gasket, top entry, high construction	CMAV 16 G	21	MMAV 16 G25	25	CMAV 16 LG21	21	MMAV 16 LG25	25
with levers and gasket, top entry, high construction	CMAV 16 G29	29	MMAV 16 G32	32	CMAV 16 LG29	29	MMAV 16 LG32	32
with levers and gasket, top entry, high constr., without adaptor *	CMFV 16 G	21	MMFV 16 G25	25	CMFV 16 LG21	21	MMFV 16 LG25	25
with levers and gasket, top entry, high constr., without adaptor *	CMFV 16 G29	29	MMFV 16 G32	32	CMFV 16 LG29	29	MMFV 16 LG32	32

* enclosure without adaptor, threaded on the body, to be used only with a complete cable clamp.

dimensions in mm

**CMV G (CMAV G) and [CMFV G],
 MMV G (MMAV G) and [MMFV G]**

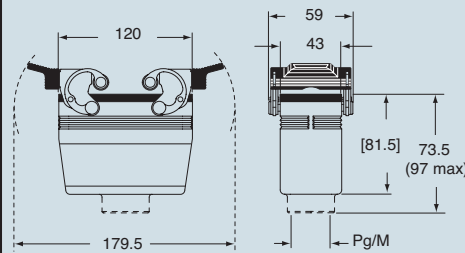

dimensions in mm

**CMV LG (CMAV LG) and [CMFV LG],
 MMV LG (MMAV LG) and [MMFV LG]**

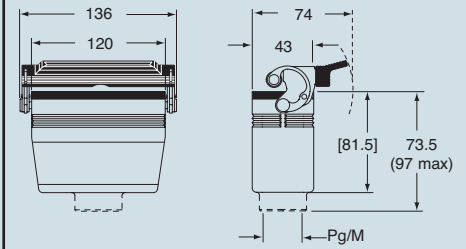

size 104.27

CAUS® Type 4/4X/12

dimensions indicated are not binding and may be changed without notice



inserts:	page
CME 10 + 2 (aux) poles + ⊕	119
CME, CMCE 16 + 2 (aux) poles + ⊕	124

insert centre distance:
104 x 27 mm

Covers G and LG version are not suitable to be used with code pins. If this application is required please contact ILME SpA.

hoods with 2 levers



covers

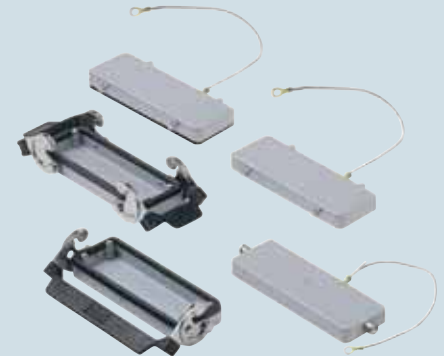

description	part No.	entry Pg	part No.	entry M	part No.
with levers, side entry ¹⁾	CMO 16 X	21	MMO 16 X25	25	
with levers, side entry ¹⁾			MMO 16 X32	32	
with levers, side entry, high construction ¹⁾	CMAO 16 X	21	MMAO 16 X32	32	
with levers, side entry, high construction ¹⁾	CMAO 16 X29	29	MMAO 16 X40	40	
with levers, top entry ¹⁾	CMV 16 X	21	MMV 16 X25	25	
with levers, top entry ¹⁾			MMV 16 X32	32	
with levers, top entry, high construction ¹⁾	CMAV 16 X	21	MMAV 16 X32	32	
with levers, top entry, high construction ¹⁾	CMAV 16 X29	29	MMAV 16 X40	40	
with 4 pegs (for enclosures with 2 levers with gasket)					CHC 24
with 4 pegs and gasket (for enclosures with 2 levers) ²⁾					CHC 24 C
with 2 pegs (for enclosures with 1 lever with gasket)					CHC 24 L
with 2 levers (for hoods with 4 pegs)					CHC 24 G
with 1 lever (for hoods with 2 pegs)					CHC 24 LG

¹⁾ May be combined with housings:
- CMI/CMP/CMAV 16 CS
- MMP/MMAV 16 CS

²⁾ May be combined with housings:
- CMO/CMAO 16 X and CMV/CMAV 16 X
- MMO/MMAO 16 X and MMV/MMAV 16 X

dimensions in mm

CMO X (CMAO X) and MMO X (MMAO X)

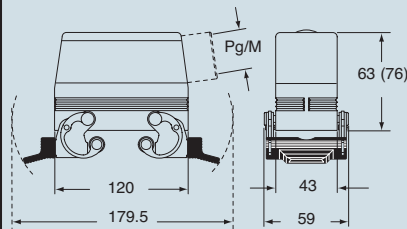

CMV X (CMAV X) and MMV X (MMAV X)

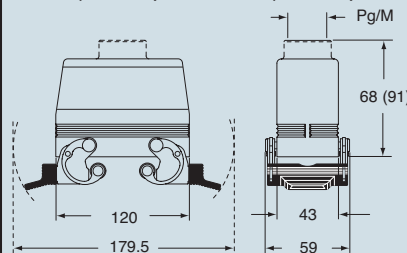

dimensions in mm

CHC



CHC C



CHC L

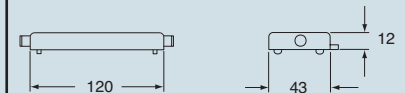

CHC G

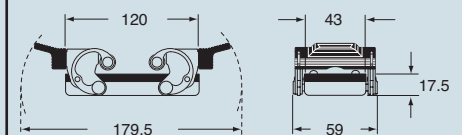

CHC LG

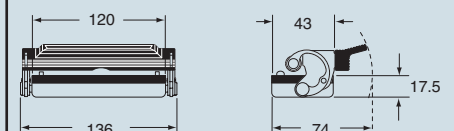

CALUS® Type 4/4X/12

dimensions indicated are not binding and may be changed without notice

size 104.27



inserts:	page
CN RY 24 poles + ⊕	83
CNE RY 24 poles + ⊕	93
CP RY 6 poles + ⊕	127

insert centre distance:
104 x 27 mm

The covers for G versions cannot be used together with coding pins. If this application is required, please contact ILME SpA.

housings and cover

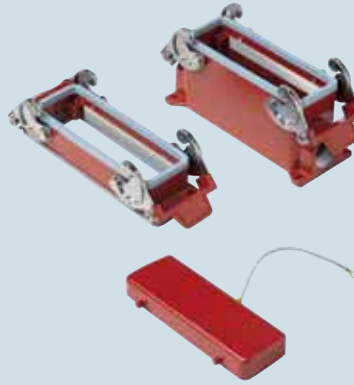

hoods and cover



description	part No.	entry Pg	part No.	entry M	part No.	entry Pg	part No.	entry M
bulkhead mounting, with levers	CHIR 24	---						
surface mounting, with levers, high construction	CAPR 24.21	21	MAPR 24.32	32				
cover with 4 pegs (for housings)	CHCR 24							
with pegs, side entry					CHOR 24	21	MHOR 24.25	25
with pegs, side entry, high construction					CAOR 24.29	29	MAOR 24.40	40
with pegs, top entry					CHVR 24	21	MHVR 24.25	25
with pegs, top entry, high construction					CAVR 24.29	29	MAVR 24.40	40
cover with 2 levers (for hoods)					CHCR 24 G			

panel cut-out for bulkhead mounting housings in mm

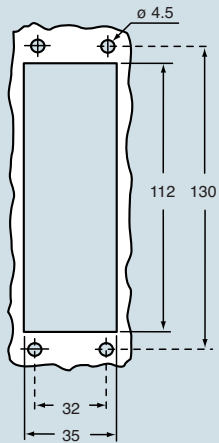

dimensions in mm

CHIR

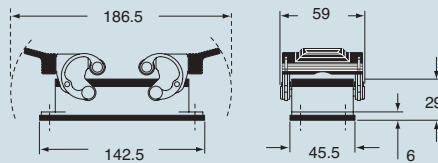

CAPR and MAPR

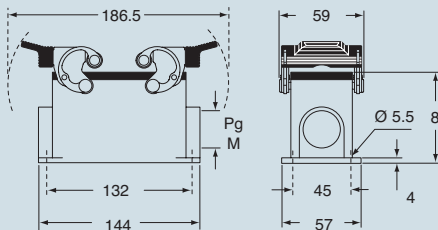

CHCR



dimensions in mm

CHOR (CAOR) and MHOR (MAOR)

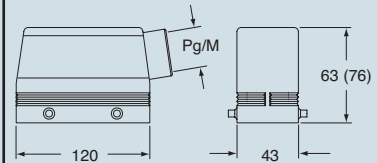

CHVR (CAVR) and MHVR (MAVR)

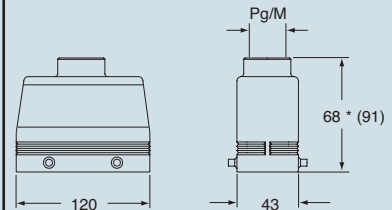

* 69.5 for Pg 29 - M 40 versions

CHCR G

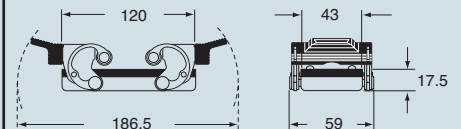

CAUS® Type 4/4X/12

dimensions indicated are not binding and may be changed without notice

size 104.27



inserts:		page
CD	64 poles + ⊕	45
CT, CTS *) (10A)	64 poles + ⊕	51
CDD	108 poles + ⊕	58
CQE	46 poles + ⊕	77
CN	24 poles + ⊕	83
CCE	24 poles + ⊕	92
CNE, CSE	24 poles + ⊕	93
CSS	24 poles + ⊕	101
CTE, CTSE *) (16A)	24 poles + ⊕	109
CMSE	10+2 (aux) poles + ⊕	118
CMCE	10+2 (aux) poles + ⊕	118
CME	10+2 (aux) poles + ⊕	119
CME	16+2 (aux) poles + ⊕	124
CMCE	16+2 (aux) poles + ⊕	124
CX	4/8 poles + ⊕	133
MIXO	6 modules	137÷151

insert centre distance: 104 x 27 mm

*) only for enclosure CHIW 24

housings and cover

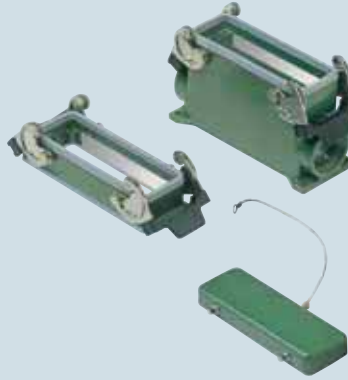

hoods and cover



description	part No.	entry Pg	part No.	entry M	part No.	entry Pg	part No.	entry M
bulkhead mounting, with levers	CHIW 24	---						
surface mounting, with levers, high construction	CAPW 24.21	21	MAPW 24.32	32				
cover with 4 pegs (for enclosures with 2 levers)	CHCW 24							
with pegs, side entry					CHOW 24	21	MHOW 24.25	25
with pegs, side entry, high construction					CAOW 24.29	29	MHOW 24.32	32
with pegs, side entry, high construction							MAOW 24.32	32
with pegs, top entry					CHVW 24	21	MAOW 24.40	40
with pegs, top entry, high construction							MHVW 24.25	25
with pegs, top entry, high construction					CAVW 24.29	29	MHVW 24.32	32
with pegs, top entry, high construction							MAVW 24.32	32
with pegs, top entry, high construction							MAVW 24.40	40
cover with 2 levers (for enclosures with 4 pegs)					CHCW 24 G			
with lever and gasket, top entry					CHVW 24 G	21	MHVW 24 G32	32

panel cut-out for bulkhead mounting housings in mm

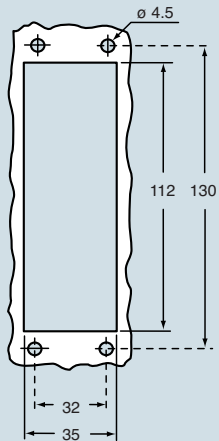

The covers for G versions cannot be used together with coding pins. If this application is required, please contact ILME SpA.

ILME® Type 4/4X/12

dimensions indicated are not binding and may be changed without notice

dimensions in mm

CHIW

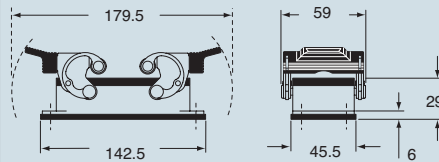

CAPW and MAPW

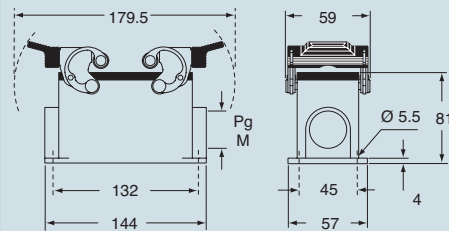

CHCW

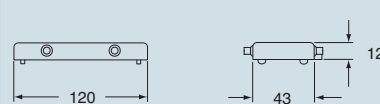

dimensions in mm

CHOW (CAOW) and MHOW (MAOW)

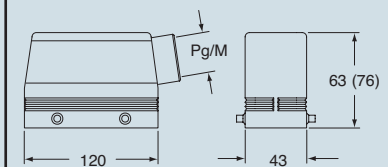

CHVW (CAVW) and MHVW (MAVW)

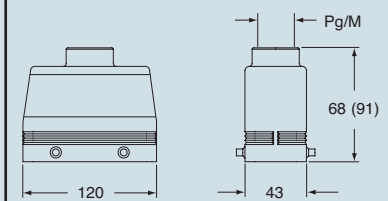

CHCW G

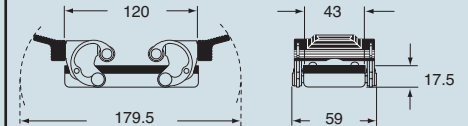

CHVW G and MHVW G

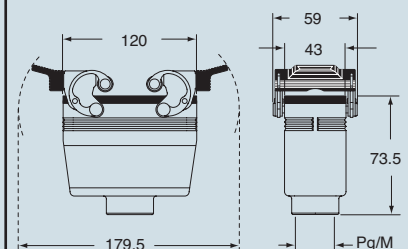



inserts:		page
CD	64 poles + ⊕	45
CT, CTS *) (10A)	64 poles + ⊕	51
CDD	108 poles + ⊕	58
CQE	46 poles + ⊕	77
CN	24 poles + ⊕	83
CCE	24 poles + ⊕	92
CNE, CSE.....	24 poles + ⊕	93
CSS	24 poles + ⊕	101
CTE, CTSE *) (16A) 24	poles + ⊕	109
CMSE	10+2 (aux) poles + ⊕	118
CMCE	10+2 (aux) poles + ⊕	118
CX	4/8 poles + ⊕	133
MIXO	6 modules	137÷151

insert centre distance: 104 x 27 mm

*) only for enclosure CHIS 24

housings and cover for electromagnetic compatibility

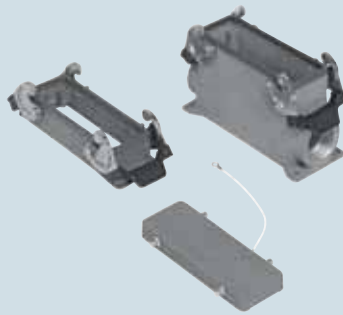

hoods and cover for electromagnetic compatibility



description	part No.		part No.		part No.		part No.	
	entry Pg	entry M	entry Pg	entry M	entry Pg	entry M	entry Pg	entry M
bulkhead mounting, with levers	CHIS 24	---						
surface mounting, with levers, high construction	CAPS 24.21	21	MAPS 24.32	32				
cover with 4 pegs (for enclosures with 2 levers)	CHCS 24							
with pegs, side entry					CHOS 24	21	MHOS 24.25	25
with pegs, side entry, high construction					CAOS 24.29	29	MHOS 24.32	32
with pegs, side entry, high construction							MAOS 24.32	32
with pegs, top entry					CHVS 24	21	MAOS 24.40	40
with pegs, top entry, high construction							MHVS 24.25	25
with pegs, top entry, high construction					CAVS 24.29	29	MHVS 24.32	32
with pegs, top entry, high construction							MAVS 24.32	32
with pegs, top entry, high construction							MAVS 24.40	40
cover with 2 levers (for enclosures with 4 pegs)					CHCS 24 G			

panel cut-out for bulkhead mounting housings in mm

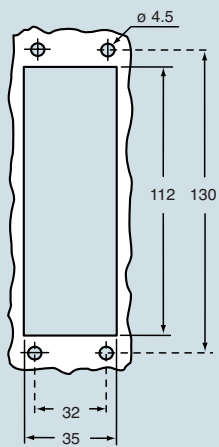

dimensions in mm

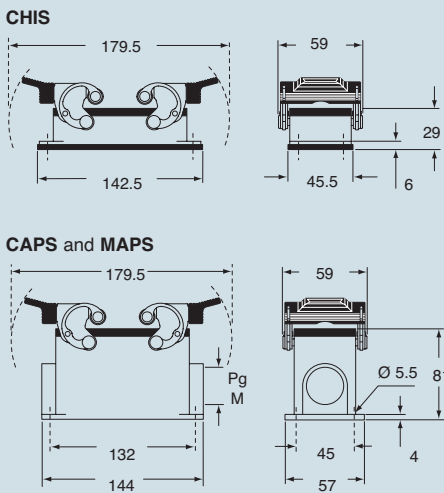

dimensions in mm

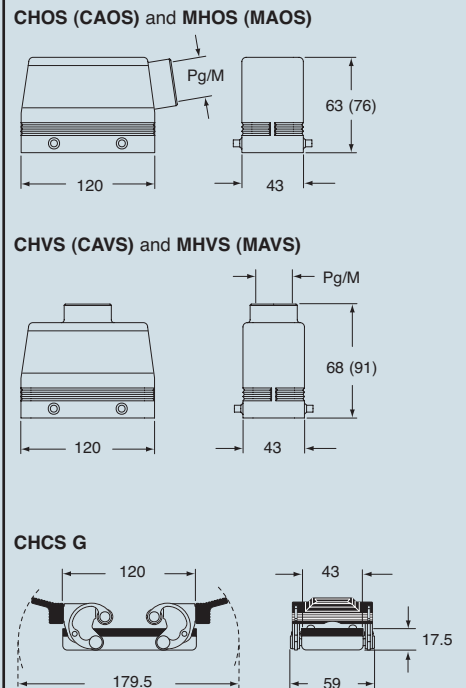

The covers for G versions cannot be used together with coding pins. If this application is required, please contact ILME SpA.



dimensions indicated are not binding and may be changed without notice

size 77.27

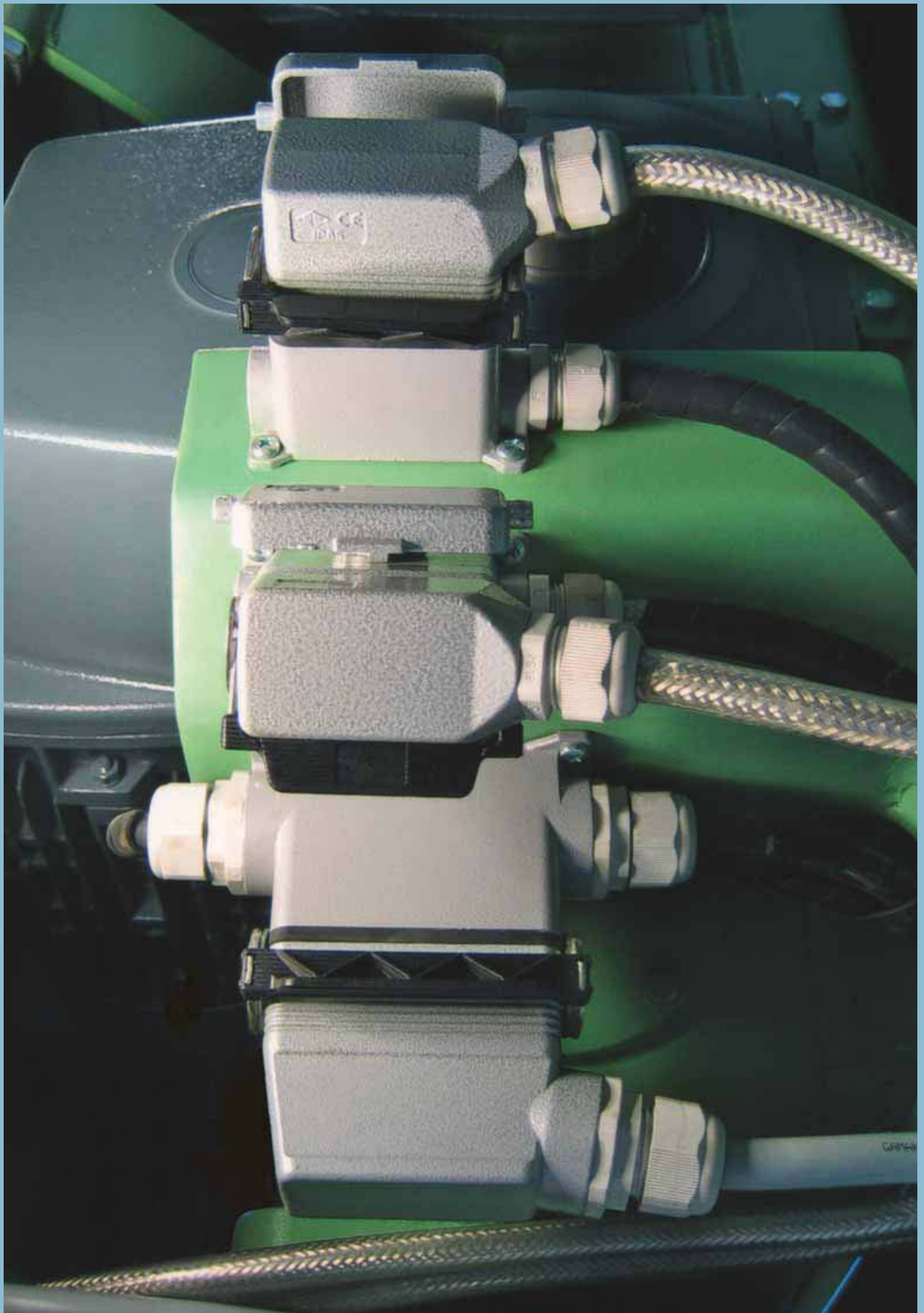



inserts:		page
CD	80 poles + ⊕	46
CDD	144 poles + ⊕	59
CQE	64 poles + ⊕	78
CN	32 poles + ⊕	84
CCE	32 poles + ⊕	94
CNE, CSE.....	32 poles + ⊕	95
CSS	32 poles + ⊕	102
CMSE	12+4 (aux) poles + ⊕	120
CMCE	12+4 (aux) poles + ⊕	120
CME	12+4 (aux) poles + ⊕	121
CP.....	12 poles + ⊕	128
MIXO	4 + 4 modules	137÷151

insert centre distance:
2 x (77.5 x 27) mm

bulkhead mounting housings with 2 levers or 4 pegs



bulkhead mounting housings with single lever



description	part No.	part No.
with one or two levers	CHI 32	CHI 32 L
with pegs and cover ¹⁾	CHI 32 CS	
with lever and cover		CHI 32 LS

¹⁾ May be combined with hoods:
- CHO/CHV/CFO/CFV 32 X
- MHO/MHV/MFO/MFV 32 X

N.B.: the enclosures ensure IP66 protection (or IP65 cover versions) rating when mated and locked with the closing levers.
The cover (CS, CP) only ensures mechanical protection, but does not ensure IP65 protection rating.

panel cut-out for bulkhead mounting housings in mm

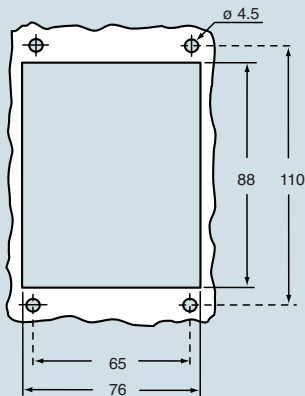

dimensions in mm

CHI

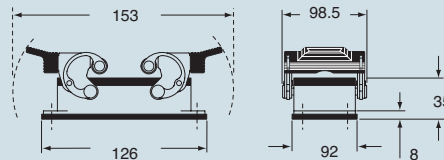

CHI CS

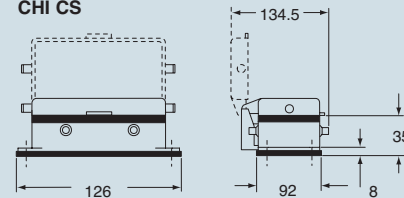

dimensions in mm

CHI L

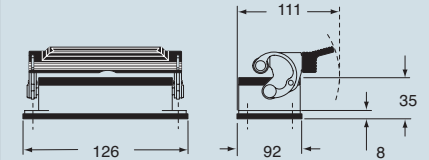

CHI LS

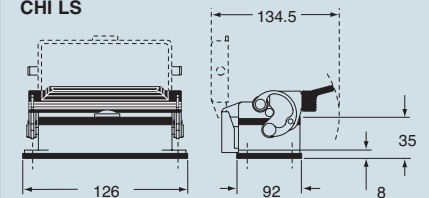

CAUS® Type 4/4X/12

dimensions indicated are not binding and may be changed without notice

size 77.62



inserts:		page
CD	80 poles + ⊕	46
CDD	144 poles + ⊕	59
CQE	64 poles + ⊕	78
CN	32 poles + ⊕	84
CCE	32 poles + ⊕	94
CNE, CSE.....	32 poles + ⊕	95
CSS	32 poles + ⊕	102
CMSE	12+4 (aux) poles + ⊕	120
CMCE	12+4 (aux) poles + ⊕	120
CME	12+4 (aux) poles + ⊕	121
CP.....	12 poles + ⊕	128
MIXO	4 + 4 modules	137÷151

insert centre distance:
2 x (77.5 x 27) mm

surface mounting housings with 2 levers



surface mounting housings with single lever



description	part No.		entry		part No.		entry	
			Pg	M			Pg	M
with one or two levers	CHP 32.29		29		MHP 32.40		29	40
with one or two levers	CHP 32.229		29 x 2		MHP 32.240		29 x 2	40 x 2
with one or two levers	CHP 32		36		MHP 32.50		36	50
with one or two levers	CHP 32.2		36 x 2		MHP 32.250		36 x 2	50 x 2
with one or two levers	CHP 32.42		42		CHP 32 L2		36 x 2	50 x 2
with one or two levers	CHP 32.242		42 x 2		CHP 32 L42		42	
					CHP 32 L242		42 x 2	
with lever and cover					CHP 32 LS29		29	40
with lever and cover					CHP 32 LS229		29 x 2	40 x 2
with lever and cover					CHP 32 LS		36	50
with lever and cover					CHP 32 LS2		36 x 2	50 x 2
with lever and cover					CHP 32 LS42		42	
with lever and cover					CHP 32 LS242		42 x 2	
					MHP 32 LS40		40	
					MHP 32 LS240		40 x 2	
					MHP 32 LS50		50	
					MHP 32 LS250		50 x 2	

N.B.: the enclosures ensure IP66 protection (or IP65 cover versions) rating when mated and locked with the closing levers.
The cover (CS, CP) only ensures mechanical protection, but does not ensure IP65 protection rating.

dimensions in mm

CHP and MHP

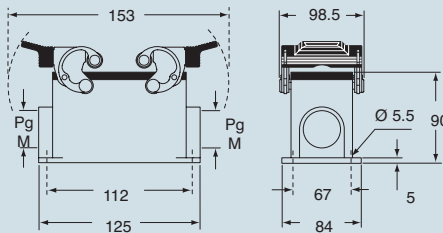

dimensions in mm

CHP L and MHP L

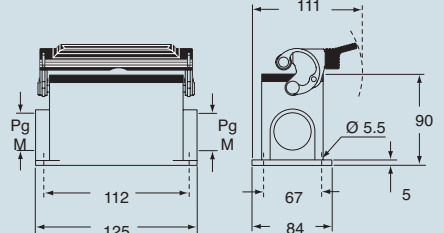

CHP LS and MHP LS

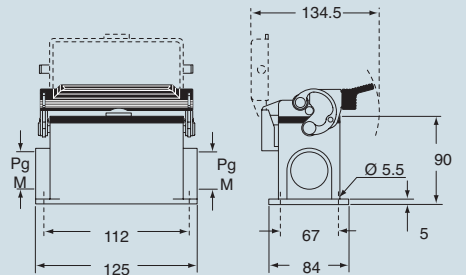

dimensions indicated are not binding and may be changed without notice

size 77.62



inserts:		page
CD	80 poles + ⊕	46
CDD	144 poles + ⊕	59
CQE	64 poles + ⊕	78
CN	32 poles + ⊕	84
CCE	32 poles + ⊕	94
CNE, CSE.....	32 poles + ⊕	95
CSS	32 poles + ⊕	102
CMSE	12+4 (aux) poles + ⊕	120
CMCE	12+4 (aux) poles + ⊕	120
CME	12+4 (aux) poles + ⊕	121
CP.....	12 poles + ⊕	128
MIXO	4 + 4 modules	137÷151

insert centre distance:
2 x (77.5 x 27) mm

hoods with 2 levers or 4 pegs



hoods with single lever or 2 pegs



description	part No.		part No.		part No.		part No.	
		entry Pg		entry M		entry Pg		entry M
with pegs, side entry	CHO 32.29	29	MHO 32.32	32	CHO 32 L	36	MHO 32 L40	40
with pegs, side entry	CHO 32	36	MHO 32.40	40				
with pegs, side entry	CHO 32.42	42	MHO 32.50	50				
with pegs, side entry, without adaptor *	CFO 32.29	29	MFO 32.32	32	CFO 32 L	36	MFO 32 L40	40
with pegs, side entry, without adaptor *	CFO 32	36	MFO 32.40	40				
with pegs, side entry, without adaptor *	CFO 32.42	42	MFO 32.50	50				
with pegs, top entry	CHV 32.29	29	MHV 32.32	32	CHV 32 L	36	MHV 32 L40	40
with pegs, top entry	CHV 32	36	MHV 32.40	40				
with pegs, top entry	CHV 32.42	42	MHV 32.50	50				
with pegs, top entry, without adaptor *	CFV 32.29	29	MFV 32.32	32	CFV 32 L	36	MFV 32 L40	40
with pegs, top entry, without adaptor *	CFV 32	36	MFV 32.40	40				
with pegs, top entry, without adaptor *	CFV 32.42	42	MFV 32.50	50				
with levers and gasket, top entry	CHV 32 G29	29	MHV 32 G32	32	CHV 32 LG	36	MHV 32 LG40	40
with one or two levers and gasket, top entry	CHV 32 G	36	MHV 32 G40	40				
with levers and gasket, top entry	CHV 32 G42	42	MHV 32 G50	50				
with levers and gasket, top entry, without adaptor *	CFV 32 G29	29	MFV 32 G32	32	CFV 32 LG	36	MFV 32 LG40	40
with one or two levers and gasket, top entry, without adaptor *	CFV 32 G	36	MFV 32 G40	40				
with levers and gasket, top entry, without adaptor *	CFV 32 G42	42	MFV 32 G50	50				

* enclosure without adaptor, threaded on the body, to be used only with a complete cable clamp.

dimensions in mm

CHO/CFO and MHO/MFO

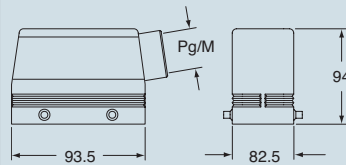

dimensions in mm

CHO/CFO L and MHO/MFO L

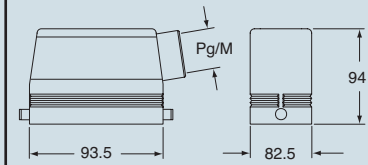

CHV/CFV and MHV/MFV

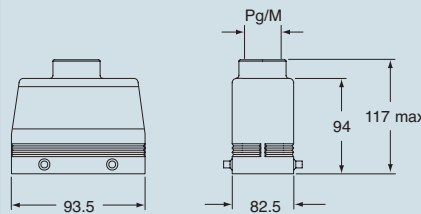

CHV/CFV L and MHV/MFV L

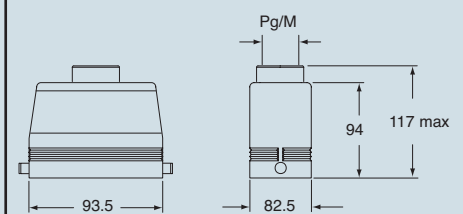

CHV/CFV G and MHV/MFV G

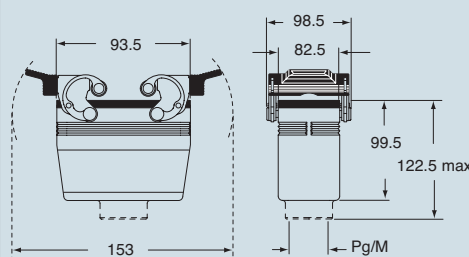

CHV/CFV LG and MHV/MFV LG

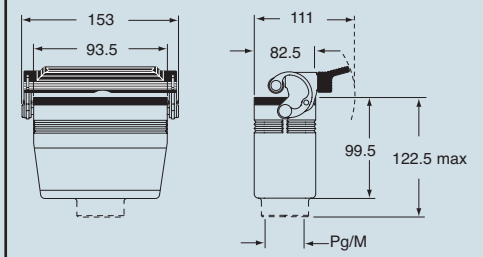

dimensions indicated are not binding and may be changed without notice

size 77.62



inserts:		page
CD	80 poles + ⊕	46
CDD	144 poles + ⊕	59
CQE	64 poles + ⊕	78
CN	32 poles + ⊕	84
CCE	32 poles + ⊕	94
CNE, CSE.....	32 poles + ⊕	95
CSS	32 poles + ⊕	102
CMSE	12+4 (aux) poles + ⊕	120
CMCE	12+4 (aux) poles + ⊕	120
CME	12+4 (aux) poles + ⊕	121
CP.....	12 poles + ⊕	128
MIXO	4 + 4 modules	137÷151

insert centre distance: 2 x (77.5 x 27) mm

The covers for C, G and LG versions cannot be used together with coding pins. If this application is required, please contact ILME SpA.

hoods with 2 levers



covers



description	part No.	entry Pg	part No.	entry M	part No.
with levers, side entry ¹⁾	CHO 32 X	36	MHO 32 X40	40	
with levers, side entry, without adaptor * ¹⁾	CFO 32 X	36	MFO 32 X40	40	
with levers, top entry ¹⁾	CHV 32 X	36	MHV 32 X40	40	
with levers, top entry, without adaptor * ¹⁾	CFV 32 X	36	MFV 32 X40	40	
with 4 pegs (for enclosures with 2 levers with gasket) with 4 pegs and gasket (for enclosures with 2 levers) ²⁾ with 2 pegs (for enclosures with 1 lever with gasket)					CHC 32 CHC 32 C CHC 32 L
with 2 levers (for hoods with 4 pegs) with 1 lever (for hoods with 2 pegs)					CHC 32 G CHC 32 LG

* enclosure without adaptor, threaded on the body, to be used only with a complete cable clamp.

¹⁾ May be combined with CHI 32 CS housings

²⁾ May be combined with hoods:
- CHO/CFO 32 X and CHV/CFV 32 X
- MHO/MFO 32 X and MHV/MFV 32 X

dimensions in mm

CHO/CFO X and MHO/MFO X

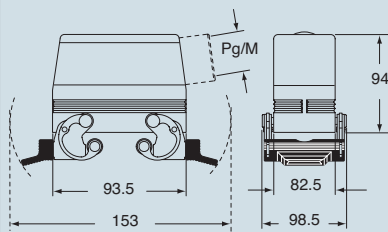

CHV/CFV X and MHV/MFV X

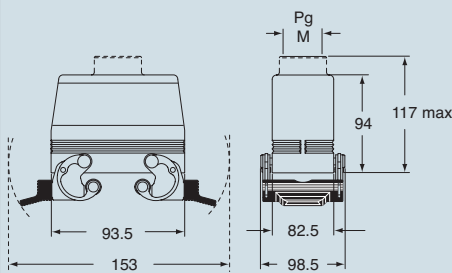

dimensions in mm

CHC



CHC C



CHC L

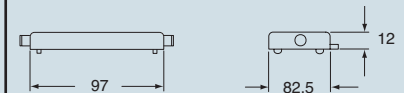

CHC G

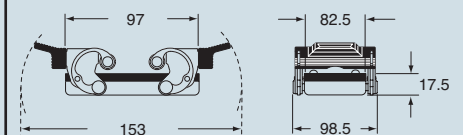

CHC LG

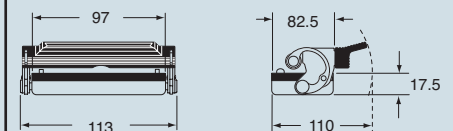

CAUS® Type 4/4X/12

dimensions indicated are not binding and may be changed without notice



inserts:		page
CD	80 poles + ⊕	46
CDD	144 poles + ⊕	59
CQE	64 poles + ⊕	78
CN	32 poles + ⊕	84
CCE	32 poles + ⊕	94
CNE, CSE	32 poles + ⊕	95
CSS	32 poles + ⊕	102
CMSE	12+4 (aux) poles + ⊕	120
CMCE	12+4 (aux) poles + ⊕	120
CME	12+4 (aux) poles + ⊕	121
CP	12 poles + ⊕	128
MIXO	4 + 4 modules	137÷151

insert centre distance: 2 x (77.5 x 27) mm

The covers for G versions cannot be used together with coding pins. If this application is required, please contact ILME SpA.

housings and cover

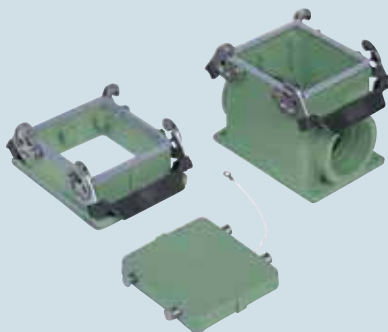

hoods and cover



description	part No.		part No.		part No.		part No.	
		entry Pg		entry M		entry Pg		entry M
bulkhead mounting, with levers	CHIW 32	---						
surface mounting, with levers	CHPW 32	36	MHPW 32.50	50				
cover with 4 pegs (for enclosures with 2 levers)	CHCW 32							
with pegs, side entry					CHOW 32	36	MHOW 32.40	40
with pegs, top entry					CHVW 32	36	MHVW 32.40	40
cover with 2 levers (for enclosures with 4 pegs)					CHCW 32 G			
with levers and gasket, top entry					CHVW 32 G	36	MHVW 32 G40	40

panel cut-out for bulkhead mounting housings in mm

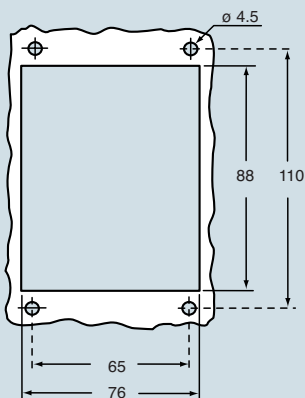

dimensions in mm

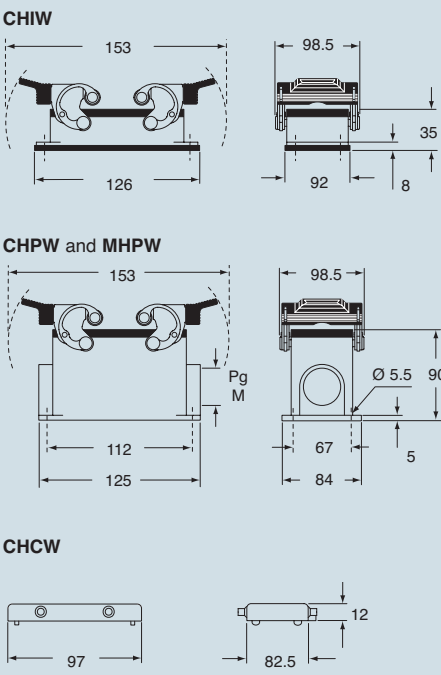

dimensions in mm

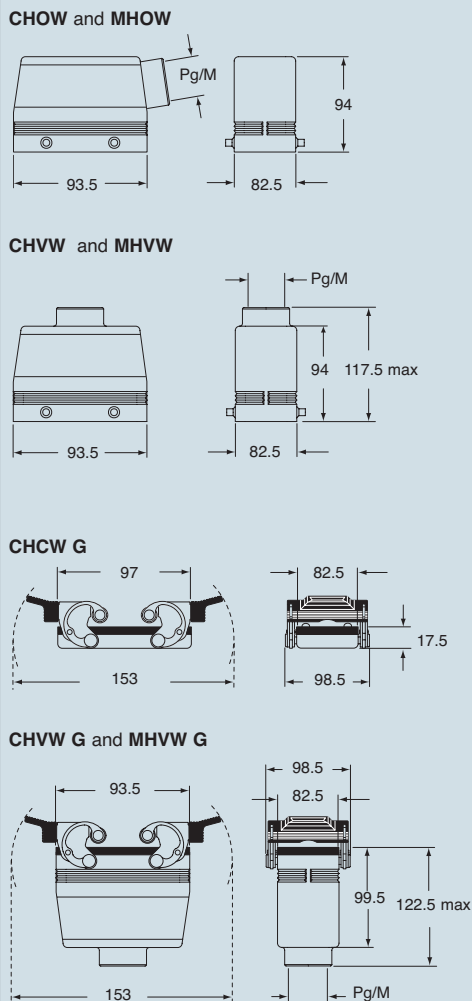

dimensions indicated are not binding and may be changed without notice

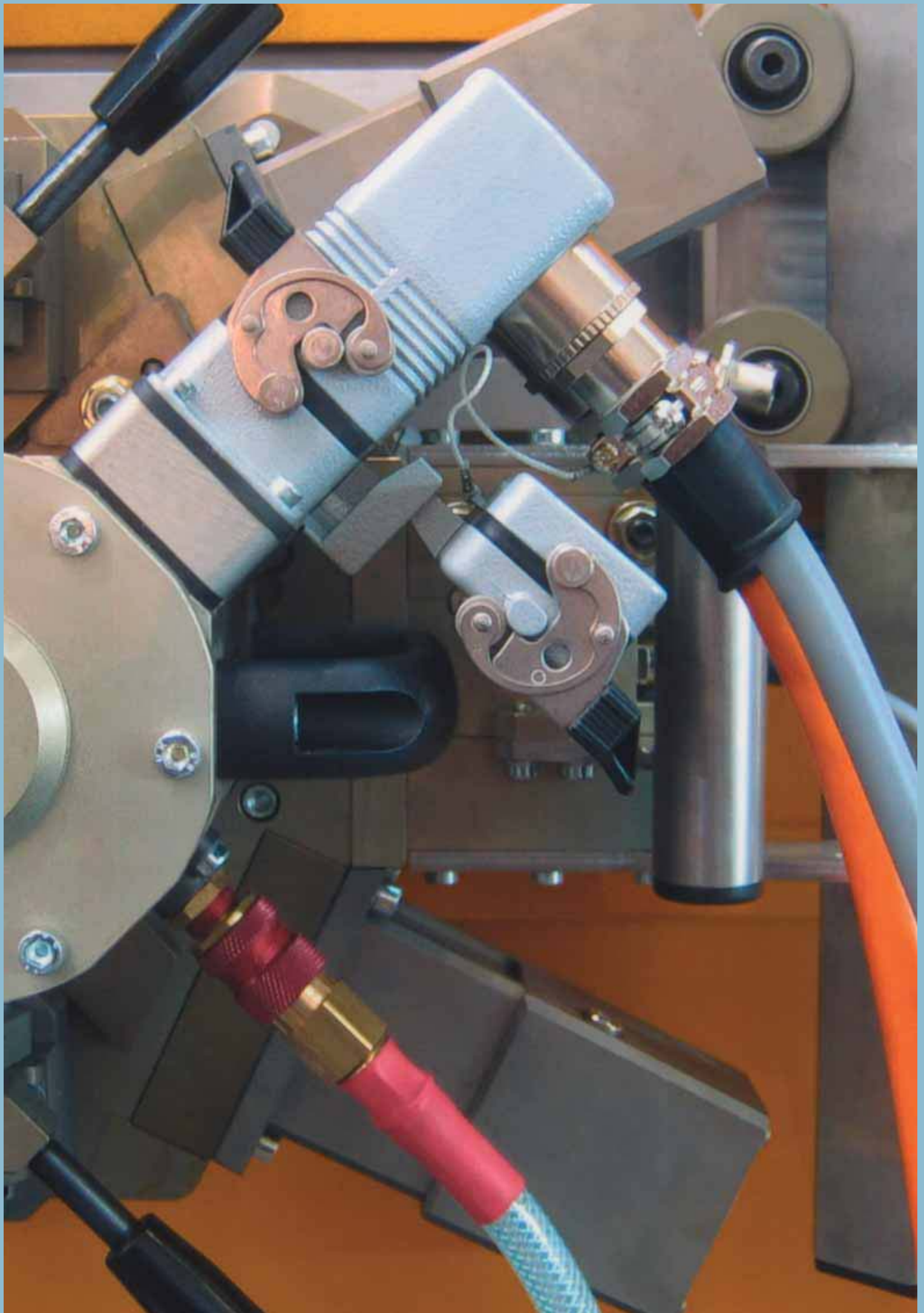



inserts:		page
CD	128 poles + ⊕	47
CDD	216 poles + ⊕	60
CQE	92 poles + ⊕	79
CN	48 poles + ⊕	85
CCE	48 poles + ⊕	96
CNE, CSE.....	48 poles + ⊕	97
CSS	48 poles + ⊕	103
CMSE	20+4 (aux) poles + ⊕	122
CMCE	20+4 (aux) poles + ⊕	122
CME	20+4 (aux) poles + ⊕	123
CME	32+4 (aux) poles + ⊕	125
CMCE	32+4 (aux) poles + ⊕	125
MIXO	6 + 6 modules	137÷151

insert centre distance:
2 x (104 x 27) mm

bulkhead and surface mounting housings with single lever



hoods for single lever



description	part No.	entry Pg	part No.	entry M	part No.	entry Pg	part No.	entry M
bulkhead mounting housings with lever	CHI 48 L	---						
bulkhead mounting housings with lever and cover	CHI 48 LS	---						
surface mounting housings with lever and cover	CHP 48 LS29	29 x 1/2	MHP 48 LS40	40 x 1/2				
surface mounting housings with lever and cover	CHP 48 LS	36 x 1/2	MHP 48 LS50	50 x 1/2				
with pegs, side entry					CHO 48 L29	29	MHO 48 L32	32
with pegs, side entry					CHO 48 L	36	MHO 48 L40	40
with pegs, side entry					CHO 48 L42	42	MHO 48 L50	50
with pegs, side entry, without adaptor *					CFO 48 L29	29	MFO 48 L32	32
with pegs, side entry, without adaptor *					CFO 48 L	36	MFO 48 L40	40
with pegs, side entry, without adaptor *					CFO 48 L42	42	MFO 48 L50	50
with pegs, top entry					CHV 48 L29	29	MHV 48 L32	32
with pegs, top entry					CHV 48 L	36	MHV 48 L40	40
with pegs, top entry					CHV 48 L42	42	MHV 48 L50	50
with pegs, top entry, without adaptor *					CFV 48 L29	29	MFV 48 L32	32
with pegs, top entry, without adaptor *					CFV 48 L	36	MFV 48 L40	40
with pegs, top entry, without adaptor *					CFV 48 L42	42	MFV 48 L50	50

* enclosure without adaptor, threaded on the body, to be used only with a complete cable clamp.

panel cut-out for bulkhead mounting housings in mm

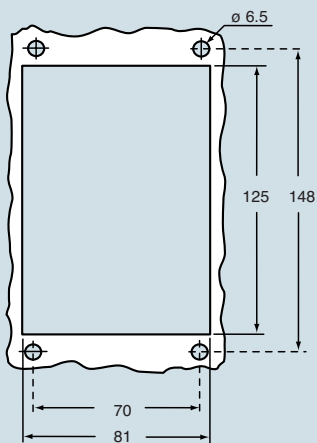

N.B.: the enclosures ensure IP66 protection (or IP65 cover versions) rating when mated and locked with the closing levers. The cover (CS, CP) only ensures mechanical protection, but does not ensure IP65 protection rating.

dimensions in mm

CHI L - LS

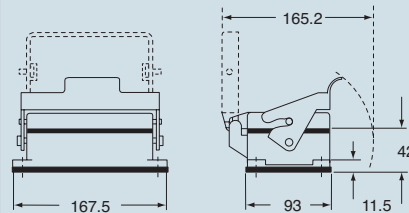

CHP LS and MHP LS

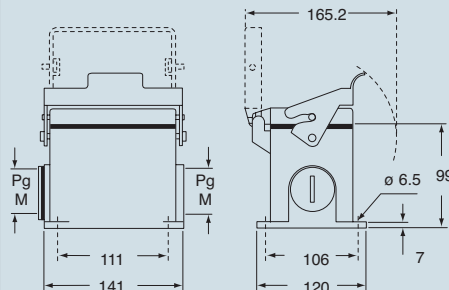

dimensions in mm

CHO/CFO L and MHO/MFO L

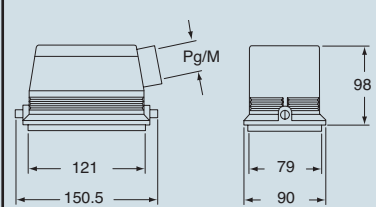

CHV/CFV L and MHV/MFV L

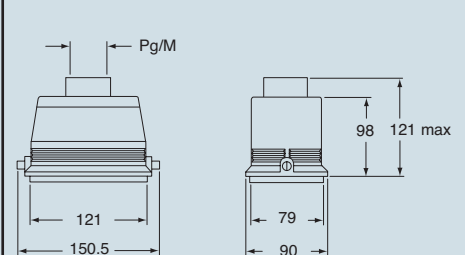

dimensions indicated are not binding and may be changed without notice



inserts:		page
CN RY	48 poles + ⊕	85
CNE RY	48 poles + ⊕	97

insert centre distance:
2 x (104 x 27) mm

housings



hoods



description	part No.		part No.		part No.		part No.	
	entry Pg	entry M	entry Pg	entry M	entry Pg	entry M	entry Pg	entry M
bulkhead mounting housings, with lever and cover	---	---	---	---	---	---	---	---
surface mounting housings, with lever and cover	---	---	---	---	---	---	---	---
with pegs, side entry					CHOR 48 L	36	MHOR 48 L40	40
with pegs, top entry					CHVR 48 L	36	MHVR 48 L40	40

panel cut-out for bulkhead mounting housings in mm

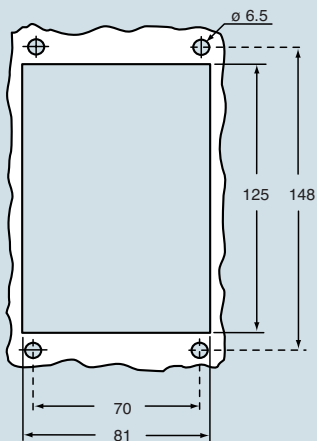

dimensions in mm

CHIR LS

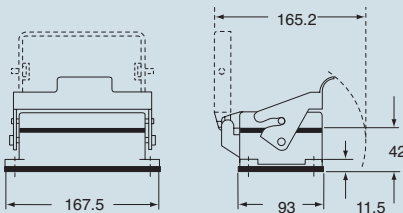

CHPR LS and MHPR LS

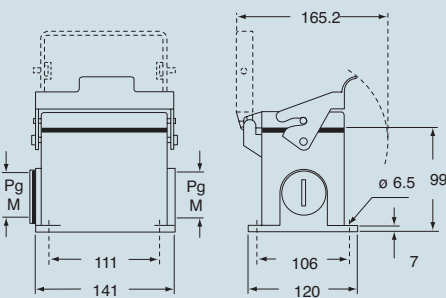

dimensions in mm

CHOR L and MHOR L

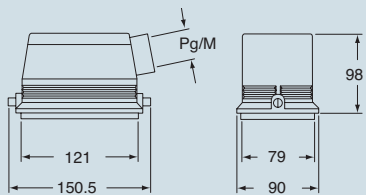

CHVR L and MHVR L

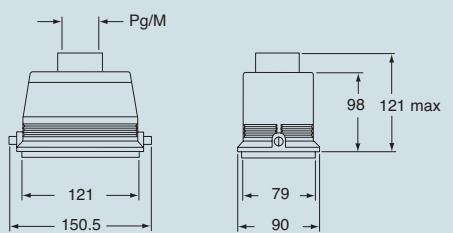

N.B.: the enclosures ensure IP66 protection (or IP65 cover versions) rating when mated and locked with the closing levers.
The cover (CS, CP) only ensures mechanical protection, but does not ensure IP65 protection rating.

CAUS® Type 4/4X/12

dimensions indicated are not binding and may be changed without notice

size 104.62



inserts:		page
CD	128 poles + ⊕	47
CDD	216 poles + ⊕	60
CQE	92 poles + ⊕	79
CN	48 poles + ⊕	85
CCE	48 poles + ⊕	96
CNE, CSE.....	48 poles + ⊕	97
CSS	48 poles + ⊕	103
CMSE	20+4 (aux) poles + ⊕	122
CMCE	20+4 (aux) poles + ⊕	122
CME	20+4 (aux) poles + ⊕	123
CME	32+4 (aux) poles + ⊕	125
CMCE	32+4 (aux) poles + ⊕	125
MIXO	6 + 6 modules	137+151

insert centre distance:
2 x (104 x 27) mm

housings



hoods



description	part No.	entry Pg	part No.	entry M	part No.	entry Pg	part No.	entry M
bulkhead mounting housings, with lever and cover	CHIW 48 LS	---						
surface mounting housings, with lever and cover	CHPW 48 LS	36 x 1/2	MHPW 48 LS40	40 x 1/2				
with pegs, side entry					CHOW 48 L	36	MHOW 48 L40	40
with pegs, top entry					CHVW 48 L	36	MHVW 48 L40	40

panel cut-out for bulkhead mounting housings in mm

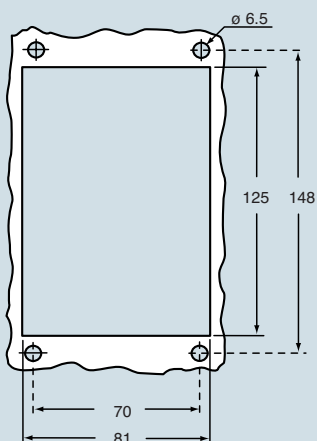

dimensions in mm

CHIW LS

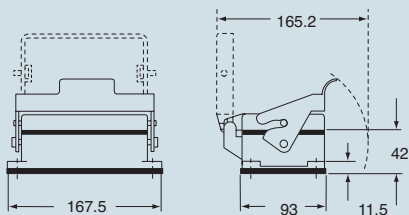

CHPW LS and MHPW LS

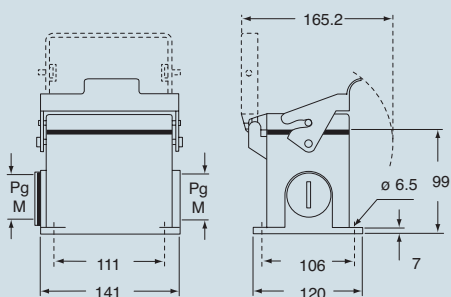

dimensions in mm

CHOW L and MHOW L

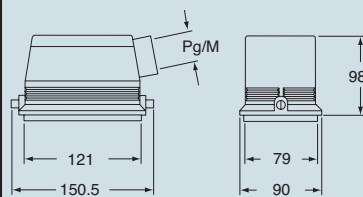

CHVW L and MHVW L

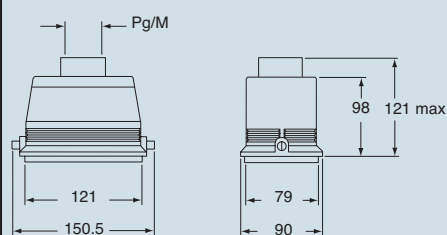

N.B.: the enclosures ensure IP66 protection (or IP65 cover versions) rating when mated and locked with the closing levers.
The cover (CS, CP) only ensures mechanical protection, but does not ensure IP65 protection rating.



dimensions indicated are not binding and may be changed without notice



enclosures:

- size "66.16" from page 166
- size "57.27" from page 184
- size "77.27" from page 198
- size "104.27" from page 212

inserts with screw fixing centre distance:

- 66 x 16 mm (enclosures CZAV/MZAV/MZVF 25...)
- 57 x 27 mm (enclosures CAV/MAV/MFV 10...)
- 77.5 x 27 mm (enclosures CAV/MAV/MFV 16... and CAF/MAF/MFF 16...)
- 104 x 27 mm (enclosures CAV/MAV/MFV 24... and CAF/MAF/MFF 24...)

hoods with double top entry



hoods with double front entry



description	part No.		entry Pg		part No.		entry M	
with pegs for 1 lever used with enclosures size "66.16"	CZAV 25 L216		16 x 2		MZAV 25 L220		20 x 2	
with pegs for 1 lever, without adaptor * used with enclosures size "66.16"	CZVF 25 L216		16 x 2		MZVF 25 L220		20 x 2	
with pegs for 2 lever - used with enclosures size "57.27" - used with enclosures size "77.27" - used with enclosures size "77.27" - used with enclosures size "104.27" - used with enclosures size "104.27"	CAV 10.213		13,5 x 2		MAV 10.220		20 x 2	
	CAV 16.216		16 x 2		MAV 16.220		20 x 2	
	CAV 16.221		21 x 2		MAV 16.225		25 x 2	
	CAV 24.221		21 x 2		MAV 24.232		32 x 2	
	CAV 24.229		29 x 2					
with pegs for 2 lever, without adaptor * - used with enclosures size "57.27" - used with enclosures size "77.27" - used with enclosures size "77.27" - used with enclosures size "104.27"	CFV 10.213		13,5 x 2		MFV 10.220		20 x 2	
	CFV 16.216		16 x 2		MFV 16.220		20 x 2	
	CFV 16.221		21 x 2		MFV 16.225		25 x 2	
	CFV 24.221		21 x 2		MFV 24.232		32 x 2	
with pegs for 2 lever - used with enclosures size "77.27" - used with enclosures size "104.27"	CAF 16.221		21 x 2		MAF 16.225		25 x 2	
	CAF 24.221		21 x 2		MAF 24.225		25 x 2	
with pegs for 2 lever, without adaptor * - used with enclosures size "77.27" - used with enclosures size "104.27"	CFF 16.221		21 x 2		MFF 16.225		25 x 2	
	CFF 24.221		21 x 2		MFF 24.225		25 x 2	

* enclosure without adaptor, threaded on the body, to be used only with a complete cable clamp.

dimensions in mm

CZAV/CZVF L2 and (MZAV/MZVF L2)

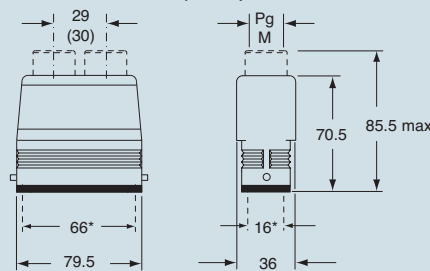

CAV/CFV and MAV/MFV

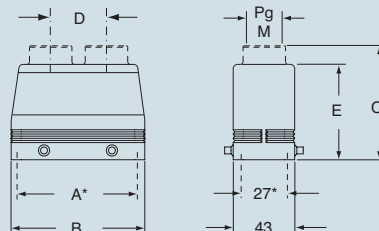

dimensions in mm

CAF/CFF and MAF/MFF

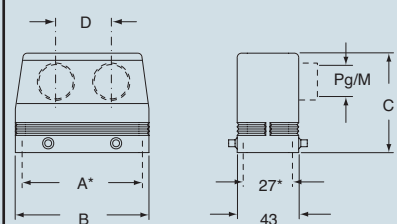

part No.	A*	B	C	D
CAF/CFF 16.221 / MAF/MFF 16.225	77.5	93.5	76	40
CAF/CFF 24.221 / MAF/MFF 24.225	104	120	76	50

*) screw fixing centre distance

CAV[®] US Type 4/4X/12

part No.	A*	B	C	D	E
CAV 10.213/MAV 10.220	57	73	82 (84.5)	26 (28.5)	70
CAV 16.216/MAV 16.220	77.5	93.5	89 (90.5)	35 (30)	76
CAV 16.221/MAV 16.225	77.5	93.5	90.5	40	76
CAV 24.221/MAV 24.232	104	120	90.5 (91)	50	76
CAV 24.229	104	120	90.5	50	76
CFV 10.213/MFV 10.220	57	73	--	28.5 (26)	70
CFV 16.216/MFV 16.220	77.5	93.5	--	30 (35)	76
CFV 16.221/MFV 16.225	77.5	93.5	--	40	76
CFV 24.221/MFV 24.232	104	120	--	50	76

*) screw fixing centre distance

dimensions indicated are not binding and may be changed without notice

enclosures:

- size "49.16".....from page 162
- size "66.16".....from page 166
- size "44.27".....from page 176
- size "57.27".....from page 184
- size "77.27".....from page 198
- size "104.27".....from page 212

inserts with screw fixing centre distance:

- 49 x 16 mm (enclosures CZAC 15 L)
- 66 x 16 mm (enclosures CZAC 25 L)
- 44 x 27 mm (enclosures CAC 06 L)
- 57 x 27 mm (enclosures CAC 10)
- 77.5 x 27 mm (enclosures CAC 16)
- 104 x 27 mm (enclosures CAC 24)
- 104 x 27 mm (enclosures CQO / MQO and CQV / MQV)

**enlarged hoods,
side or top entry**



**hoods
without entry, to be pierced**



description	part No.		part No.		part No.	part No.
		entry Pg		entry M	with 2 pegs	with 4 pegs
used with enclosures size "104.27" - with pegs for two levers, side entry - with pegs for two levers, top entry	CQO 24 CQV 24	36 36	MQO 24.40 MQV 24.40	40 40		
with pegs for levers - used with enclosures size "49.19" - used with enclosures size "66.16" - used with enclosures size "44.27" - used with enclosures size "57.27" - used with enclosures size "77.27" - used with enclosures size "104.27"					CZAC 15 L CZAC 25 L CAC 06 L CAC 10 L CAC 16 L CAC 24 L	CAC 10 CAC 16 CAC 24

dimensions in mm

CQO and MQO

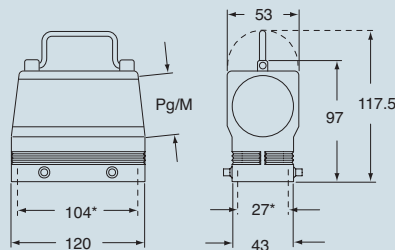

CQV and MQV

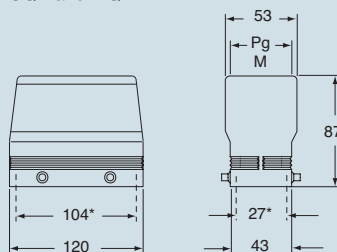

*) screw fixing centre distance

dimensions in mm

CZAC L

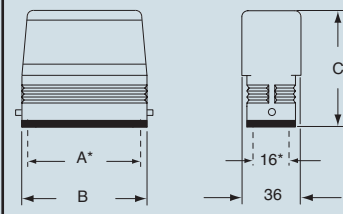

part No.	A*	B	C
CZAC 15 L	49.5	63	64.5
CZAC 25 L	66	79.5	70.5

*) screw fixing centre distance

CAC L

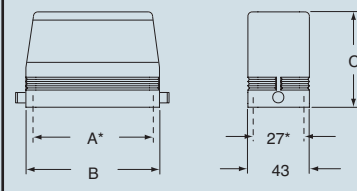

CAC

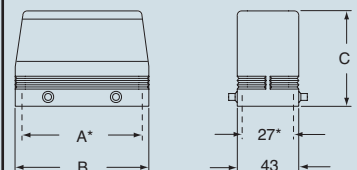

part No.	A*	B	C
CAC 06 L	44	60	72
CAC 10 - CAC 10 L	57	73	70
CAC 16 - CAC 16 L	77.5	93.5	76
CAC 24 - CAC 24 L	104	120	76

*) screw fixing centre distance

CALUS® Type 4/4X/12

(certification being applied for CQO and CQV 24, MQO and MQV 24.40)

dimensions indicated are not binding and may be changed without notice



inserts:		page
CD	64 poles + ⊕	45
CDD	108 poles + ⊕	58
CQE	46 poles + ⊕	77
CN	24 poles + ⊕	83
CCE	24 poles + ⊕	92
CNE, CSE.....	24 poles + ⊕	93
CSS	24 poles + ⊕	101
CMSE	10+2 (aux) poles + ⊕	118
CMCE	10+2 (aux) poles + ⊕	118
CX	4/8 poles + ⊕	133
MIXO	6 modules	137÷151

insert centre distance:
104 x 27 mm

hoods for ribbon cable
dual closure



NEW

seals
for ribbon cable hood



NEW

description	part No.	part No.
with levers, side entry	CAN 24	
ribbon cable seals (supplied separately) - a slot for cable sizes 18.8 x 5.8 mm - a slot for cable sizes 63.8 x 5.1 mm - a slot for cable sizes 36 x 9 mm - not pre-drilled		CRN 1 CRN 2 CRN 3 CRN P

dimensions in mm

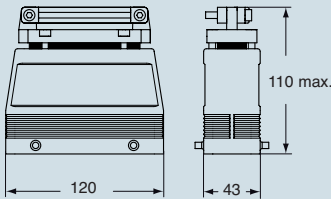

CAN

CEC® Type 4/4X/12
(certification being applied)

dimensions indicated are not binding
and may be changed without notice

inserts:	page
CME 10 + 2 (aux) poles + ⊕	119
CME, CMCE .. 16 + 2 (aux) poles + ⊕	124

insert centre distance:
104 x 27 mm

**hoods for ribbon cable
dual closure**



NEW

**seals
for ribbon cable hood**



NEW

description	part No.	part No.
with levers, side entry	CMAN 16	
ribbon cable seals (supplied separately) - a slot for cable sizes 18.8 x 5.8 mm - a slot for cable sizes 63.8 x 5.1 mm - a slot for cable sizes 36 x 9 mm - not pre-drilled		CRN 1 CRN 2 CRN 3 CRN P

dimensions in mm

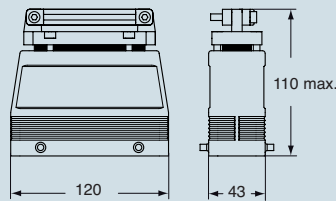

CEC® Type
US 4/4X/12
(certification being applied)

dimensions indicated are not binding
and may be changed without notice

cable passing hoods
degree of protection IP54



cable passing housings



description	part No.	part No.
-------------	----------	----------

with pegs for two levers
- 3 holes for round cables $\varnothing 5 \div 13.5$ mm
- 4 holes for round cables $\varnothing 5 \div 13.5$ mm

CYR 16.3
CYR 24.4

CHI 16
CHI 24

with two levers
- for hoods CYR 16.3
- for hoods CYR 24.4

CYR enclosures for round cables

The CYR enclosures are used in installations that require a passage for round cables for data transmission (e.g. computers or PLC) via equipment such as command or control panels, ensuring a good condition of the cable connections.

The enclosures are in two parts and have sealing gaskets to preserve the degree of protection of the equipment. The enclosures also contain a rapid cable block device.

The CYR 16.3 and 24.4 can be used with the bulkhead enclosures CHI 16 and CHI 24 respectively.

dimensions in mm

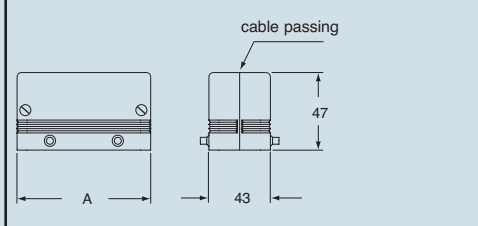

part No.	A	grommet entry	nr.
CYR 16.3	93.5	$\varnothing 5 / 13.5$	3
CYR 24.4	120	$\varnothing 5 / 13.5$	4

dimensions in mm

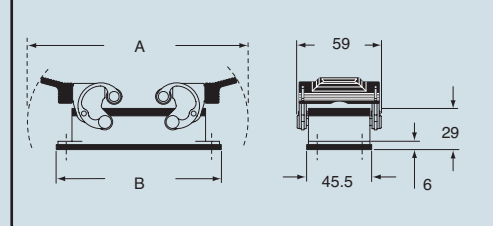

part No	A	B
CHI 16	153	115.5
CHI 24	179.5	142.5

CHI housings panel cut-out in mm

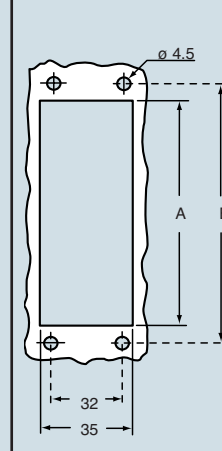

part No	A	B
CHI 16	86	103
CHI 24	112	130

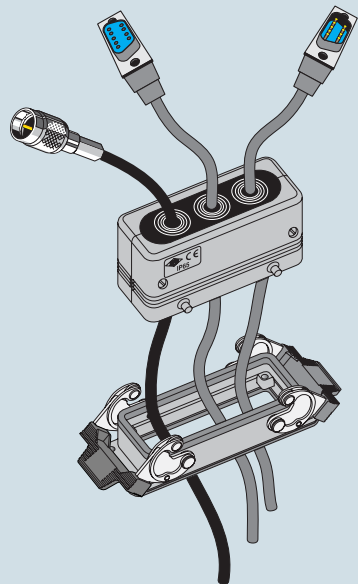

CALUS® Type 4/4X/12
(certification being applied for CYR 16.3 and CYR 24.4)

dimensions indicated are not binding and may be changed without notice

CYR

enclosures:
size "77.27"from page 198

inserts with screw fixing centre distance:
77.5 x 27 mm

N.B.: the enclosures ensure IP66 protection (or IP65 cover versions) rating when mated and locked with the closing levers.
The door only ensures mechanical protection, but does not ensure IP65 protection rating.

enclosures for in-line joints
degree of protection IP65



bulkhead housings
for in-line joint



description	part No.	part No.
without housings (to be ordered separately) made in two halves	CYG 16	
use with CYG for in-line joint - with one lever, without cover - with one lever and cover - with two levers - with pegs - with pegs and aluminium cover - with pegs and plastic cover		CHI 16 L CHI 16 LS CHI 16 CHI 16 C CHI 16 CS CHI 16 CP

CYG 16 in-line joint

- the joint is made with the CYG 16 enclosure and two bulkhead housings "size 77.27" with one or two levers (to be ordered separately).
- the joint is ideal for use with extension connections and/or as adaptor.
- made in two halves to facilitate conductor cabling.
- two inserts in various combinations may be inserted in the joint (to be ordered separately):

- » female/female inserts (as adaptor joint)
- » male/male inserts (as adaptor joint)
- » female/male inserts (as extension joint)

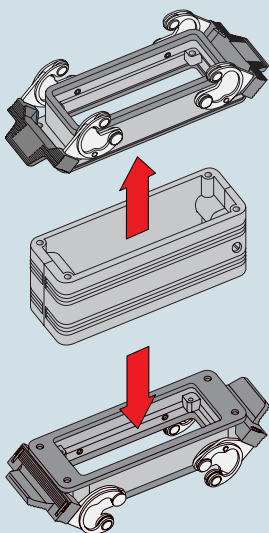

dimensions in mm

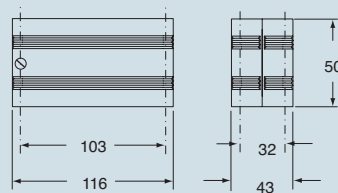

dimensions in mm

CHI 16 L

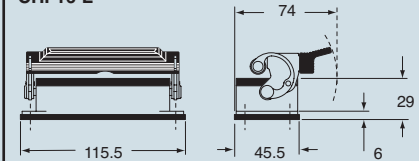

CHI 16 LS

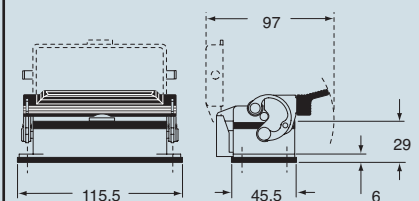

CHI 16

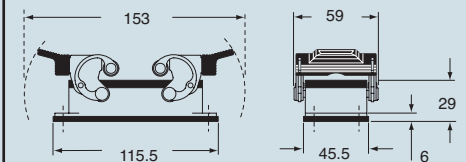

CHI C

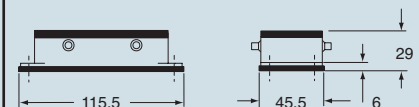

CHI 16 CS/CP

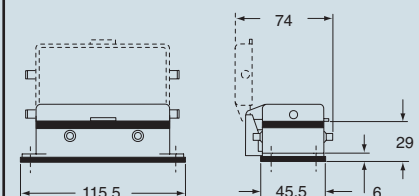

CALUS® Type 4/4X/12
(certification being applied for CYG 16)

dimensions indicated are not binding
and may be changed without notice

enclosures:

- size "44.27"from page 176
- size "57.27"from page 184
- size "77.27"from page 198
- size "104.27"from page 212

inserts with screw fixing centre distance:

- 44 x 27 mm (enclosures CHI and CAP/MAP 06...)
- 57 x 27 mm (enclosures CHI and CAP/MAP 10...)
- 77.5 x 27 mm (enclosures CHI and CAP/MAP 16...)
- 104 x 27 mm (enclosures CHI and CAP/MAP 24...)

bulkhead mounting housings for central lever



NEW

surface mounting housings, high construction with 2 entries for central lever



NEW

description	part No.	part No.	entry Pg	part No.	entry M
bulkhead mounting with pegs for central lever size "44.27" size "57.27" size "77.27" size "104.27"	CHI 06 YC CHI 10 YC CHI 16 YC CHI 24 YC				
surface mounting, high construction, with pegs, for central lever size "44.27" size "57.27" size "77.27" size "104.27"		CAP 06 YC229 CAP 10 YC229 CAP 16 YC229 CAP 24 YC229	29x2 29x2 29x2 29x2	MAP 06 YC232 MAP 10 YC232 MAP 16 YC232 MAP 24 YC232	32x2 32x2 32x2 32x2

panel cut-out bulkhead mounting housings in mm

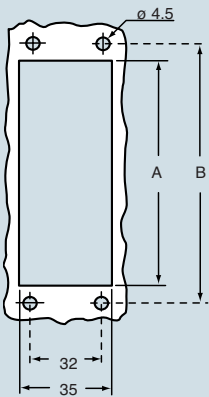

part No.	A	B
CHI 06 YC	52	70
CHI 10 YC	65	83
CHI 16 YC	86	103
CHI 24 YC	112	130

dimensions in mm

CHI YC

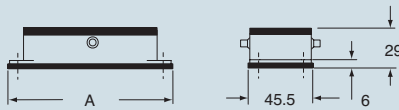

part No.	A
CHI 06 YC	82.5
CHI 10 YC	95.5
CHI 16 YC	115.5
CHI 24 YC	142.5

dimensions in mm

CAP YC and MAP YC

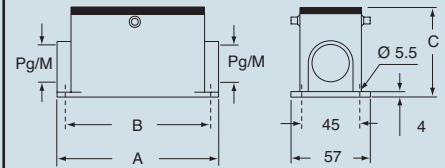

part No	A	B	C
CAP 06 YC / MAP 06 YC	82	70	74
CAP 10 YC / MAP 10 YC	93.5	82	74
CAP 16 YC / MAP 16 YC	117	105	81
CAP 24 YC / MAP 24 YC	144	132	81

special enclosures

CRUS® Type 4/4X/12

(certification being applied)

dimensions indicated are not binding and may be changed without notice

enclosures:

- size "44.27"from page 176
- size "57.27"from page 184
- size "77.27"from page 198
- size "104.27"from page 212

inserts with screw fixing centre distance:

- 44 x 27 mm (enclosures CAO/MAO and CAV/MAV 06...)
- 57 x 27 mm (enclosures CAO/MAO and CAV/MAV 10...)
- 77.5 x 27 mm (enclosures CAO/MAO and CAV/MAV 16...)
- 104 x 27 mm (enclosures CAO/MAO and CAV/MAV 24...)

hoods with central lever



NEW

hoods with central lever



NEW

description	part No.		part No.		part No.		part No.	
		entry Pg		entry M		entry Pg		entry M
side entry, high construction								
size "44.27"	CAO 06 YX21	21	MAO 06 YX25	25				
size "44.27"	CAO 06 YX29	29	MAO 06 YX32	32				
size "57.27"	CAO 10 YX21	21	MAO 10 YX32	32				
size "57.27"	CAO 10 YX29	29	MAO 10 YX40	40				
size "77.27"	CAO 16 YX21	21	MAO 16 YX32	32				
size "77.27"	CAO 16 YX29	29	MAO 16 YX40	40				
size "104.27"	CAO 24 YX21	21	MAO 24 YX32	32				
size "104.27"	CAO 24 YX29	29	MAO 24 YX40	40				
top entry, high construction								
size "44.27"					CAV 06 YX21	21	MAV 06 YX25	25
size "44.27"					CAV 06 YX29	29	MAV 06 YX32	32
size "57.27"					CAV 10 YX21	21	MAV 10 YX32	32
size "57.27"					CAV 10 YX29	29	MAV 10 YX40	40
size "77.27"					CAV 16 YX21	21	MAV 16 YX32	32
size "77.27"					CAV 16 YX29	29	MAV 16 YX40	40
size "104.27"					CAV 24 YX21	21	MAV 24 YX32	32
size "104.27"					CAV 24 YX29	29	MAV 24 YX40	40

dimensions in mm
CAO..YX and MAO..YX

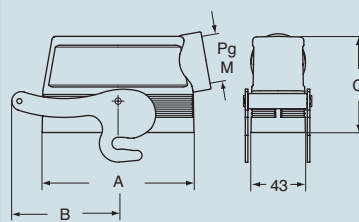

dimensions in mm
CAV..YX and MAV..YX

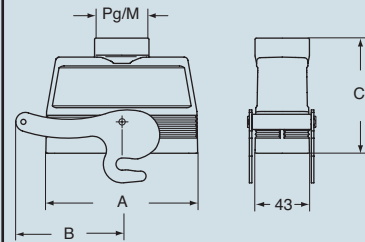

CAVUS® Type 4/4X/12

(certification being applied)

part No.	A	B	C
CAO 06 YX/MAO 06 YX	60	66	72
CAO 10 YX/MAO 10 YX	73	66	70
CAO 16 YX/MAO 16 YX	93.5	76	76
CAO 24 YX/MAO 24 YX	120	84	76

part No.	A	B	C
CAV 06 YX/MAV 06 YX	60	66	87 max
CAV 10 YX/MAV 10 YX	73	66	85
CAV 16 YX/MAV 16 YX	93.5	76	91
CAV 24 YX/MAV 24 YX	120	84	91

dimensions indicated are not binding and may be changed without notice

CG/MG series

The new CG/MG series of fixed and portable enclosures for connectors combines water tightness to IP68 rating and high mechanical sturdiness compliant with EMC standards.

The enclosures ensure the highest level of protection from external interferences; more specifically, they protect people from accessing the dangerous components housed inside the enclosures (direct contact) and they protect the internal connector inserts from the ingress of foreign matters (dust) and from the harmful effects of fluid ingress. The water tightness between the flush mounted enclosure and the panel is ensured by an O-ring seal held in position in a slot within the flush mounted enclosure base. A second O-ring seal fitted around the edges of the enclosure ensures the water tightness between the portable and the fixed enclosure when the connector is mated.

To ensure the water tightness when the enclosure is fitted onto a cabinet panel, the optional mounting frame with four M6 threaded blind holes may need to be installed inside the panel. The fastening screws must be fitted inside the enclosure and, through the fastening holes to be drilled on the panel, must be tightened onto the M6 mounting frame internal thread instead of the usual fastening nuts.

The flush mounted fixed enclosure fastening holes have been drilled inside the O-ring seal in order to avoid having to use other seals. Although these enclosures are larger than the standard enclosures to leave more space for the cables, and the walls are thicker to achieve more mechanical sturdiness, the fixing points have remained the same as those of the standard enclosures.

The series is offered with two types of locking systems: bayonet and screw. The two closing points are located in asymmetrical positions to ensure an optimal water tightness and the lowest footprint in case of multiple enclosures placed alongside at the front. The locking parts of both versions are made of high quality stainless steel and are firmly fastened inside the portable enclosure. These locking parts can be fitted and removed by using either a 1.5 mm flat blade screwdriver or a 10 mm hexagonal key.

The fixed and portable enclosures are made of foundry grade aluminium alloy, particularly resistant to sea water corrosion. The finish is made from epoxy polyester powder, which gives the enclosures high scratch and shock resistant properties.

The metal cover is made with the same quality materials as the enclosures, and is fitted with a short cord to make it always retrievable.

Scope of Application

External interconnections in vehicles, in harsh environments and in humid areas and with sensitive interconnections requiring screening.

They are particularly suitable for the applications in the railway industry and any application requiring high resistance to pressure, impact and corrosion, with IP68 protection rating. They also ensure a good screening for electromagnetic compatibility.

The IP68 protection rating printed on the enclosure is ensured if the enclosures are correctly installed and the cable entry devices have equal or higher rating.

Protection rating compliant with EN 60529 standard

When closed, the CG/MG enclosures protect the connector inserts fitted inside from outside interference, such as mechanical knocks, foreign bodies, humidity, dust, water or other fluids such as cleaning or cooling agents, oils etc.

The IP68 protection rating ensured by the enclosure is fully described in the EN 60529 standard, which classifies the enclosures according to their protection from the ingress of foreign bodies and water.

IP68 = total protection against dust, and from access to harmful parts with accessibility of Ø 1mm (First digit), and protection against the effects of prolonged submersion (>30') in water at the maximum depth of > 1 m (Second digit).

These enclosure have also successfully passed the tests required for the IPX6 protection rating compliant with EN 60529 standard and for the IPX9K protection rating compliant with DIN 40050-9 standard

The following table shows the different levels of protection required by the IP standard

1st Digit			2nd Digit		
IP	External solid objects	Protection	IP	Tests	Protection
0		none	0		none
1		against solid objects with Ø greater than 50 mm (for example contact with a hand)	1		against vertically falling drops of water
2		against solid objects with Ø greater than 12 mm (for example contact with a finger)	2		against vertically falling drops of water tilted at an angle of up to 15° from the vertical position
3		against solid objects with Ø greater than 2.5 mm (for example tools and wires)	3		against vertically falling drops of water tilted at an angle of up to 60° from the vertical position
4		against solid objects with Ø greater than 1 mm (for example thin tools and wires)	4		against water splashed from any direction
5		against dust (no harmful build-up)	5		against water jets from a nozzle from any direction
6		total protection against dust	6		against powerful water jets similar to sea waves
			7		against ingress of water when the enclosure is temporarily immersed in water at a maximum depth of 1 metre
			8		against the continuous submersion in water

special enclosures

- 1 Threaded cable entry hole, available in different Pg diameters (types with prefix starting with "C") or metric pitch (types with prefix starting with "M") compliant with EN 60423 standard, for cable entry devices compliant with EN 50262 standard, for vertical or horizontal layout.
- 2 Sturdy, corrosion proof foundry grade aluminium alloy enclosures, with chromate treated die cast. The following types are available: wall mounted, flush mounted fixed and portable enclosures with portable protective cover.
- 3 Oven painted with epoxy polyester powder in black RAL 9005, which gives the enclosures a high mechanical strength and makes them resistant to external agents.
- 4 The inserts are made of UL certified self-extinguishing fibreglass reinforced thermoplastics, and feature an operating temperature range between -40 °C and +125 °C.
- 5 Insert profile polarised with asymmetrical guides to avoid incorrect matings. The inserts have a mechanical life equal to or higher than 500 mating cycles.
- 6 Inserts are manufactured in compliance with European standard EN 61984 (DIN VDE 0627), certified and identified with UL and CSA markings.
- 7 Special NBR elastomere, anti-ageing, oil and fuel resistant seals which, together with the cable entry devices (not supplied) ensure mated connectors IP68 protection rating. The seals are internally positioned to give a better protection from sunlight and outside elements.

- 8 Fixings are available in two solutions: with hexagonal head stainless steel screws or bayonet type. The slotted hexagonal head screws can be fitted and removed by using either a 1.5mm thick blade screwdriver or a 10mm hexagonal key, and can be easily accessed even when fitted on enclosures with horizontally exited cables. Tightening torque 2.5 Nm.
- 9 Captive insert fastening screws, with anti-slackening spring washer.
- 10 Contact position identified with numbers or codes on both sides of each insert and printed with a laser system or from a die.
- 11 Silver or gold plated brass contacts connected to the wires by means of captive screws supplied already slackened, with spring terminal, by means of crimping (contacts available separately), or with a built-in 45° terminal block (still with screw or spring terminal).

- 12 Protective earth terminal with a wide contact surface.
- 13 CE marking which certifies compliance with the 73/23/EEC Low Voltage Directive and its 93/68/EEC amendment.
- 14 Fixed, flush mounted enclosure with fastening screws inside the seal.
- 15 Wider enclosures to give more space for the cabling.
- 16 They ensure a good screening for electromagnetic compatibility, resistance to vibrations in compliance with EN 61373 standard and to pressurised water.

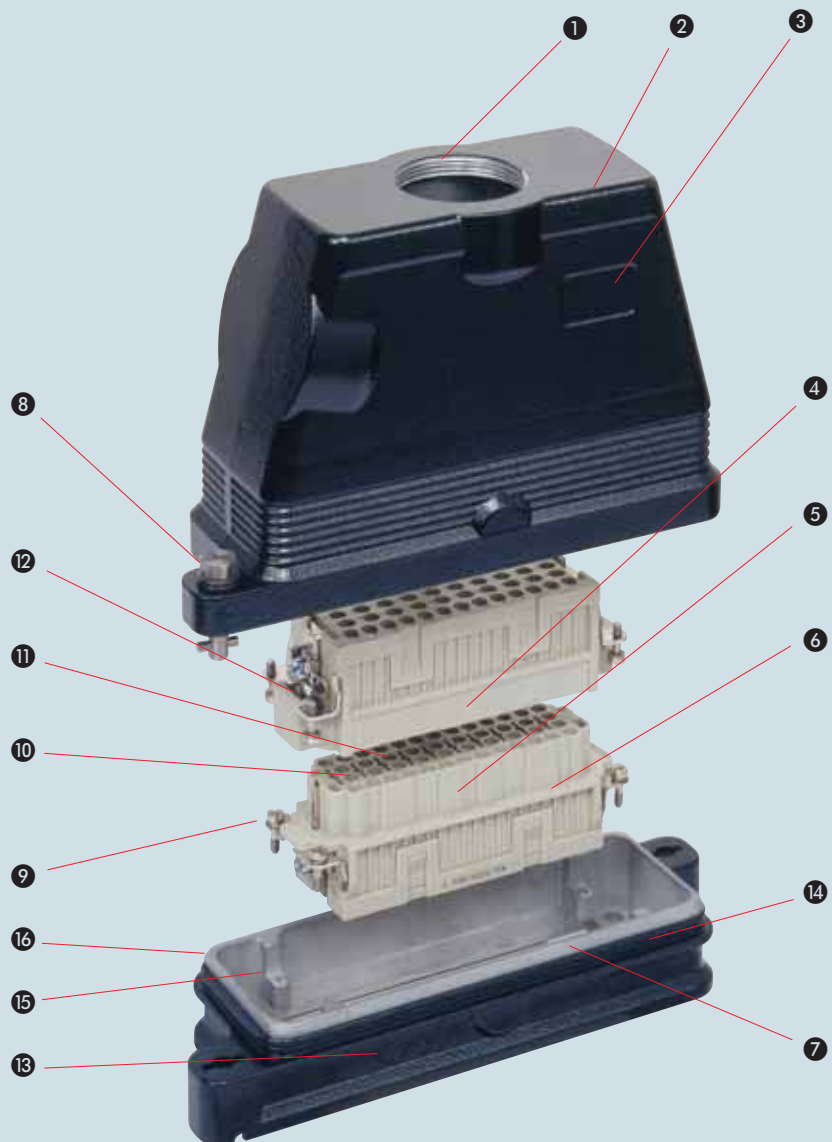



enclosures:
size "21.21" page 247

inserts with screw fixing centre distance:
21 x 21 mm

bulkhead mounting housing



angled bulkhead mounting housings



description	part No.	part No.		part No.	
		entry Pg	entry M	entry M	entry M
bulkhead mounting housing	CGK I				
without cable gland outlet		CGK IA	--		
with threaded entry		CGK IAP13	13,5	MGK IAP20	20

ON RESEARCH

ON RESEARCH

dimensions indicated are not binding
and may be changed without notice

special enclosures



enclosures:
 size "21.21" page 246

inserts with screw fixing centre distance:
 21 x 21 mm

hoods



description	part No.	entry Pg	part No.	entry M
top entry	CGK V13	13,5	MGK V20	20

ON RESEARCH

dimensions indicated are not binding
 and may be changed without notice



enclosures and covers:

- size "44.27"page 249
- size "57.27"page 249
- size "77.27"page 249
- size "104.27"page 249

inserts with screw fixing centre distance:

- 44 x 27 mm (enclosures CGI and CGP/MGP 06)
- 57 x 27 mm (enclosures CGI and CGP/MGP 10)
- 77 x 27 mm (enclosures CGI and CGP/MGP 16)
- 104 x 27 mm (enclosures CGI and CGP/MGP 24)

bulkhead mounting housing

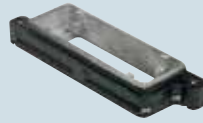

surface mounting housing



description	part No.	part No.		part No.	
		entry Pg	entry M	entry Pg	entry M
size "44.27"	CGI 06				
size "57.27"	CGI 10				
size "77.27"	CGI 16				
size "104.27"	CGI 24				
size "44.27"		CGP 06.29	29	MGP 06.32	32
size "57.27"		CGP 10.29	29	MGP 10.32	32
size "77.27"		CGP 16.36	36	MGP 16.40	40
size "104.27"		CGP 24.36	36	MGP 24.40	40
size "104.27"		CGP 24.236	36 x 2	MGP 24.240	40 x 2

panel cut-out for bulkhead mounting housings in mm

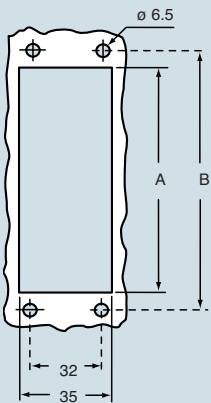

part No.	A	B
CGI 06	52	70
CGI 10	65	83
CGI 16	86	103
CGI 24	112	130

dimensions in mm

CGI

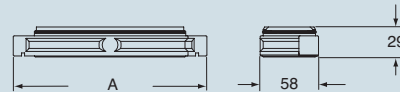

part No.	A
CGI 06	133
CGI 10	146
CGI 16	166
CGI 24	193

dimensions in mm

CGP and MGP

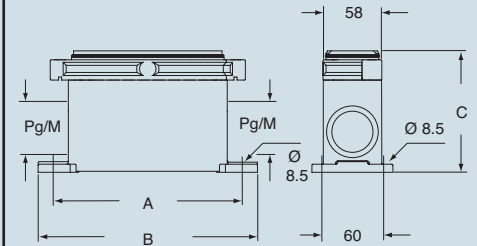

part No.	A	B	C
CGP 06 - MGP 06	127	156	110
CGP 10 - MGP 10	140	169	110
CGP 16 - MGP 16	160	189	121
CGP 24 - MGP 24	187	216	121

special enclosures



dimensions indicated are not binding and may be changed without notice



enclosures:

- size "44.27"page 248
- size "57.27"page 248
- size "77.27"page 248
- size "104.27"page 248

inserts with screw fixing centre distance:

- 44 x 27 mm (enclosures CGO/MGO and CGV/MGV 06)
- 57 x 27 mm (enclosures CGO/MGO and CGV/MGV 10)
- 77 x 27 mm (enclosures CGO/MGO and CGV/MGV 16)
- 104 x 27 mm (enclosures CGO/MGO and CGV/MGV 24)

hoods



covers



description	part No.		part No.		part No.
		entry Pg		entry M	
side entry					
size "44.27"	CGO 06.16	16	MGO 06.25	25	
size "44.27"	CGO 06.21	21	MGO 06.32	32	
size "44.27"	CGO 06.29	29			
size "57.27"	CGO 10.16	16	MGO 10.25	25	
size "57.27"	CGO 10.21	21	MGO 10.32	32	
size "57.27"	CGO 10.29	29			
size "77.27"	CGO 16.21	21	MGO 16.32	32	
size "77.27"	CGO 16.29	29	MGO 16.40	40	
size "77.27"	CGO 16.36	36	MGO 16.50	50	
size "104.27"	CGO 24.21	21	MGO 24.32	32	
size "104.27"	CGO 24.29	29	MGO 24.40	40	
size "104.27"	CGO 24.36	36	MGO 24.50	50	
top entry					
size "44.27"	CGV 06.16	16	MGV 06.25	25	
size "44.27"	CGV 06.21	21	MGV 06.32	32	
size "44.27"	CGV 06.29	29	MGV 06.40	40	
size "57.27"	CGV 10.16	16	MGV 10.25	25	
size "57.27"	CGV 10.21	21	MGV 10.32	32	
size "57.27"	CGV 10.29	29	MGV 10.40	40	
size "77.27"			MGV 16.25	25	
size "77.27"			MGV 16.225	25x2	
size "77.27"	CGV 16.21	21	MGV 16.32	32	
size "77.27"	CGV 16.221	21x2			
size "77.27"	CGV 16.29	29	MGV 16.40	40	
size "77.27"	CGV 16.36	36	MGV 16.50	50	
size "104.27"			MGV 24.325	25x3	
size "104.27"	CGV 24.21	21	MGV 24.32	32	
size "104.27"			MGV 24.232	32x2	
size "104.27"	CGV 24.29	29	MGV 24.40	40	
size "104.27"	CGV 24.229	29x2	MGV 24.240	40x2	
size "104.27"	CGV 24.36	36	MGV 24.50	50	
size "44.27"					CGC 06
size "57.27"					CGC 10
size "77.27"					CGC 16
size "104.27"					CGC 24

special enclosures



dimensions in mm

CGO/MGO and CGV/MGV

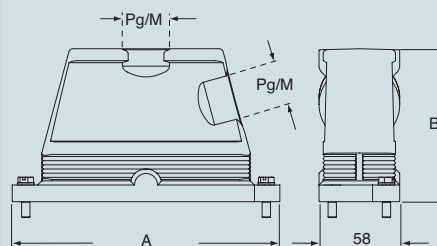

part No.	A	B
CGO/MGO and CGV/MGV 06	133	101
CGO/MGO and CGV/MGV 10	146	101
CGO/MGO and CGV/MGV 16	166	111
CGO/MGO and CGV/MGV 24	193	111

dimensions in mm

CGC

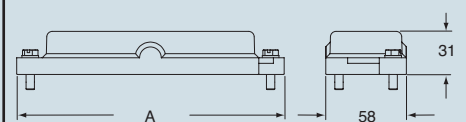

part No.	A
CGC 06	133
CGC 10	146
CGC 16	166
CGC 24	193

dimensions indicated are not binding and may be changed without notice

enclosures and covers:

- size "44.27"page 251
- size "57.27"page 251
- size "77.27"page 251
- size "104.27"page 251

inserts with screw fixing centre distance:

- 44 x 27 mm** (enclosures CGI 06 B)
- 57 x 27 mm** (enclosures CGI 10 B)
- 77 x 27 mm** (enclosures CGI 16 B)
- 104 x 27 mm** (enclosures CGI 24 B)

bulkhead mounting housings



description	part No.
size "44.27"	CGI 06 B
size "57.27"	CGI 10 B
size "77.27"	CGI 16 B
size "104.27"	CGI 24 B

panel cut-out for bulkhead mounting housings in mm

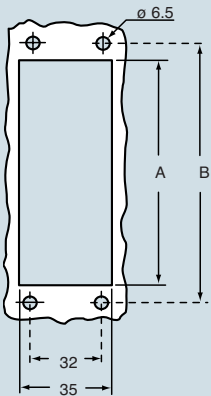

part No.	A	B
CGI 06 B	52	70
CGI 10 B	65	83
CGI 16 B	86	103
CGI 24 B	112	130

dimensions in mm

CGI..B

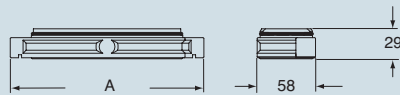

part No.	A
CGI 06 B	133
CGI 10 B	146
CGI 16 B	166
CGI 24 B	193

special enclosures



dimensions indicated are not binding and may be changed without notice



enclosures:

- size "44.27"page 250
- size "57.27"page 250
- size "77.27"page 250
- size "104.27"page 250

inserts with screw fixing centre distance:

- 44 x 27 mm (enclosures CGO/MGO and CGV/MGV 06 B)
- 57 x 27 mm (enclosures CGO/MGO and CGV/MGV 10 B)
- 77 x 27 mm (enclosures CGO/MGO and CGV/MGV 16 B)
- 104 x 27 mm (enclosures CGO/MGO and CGV/MGV 24 B)

hoods



covers



description	part No.		part No.		part No.
		entry Pg		entry M	
side entry					
size "44.27"	CGO 06.16 B	16	MGO 06.25 B	25	
size "44.27"	CGO 06.21 B	21	MGO 06.32 B	32	
size "44.27"	CGO 06.29 B	29			
size "57.27"	CGO 10.16 B	16	MGO 10.25 B	25	
size "57.27"	CGO 10.21 B	21	MGO 10.32 B	32	
size "57.27"	CGO 10.29 B	29			
size "77.27"	CGO 16.21 B	21	MGO 16.32 B	32	
size "77.27"	CGO 16.29 B	29	MGO 16.40 B	40	
size "77.27"	CGO 16.36 B	36	MGO 16.50 B	50	
size "104.27"	CGO 24.21 B	21	MGO 24.32 B	32	
size "104.27"	CGO 24.29 B	29	MGO 24.40 B	40	
size "104.27"	CGO 24.36 B	36	MGO 24.50 B	50	
top entry					
size "44.27"	CGV 06.16 B	16	MGV 06.25 B	25	
size "44.27"	CGV 06.21 B	21	MGV 06.32 B	32	
size "44.27"	CGV 06.29 B	29	MGV 06.40 B	40	
size "57.27"	CGV 10.16 B	16	MGV 10.25 B	25	
size "57.27"	CGV 10.21 B	21	MGV 10.32 B	32	
size "57.27"	CGV 10.29 B	29	MGV 10.40 B	40	
size "77.27"			MGV 16.25 B	25	
size "77.27"			MGV 16.225 B	25x2	
size "77.27"	CGV 16.21 B	21	MGV 16.32 B	32	
size "77.27"	CGV 16.221 B	21x2			
size "77.27"	CGV 16.29 B	29	MGV 16.40 B	40	
size "77.27"	CGV 16.36 B	36	MGV 16.50 B	50	
size "104.27"			MGV 24.325 B	25x3	
size "104.27"	CGV 24.21 B	21	MGV 24.32 B	32	
size "104.27"			MGV 24.232 B	32x2	
size "104.27"	CGV 24.29 B	29	MGV 24.40 B	40	
size "104.27"	CGV 24.229 B	29x2	MGV 24.240 B	40x2	
size "104.27"	CGV 24.36 B	36	MGV 24.50 B	50	
size "44.27"					CGC 06 B
size "57.27"					CGC 10 B
size "77.27"					CGC 16 B
size "104.27"					CGC 24 B

special enclosures

dimensions in mm

CGO/MGO..B and CGV/MGV..B

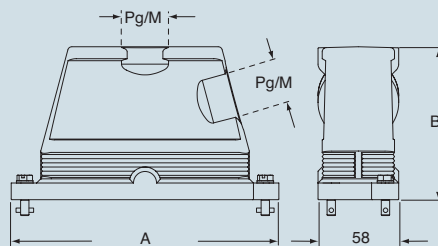

part No.	A	B
CGO/MGO and CGV/MGV 06 B	133	101
CGO/MGO and CGV/MGV 10 B	146	101
CGO/MGO and CGV/MGV 16 B	166	111
CGO/MGO and CGV/MGV 24 B	193	111

dimensions in mm

CGC..B

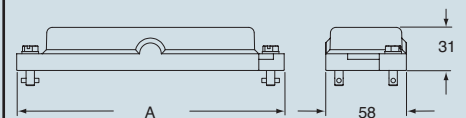

part No.	A
CGC 06 B	133
CGC 10 B	146
CGC 16 B	166
CGC 24 B	193



dimensions indicated are not binding and may be changed without notice



bulkhead mounting housings:

- size "44.27"page 248-250
- size "57.27"page 248-250
- size "77.27"page 248-250
- size "104.27"page 248-250

frames for bulkhead mounting housings

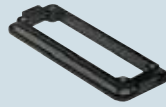

description	part No.
size "44.27"	CG 06 FL
size "57.27"	CG 10 FL
size "77.27"	CG 16 FL
size "104.27"	CG 24 FL

dimensions in mm

CG..FL

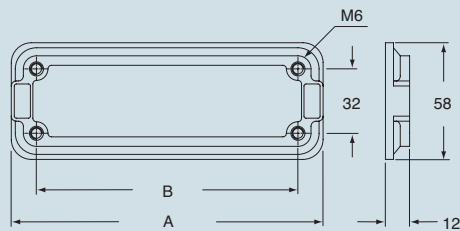

part No.	A	B
CG 06 FL	96	70
CG 10 FL	109	83
CG 16 FL	129	103
CG 24 FL	156	130

special enclosures

CRUS® Type 4/4X/12

dimensions indicated are not binding and may be changed without notice



enclosures:

size "44.27"from page 176

size "57.27"from page 184

inserts with screw fixing centre distance:

44 x 27 mm

57 x 27 mm

1 branch-off T-BOX coupling



NEW

1 branch-off T-BOX coupling
be fitted on DIN rails



NEW

description	part No.	part No.
for 2 C portable enclosures with lever and seal "44.27" size and one CHI enclosure "44.27" A size	CYG 06H06	
for 2 C portable enclosures with lever and seal "44.27" size and one CHI enclosure "57.27" A size	CYG 06H10	
for 2 C portable enclosures with lever and seal "44.27" size and one CHI enclosure "44.27" A size		CYG 06H06D
for 2 C portable enclosures with lever and seal "44.27" size and one CHI enclosure "57.27" A size		CYG 06H10D

How to use the CYG 06H branch coupling

The cables are branched off by using the CYG 06H coupling in the 1 or 2 branch-off versions. Multi-pole inserts "44.27" size can be fitted inside the two side recesses.

The entire unit can be used with one lever flying enclosures complete with connector inserts.

The front faces can be fitted with "44.27" and/or "57.27" size flush mounted enclosures.

The coupling may also be used as an adapter by using a combination of different insert versions.

The CHC 06 LG cover may be used to close the coupling side faces.

In the branch-offs, the CSS series dual spring terminal inserts allow two wires to be connected without having to fit additional terminals inside the coupling.

dimensions in mm

CYG...H06 / H10

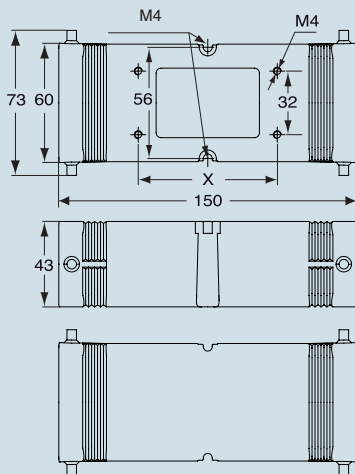

part No.	X
CYG 06H06	70
CYG 06H10	83

dimensions in mm

CYG...H06D / H10D

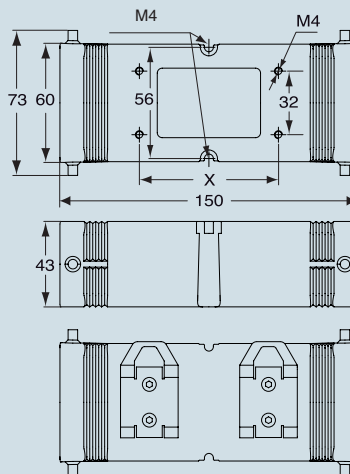

part No.	X
CYG 06H06D	70
CYG 06H10D	83

part No.	A	C
	CHI	CHV .. LG *
CYG 06H06	06	06
CYG 06H10	10	06
CYG 06H06D	06	06
CYG 06H10D	10	06

* the following enclosures may also be used:
MHV / CAV / MAV / CFV / MFV 06 LG

CALUS® Type 4/4X/12

(certification being applied)

dimensions indicated are not binding and may be changed without notice

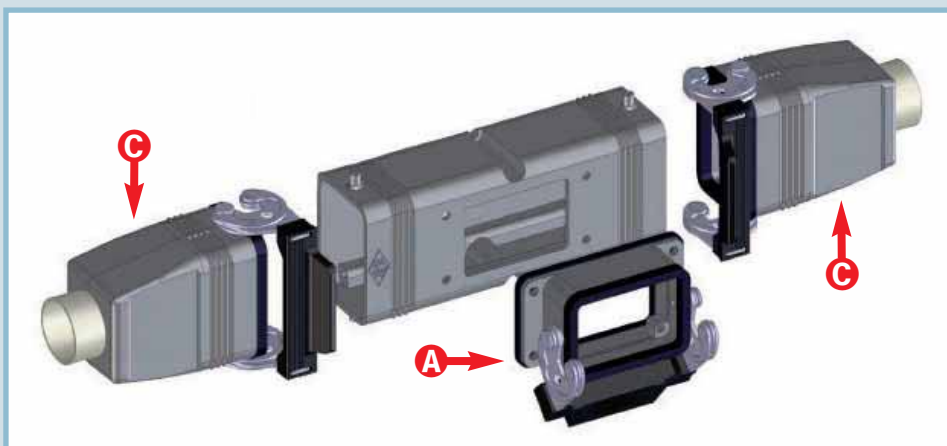

enclosures:

size "44.27"from page 176
 size "57.27"from page 184

inserts with screw fixing centre distance:
 44 x 27 mm
 57 x 27 mm

2 branch-off T-BOX coupling



NEW

2 branch-off T-BOX coupling



NEW

description	part No.	part No.
for 2 "44.27" size portable enclosures with lever and seal and 1 "44.27" size fixing side CHI enclosure and one "57.27" size CHI enclosure	CYG 06H0610	
for 2 "44.27" size portable enclosures with lever and seal and 1 "57.27" size fixing side CHI enclosure and one "44.27" size CHI enclosure	CYG 06H1006	
for 2 "44.27" size portable enclosures with lever and seal and two "44.27" size CHI enclosures		CYG 06H0606
for 2 "44.27" size portable enclosures with lever and seal and two "57.27" size CHI enclosures		CYG 06H1010

How to use the CYG 06H branch coupling

The cables are branched off by using the CYG 06H coupling in the 1 or 2 branch-off versions. Multi-pole inserts "44.27" size can be fitted inside the two side recesses. The entire unit can be used with one lever flying enclosures complete with connector inserts. The front faces can be fitted with "44.27" and/or "57.27" size flush mounted enclosures. The coupling may also be used as an adapter by using a combination of different insert versions. The CHC 06 LG cover may be used to close the coupling side faces. In the branch-offs, the CSS series dual spring terminal inserts allow two wires to be connected without having to fit additional terminals inside the coupling.

dimensions in mm

CYG...H0610 / H1006 and CYG...H0606 / H1010

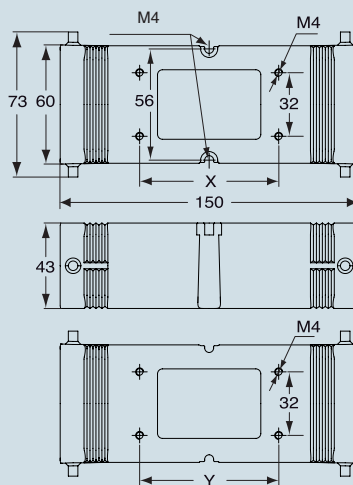

part No.	X	Y
CYG 06H0610	83	70
CYG 06H1006	70	83
CYG 06H0606	70	70
CYG 06H1010	83	83

part No.	A	B	C
	CHI	CHI	CHV .. LG *
CYG 06H0610	06	10	06
CYG 06H1006	10	06	06
CYG 06H0606	06	06	06
CYG 06H1010	10	10	06

* the following enclosures may also be used:
 MHV / CAV / MAV / CFV / MFV 06 LG

CALUS® Type 4/4X/12
 (certification being applied)

dimensions indicated are not binding and may be changed without notice

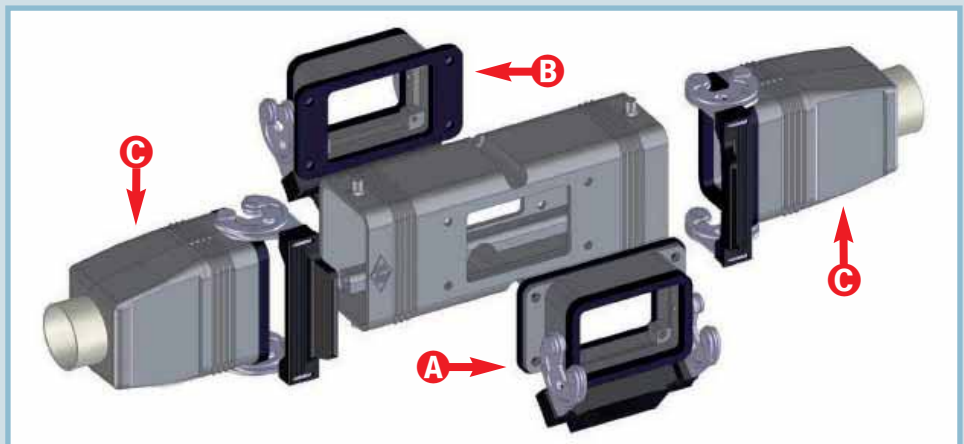

COB TCQ + COB TSFS
(COB...CMS, alternative)

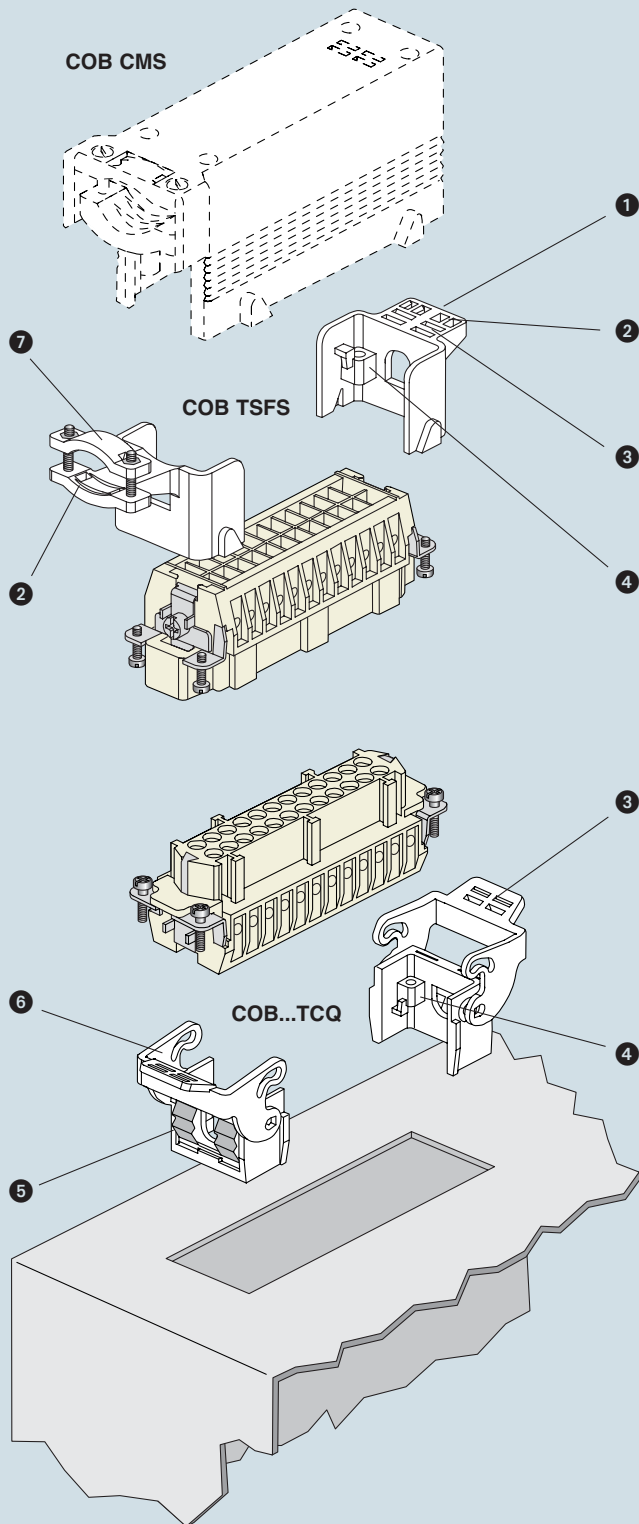

Figure 1:
- snap fastening in window*, panels or control panels

Use

The COB system makes it possible to use multipole connectors within electric panels without the traditional metallic housing as protection is assured by the electric panel itself or other container.

N.B.: The containers must not be handled live.

The COB system may be assembled in the three following ways:

- on panels with window snap fastening device* (**Figure 1**)
- on DIN EN 60715 rails, both lengthways and crossways to the support (**Figure 2**)
- on fixed panels using screws (**Figure 2**)

The COB system offers the following advantages:

- reduction in cost and space with respect to metallic enclosures and traditional terminal boards
- possibility of rewiring at the connector bench with connected devices
- easy wiring inspection and tests with coupled connectors, thanks to rear access to the inserts via the turnover device
- fast mounting within the panels thanks to the snap fastening device on the DIN EN 60715 rails
- sturdy support structure, specific to the size of each insert and does not require any preparation
- broad passage for housing of conductor cables
- mobile parts prearranged for the clamping of bundles of conductors of multipolar cables to prevent contact with the connector contacts

The COB system satisfies the most various installation needs thanks to the interchangeability of the connector inserts. The inserts can be installed as per the following table:

supports for connector inserts

bulkhead	COB TCQ			
	COB 06 BC	COB 10 BC	COB 16 BC	COB 24 BC
mobile	COB TSF and COB TSFS			
	COB 06 CMS	COB 10 CMS	COB 16 CMS	COB 24 CMS

insert centre distance

mm	44 x 27	57 x 27	49.5 x 16* 66 x 16* 77.5 x 27	104 x 27

insert series and polarity + ⊕

Series	44 x 27	57 x 27	49.5 x 16* 66 x 16* 77.5 x 27	104 x 27
CD			15*, 25*, 40	64
CDD	24	42	38*, 72	108
CDA			10*, 16*	
CDC			10*, 16*	
CC	6	10	16	24
CCE	6	10	16	24
CQE	10	18	32	46
CN	6	10	16	24
CNE	6	10	16	24
CS	6	10	16	24
CSE	6	10	16	24
CMCE		3 + 2	6 + 2	10 + 2 16 + 2
CME		3 + 2	6 + 2	10 + 2 16 + 2
CMS		3 + 2	6 + 2	10 + 2
CP			6	
CX			4/0, 4/2 6/36 12/2	4/8
MIXO	2 modules	3 modules	4 modules	6 modules

*) mounting via adaptor plates described on page 260

In addition, the COB..BC supports may house the ILME CR...AD1 and CR...AD2 series plates for the D-SUB inserts (microconnectors).

Characteristics

- 1 COB, TSF or COB TSFS insert support blocks (with cable clamp) for mobile mounting, in self-extinguishing thermoplastic material.
- 2 passage for cable support bands (from 2.2 to 4.8 mm).
- 3 slots for identification cards (dimensions 9 x 20 mm).
- 4 threaded metallic inserts for fixing the inserts with normal screws and possibility of coded connection with the use of specific coded pins (ILME article: CR 20, CRM, CRF, CR 20 CX, CRM CX and CRF CX) when identical connectors are used.
- 5 COB TCQ insert carrier block for window* mounting in self-extinguishing thermoplastic material, with spring snap fastening.
- 6 locking device with levers in self-extinguishing thermoplastic material for insert coupling.
- 7 sturdy cable clamp for clamping multipolar cables with a diameter of up to 25 mm or bundles of unipolar conductors.
- 8 COB...CMS housing for mobile mounting, in self-extinguishing thermoplastic material, IP20 degree of protection.
- 9 free passage for mounting of wired insert with conductor cables.
- 10 Mobile blocks (in COB...BC kit) in self-extinguishing thermoplastic material, with quick release device for insert turnover, wiring operations, verifications and maintenance.
- 11 COB...BC panel support for bulkhead mounting in self-extinguishing thermoplastic material, sturdy block support structure, with broad passage for housing of conductor cables.
- 12 holes for fixed fastening with screws without DIN EN 60715 rails.
- 13 snap fastening on DIN EN 60715 rails both lengthways and crossways to the support.
- 14 turnover pins that can be released and allow the use of prewired inserts.

COB...BC + COB...CMS (COB TSF, alternative)

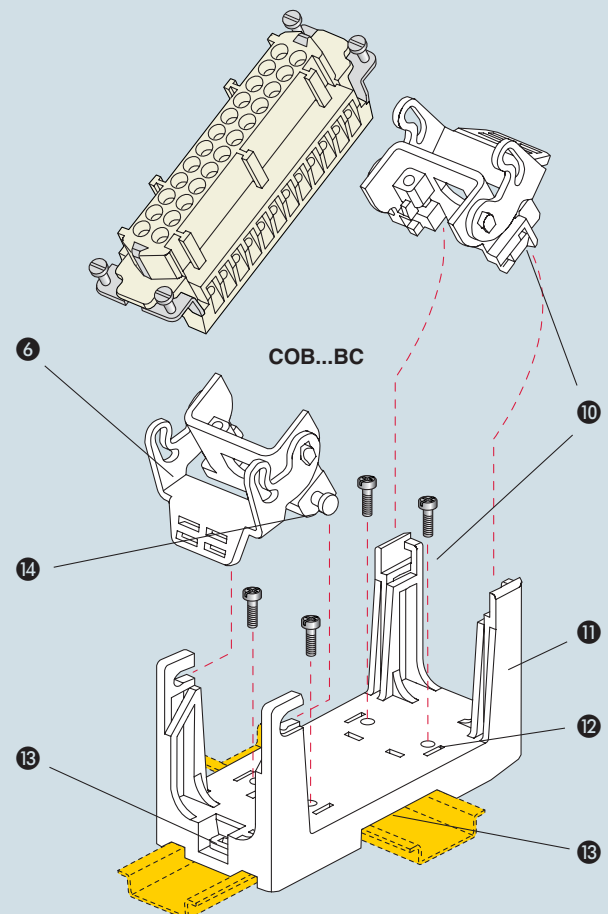
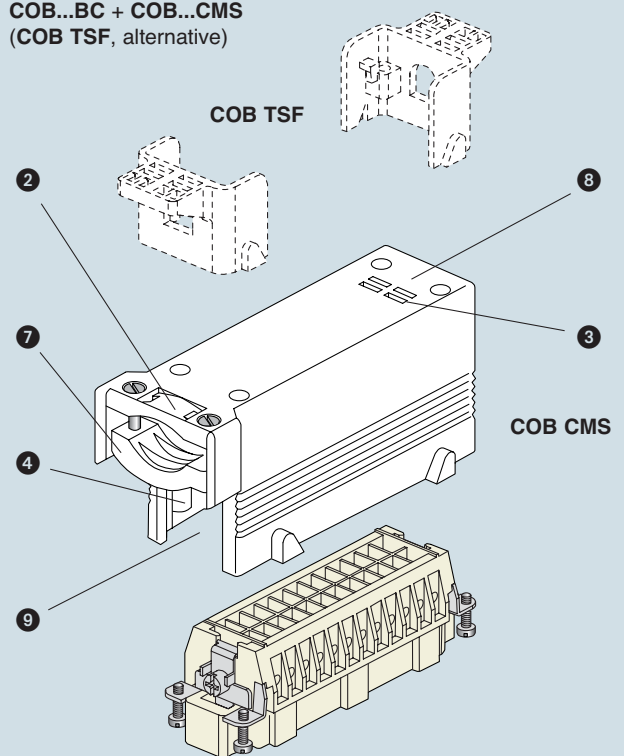

Figure 2:

- snap fastening on DIN EN 60715 rails both lengthways and crossways to the support
- installation in panels or control panels, with fixed fastening with screws

inserts:	page
CD40, 64 poles + ⊕	43-45
CDD 24, 42, 72, 108 poles + ⊕	53-58
CQE 10, 18, 32, 46 poles + ⊕	74-77
CN 6, 10, 16, 24 poles + ⊕	80-83
CCE 6, 10, 16, 24 poles + ⊕	86-92
CNE, CSE.. 6, 10, 16, 24 poles + ⊕	87-93
CSS 6, 10, 16, 24 poles + ⊕	98-101
CMSE 3+ ² , 6+ ² , 10+ ² poles + ⊕	114-118
CMCE 3+ ² , 6+ ² , 10+ ² , 16+ ² poles + ⊕	114-124
CME .. 3+ ² , 6+ ² , 10+ ² , 16+ ² poles + ⊕	115-124
CP 6 poles + ⊕	127
CX 8/24, 6/36, 12/2 poles + ⊕	129-131
CX 4/0, 4/2, 4/8 poles + ⊕	132-133
MIXO..... 2, 3, 4, 6 modules	137-151

insert centre distance:
44 x 27 mm, 57 x 27 mm,
77.5 x 27 mm, 104 x 27 mm

connector carrier for faceplate mounting in window*, snap fastening



connector carrier baseplate for mounting on DIN EN 60715 rail or fixed mounting using screws



description	part No.	part No.
-------------	----------	----------

kit with 2 elements, for coupling of inserts with fastening centre distance (short side = 27 mm)

COB TCQ

kit comprising frame and mobile blocks, for insert coupling:

- with screw fixing centre distance of 44 x 27 mm
- with screw fixing centre distance of 57 x 27 mm
- with screw fixing centre distance of 77.5 x 27 mm
- with screw fixing centre distance of 104 x 27 mm

COB 06 BC
COB 10 BC
COB 16 BC
COB 24 BC

panel cut-out in mm

dimensions in mm

dimensions in mm

COB TCQ

window size on plate thickness 1.3-3 mm

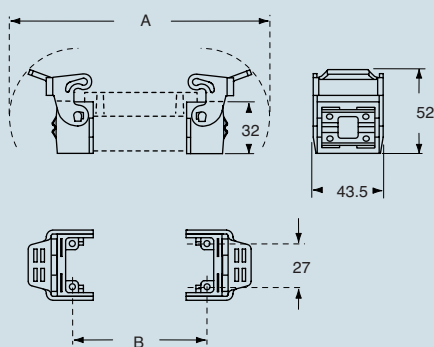
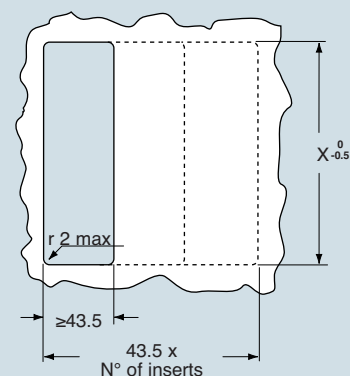

overall dimensions with transversal DIN rails

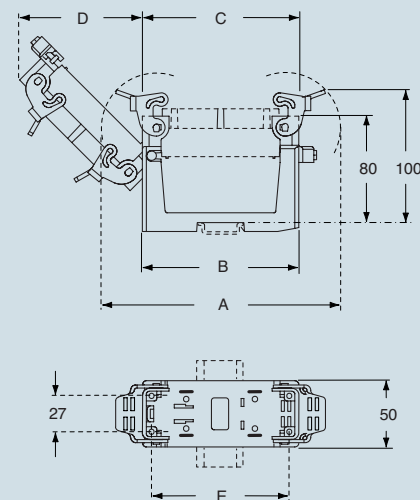

for coupling with inserts type	X°
with centre distance 44 x 27 mm	65
with centre distance 57 x 27 mm	78
with centre distance 77.5 x 27 mm	98
with centre distance 104 x 27 mm	125

COB TCQ

for inserts	A	B
with centre distance 44 x 27 mm	120	44
with centre distance 57 x 27 mm	133	57
with centre distance 77.5 x 27 mm	153.5	77.5
with centre distance 104 x 27 mm	180	104

part No.	A	B	C	D	E
COB 06 BC	120	91.5	58	50	44
COB 10 BC	133	91.5	71	59.5	57
COB 16 BC	153.5	91.5	91.5	74	77.5
COB 24 BC	180	118	118	93	104

COB...BC

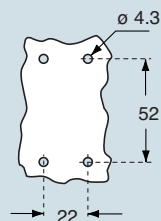

dimensions indicated are not binding and may be changed without notice

overall dimensions without DIN rails (values with "asterisk")
 overall dimensions with longitudinal DIN rails

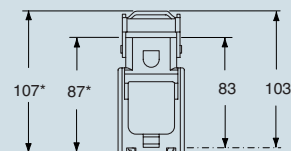

inserts:	page
CD40, 64 poles + ⊕	43-45
CDD 24, 42, 72, 108 poles + ⊕	53÷58
CQE 10, 18, 32, 46 poles + ⊕	74÷77
CN 6, 10, 16, 24 poles + ⊕	80÷83
CCE 6, 10, 16, 24 poles + ⊕	86÷92
CNE, CSE .. 6, 10, 16, 24 poles + ⊕	87÷93
CSS 6, 10, 16, 24 poles + ⊕	98÷101
CMSE 3+ ² , 6+ ² , 10+ ² poles + ⊕	114÷118
CMCE 3+ ² , 6+ ² , 10+ ² , 16+ ² poles + ⊕	114÷124
CME .. 3+ ² , 6+ ² , 10+ ² , 16+ ² poles + ⊕	115÷124
CP 6 poles + ⊕	127
CX 8/24, 6/36, 12/2 poles + ⊕	129÷131
CX 4/0, 4/2, 4/8 poles + ⊕	132÷133
MIXO 2, 3, 4, 6 modules	137÷151

insert centre distance:
44 x 27 mm, 57 x 27 mm,
77.5 x 27 mm, 104 x 27 mm

insert carrier blocks for mobile mounting



insert carrier insulated housings for mobile mounting



description

part No.

part No.

kit with 2 elements, for coupling of inserts
 with screw fixing centre distance (short side = 27 mm)
 - with handle for cable support bands
 - with handle for cable support or cable clamp bands

COB TSF
COB TSFS

side entry, with cable clamp
 for insert coupling:

- with screw fixing centre distance of 44 x 27 mm
 - with screw fixing centre distance of 57 x 27 mm
 - with screw fixing centre distance of 77.5 x 27 mm
 - with screw fixing centre distance of 104 x 27 mm

COB 06 CMS
COB 10 CMS
COB 16 CMS
COB 24 CMS

dimensioni in mm

COB TSF

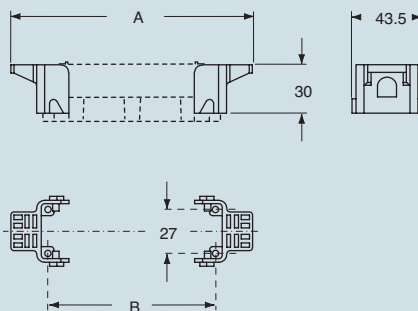

COB TSFS

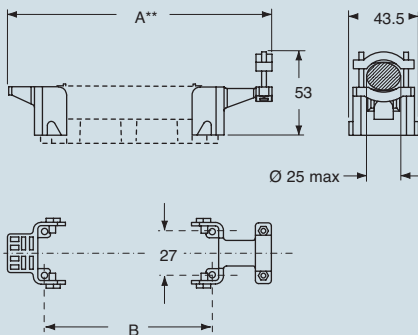

dimensioni in mm

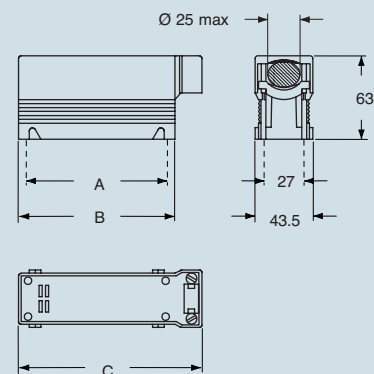

part No.	A	B	C
COB 06 CMS	44	58	74
COB 10 CMS	57	71	87
COB 16 CMS	77.5	91.5	107.5
COB 24 CMS	104	118	134

for inserts	A	A**	B
with centre distance 44 x 27 mm	90	104	44
with centre distance 57 x 27 mm	103	117	57
with centre distance 77.5 x 27 mm	123.5	137.5	77.5
with centre distance 104 x 27 mm	150	164	104

dimensions indicated are not binding
 and may be changed without notice

inserts:		page
CD	15, 25 poles + ⊕	41-42
CDD	38 poles + ⊕	54
CDA	10, 16 poles + ⊕	66÷68
CDC	10, 16 poles + ⊕	67÷69
MIXO	1 module	137÷151

insert centre distance:
49.5 x 16 mm
66 x 16 mm

adaptor plates for insert mounting



levers for coupling with metallic enclosures



description	part No.	part No.
mounting on COB series articles (see below) for 1 insert with screw fixing centre distance of 49.5 x 16 mm	CR 15/16	
mounting on COB series articles (see below) for 1 insert with screw fixing centre distance of 66 x 16 mm	CR 25/16	
kit with 2 elements, to be mounted instead of the standard levers to be coupled with: COB TCQ and COB...BC ¹⁾		COB L

Adaptor plates

- allow the inserting of inserts of "49.16" and "66.16" on the following COB articles:
 COB TCQ, COB 16 BC, COB TSF, COB TSFS, COB 16 CMS

¹⁾ They allow the mounting of aluminium hoods with 4 pegs, size 55.27, 77.27 and 104.27

dimensions in mm

CR 15/16

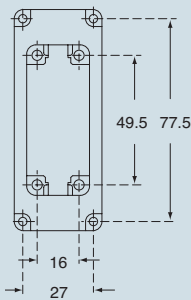

CR 25/16

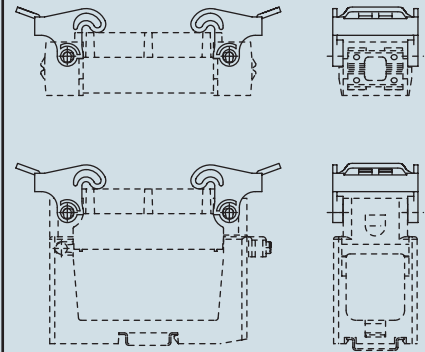
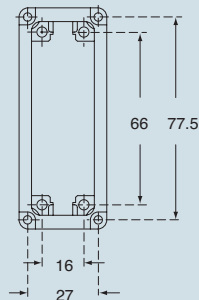

dimensions indicated are not binding and may be changed without notice

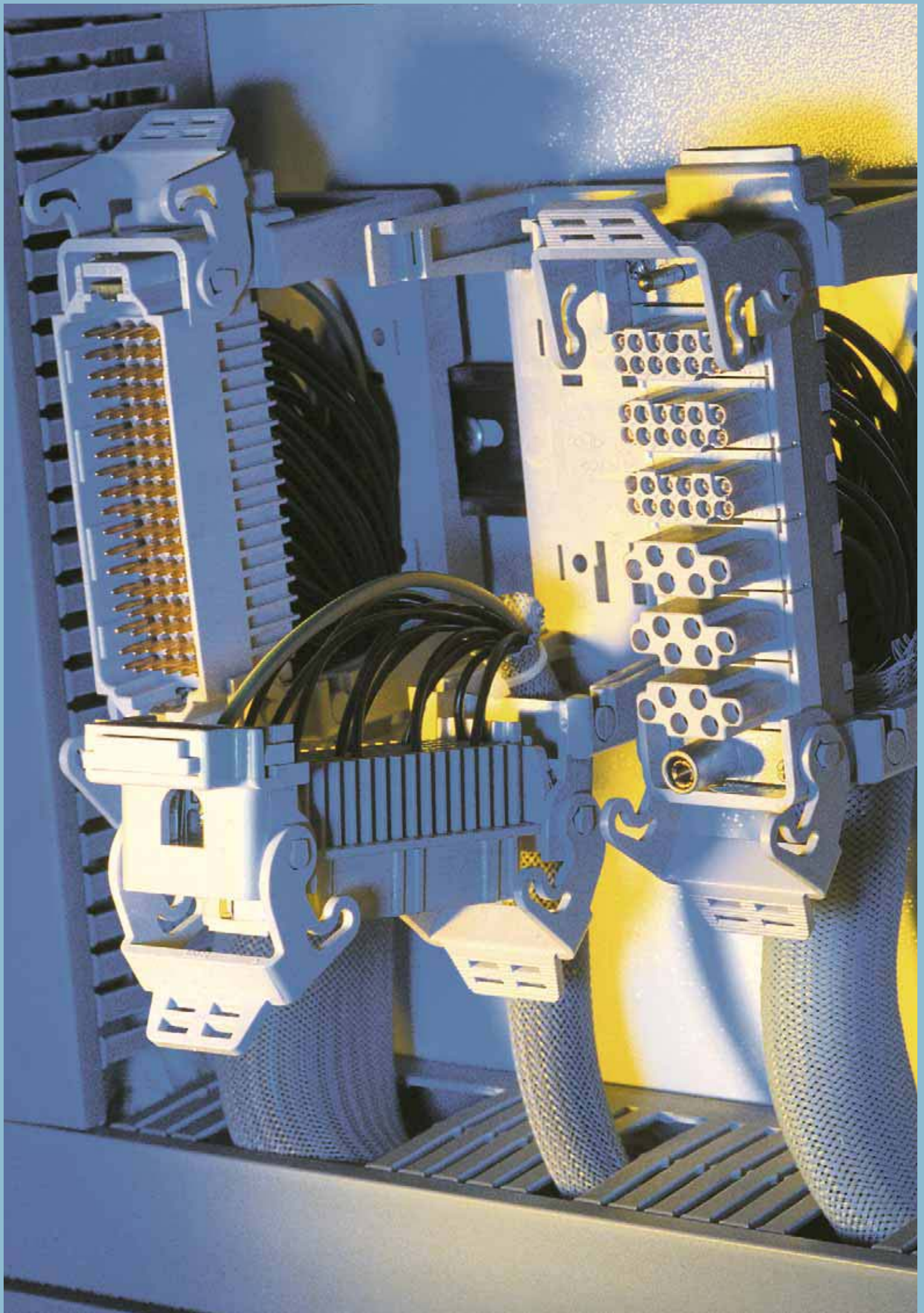

panel fitted insert fastening screws



screws for second earth terminal



description	part No.	part No.
to be fitted instead of the current insert fastening screws	CRIC M3	
<ul style="list-style-type: none"> - for CDA/CDC inserts - for CD 15/25, CDD 38 inserts - for CD 40/64, CDD 24/42/72/108, CQE, CN, CNE, CSS, CX 8/24, CCE, CSE, CMSE, CME, CMCE inserts - for CP, CX 12/2, CX 6/36, CX 4/0, CX 4/2 inserts 		<ul style="list-style-type: none"> CR VATG CR VDTG CR VNTG CR VPTG

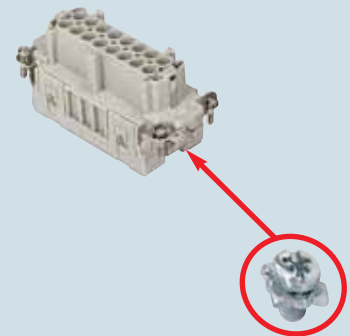
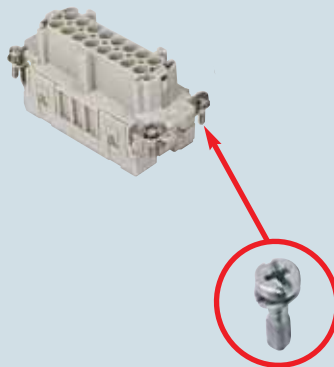

accessories

dimensions indicated are not binding and may be changed without notice

support for rail mounting
DIN EN 60715



CT/CTS/CTE/CTSE inserts coupling screws
cable-clamping plates



description	part No.	part No.
supports for CT, CTS, CTE, CTSE inserts	CT APE	
bush for CT, CTS, CTE, CTSE inserts screw pin for CN, CD, CNE, CCE, CSE inserts		CRBF CRBM
straight cable clamping plate angled cable clamping plate		CRAD CRAS

Coupling screws for CT/CTE inserts

The use of CRBF (female) and CRBM (male) coupling screws is recommended to guarantee a stable and safe coupling between inserts (without enclosures) with terminal blocks and inserts without terminal blocks.

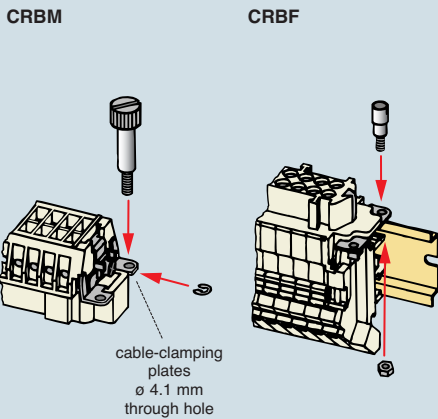

dimensions in mm

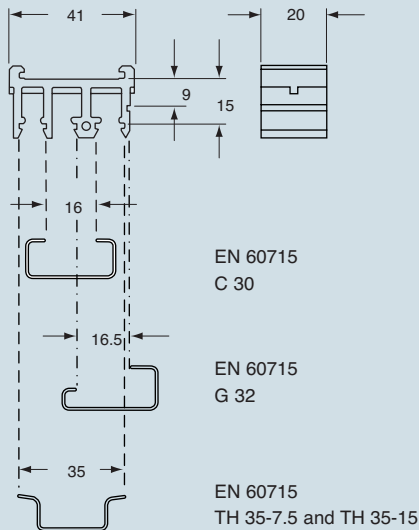

dimensions in mm

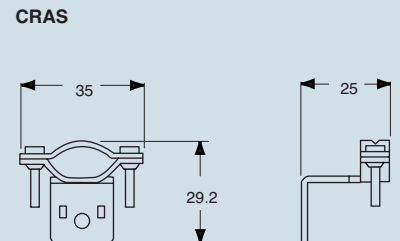
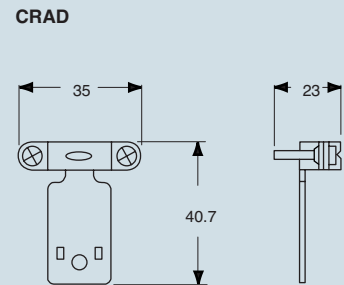
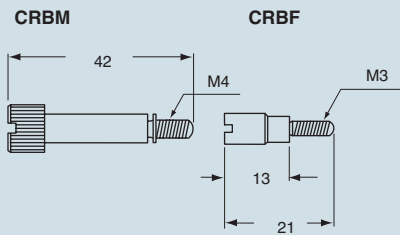

Note: for conductor groups or cable with \varnothing min = 12 mm and \varnothing max = 23 mm

Use of cable-clamping plates

In accordance with the recommendations of standard IEC 60352-2, the weight of the conductor groups or multipolar cables must not cause any stress on the contacts inside the inserts. It is therefore advisable to use cable-clamping plates in those inserts without enclosures

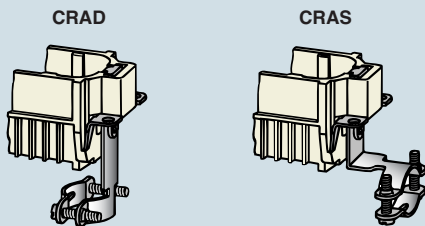

dimensions indicated are not binding and may be changed without notice

inserts:		pag.
CD	24 poles + ⊕	53
CDD	42 poles + ⊕	55
CDD	72 poles + ⊕	56
CDD	108 poles + ⊕	58
CX	8/24 poles + ⊕	129
CX	6/36 poles + ⊕	130
CX 12 (MIXO)	12 poles	144

interface for printed circuit

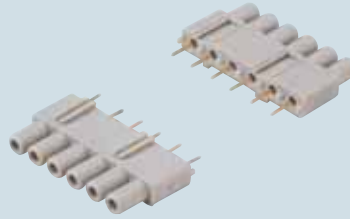

6A contacts for interface silver and gold plated



description	part No.	part No.	part No.
interface module with 6 female contacts (gold) - for up to 2.4mm thick PCB	CIF 2.4		
interface module with 6 female contacts (plated) - for up to 2.4mm thick PCB	CIF 2.4 A		
6A female contacts for female inserts with terminal Ø 1 mm		CDFA 6A	CDFD 6A
6A male contacts for male inserts with terminal Ø 1 mm		CDMA 6A	CDMD 6A

CIF interface

The interface block is made according to the multipole connector used by assembling a suitable number of CIF modules (see table).

inserts serie	poles n°	modules "CIF" n°
CDD	24	4
CDD	42	7
CDD	72	12
CDD	108	18
CX	8/24	4
CX	6/36	6
CX (MIXO)	12	2

The block is then welded on the printed circuit on which the multipole connector (female or male) equipped with coupling contacts will then be inserted.

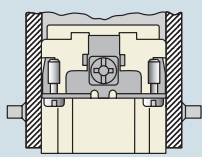

Connector female or male insert

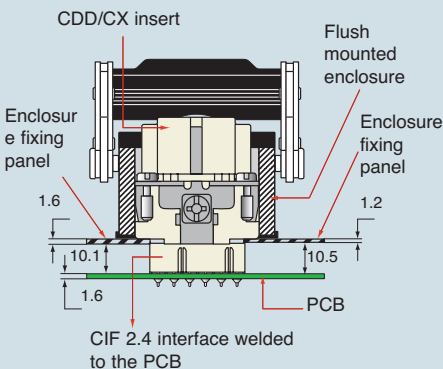

dimensions indicated are not binding and may be changed without notice

dimensions in mm

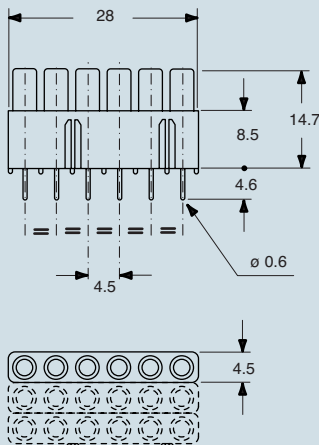

dimensions in mm

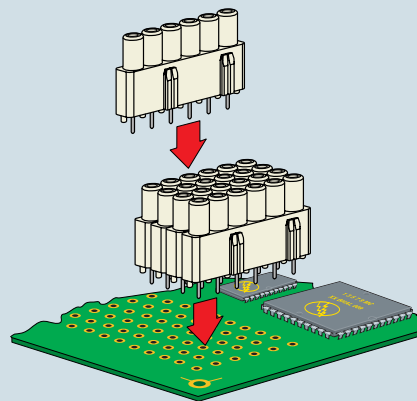
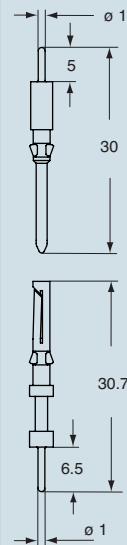

inserts	page
CDC 10, 16 poles + ⊕	67÷69
CQ 5 poles + ⊕	63
CQE .. 10, 18, 32, 46, 64,92 poles + ⊕	74÷79
CCE 6, 10, 16, 24, 32, 48 poles + ⊕	86÷96
CMCE 3+2, 6+2, 10+2, 16+2, 12+4, 20+4, 32+4 poles + ⊕	114÷125
CX 8/24 poles + ⊕	129
CX 06 C 6 poles serie MIXO	140

- for crimp contacts, see the crimp tool section (16A, CCF and CCM series contacts) pages 296, 300, 304, 306, 308
 - for thermocouples compliant with DIN IEC 584 type J
 - contact resistance ≤ 1 ohm

**constantan (Cu Ni)
crimp contacts**



NEW

**iron (Fe)
crimp contacts**



NEW

description	part No.	part No.
16A, 0.5 mm ² , AWG 20 female contacts	CCFC 0.5	CCFF 0.5
16A, 0.5 mm ² , AWG 20 male contacts	CCMC 0.5	CCMF 0.5

Note:
 A mixed combination of standard iron, Constantan and silver and gold plated contacts can be fitted in the same insert.

dimensioni in mm

CCF and CCM

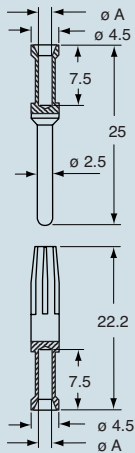

CCF and CCM contacts

conductor section mm ²	slot A (mm)
0.5	1.1

- stripping length see section feature of inserts at page 13

dimensioni in mm

CCF and CCM

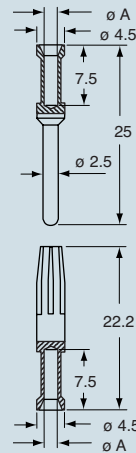

CCF and CCM contacts

conductor section mm ²	slot A (mm)
0.5	1.1

- stripping length see section feature of inserts at page 13

dimensions indicated are not binding and may be changed without notice

enclosures:

MIXO seriesfrom page 137

CX 02 GF/M *

ground terminals for shielded cables
(for MIXO series)
clamps for cables Ø 5 mm and Ø 10 mm



anchorages for earth connecting several
cables (for MIXO series)

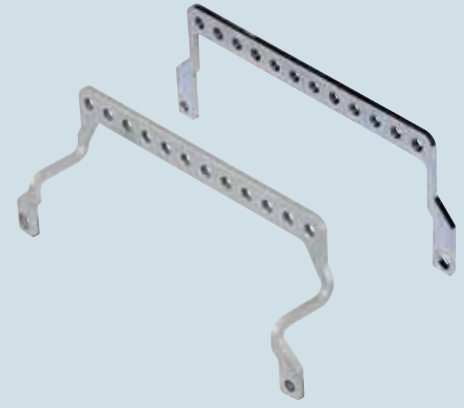

description	part No.	part No.
in zinc iron, to be mounted on MIXO frames in bulkhead mounting housings and high construction hoods - enclosures "44.27" and MIXO frames for 2 inserts - enclosures "57.27" and MIXO frames for 3 inserts - enclosures "77.27", "77.62" and MIXO frames for 4 inserts - enclosures "104.27", "104.62" and MIXO frames for 6 inserts	CR 06 ST CR 10 ST CR 16 ST CR 24 ST	
to be mounted on CR..ST ground terminals clamp for shielding cables Ø 5 mm clamp for shielding cables Ø 10 mm	CR 05 CA CR 10 CA	
in zinc iron, to be mounted on MIXO frames in bulkhead mounting housings and high construction hoods - enclosures "44.27" and MIXO frames for 2 inserts - enclosures "57.27" and MIXO frames for 3 inserts - enclosures "77.27", "77.62" and MIXO frames for 4 inserts - enclosures "104.27", "104.62" and MIXO frames for 6 inserts		CR 06 AT CR 10 AT CR 16 AT CR 24 AT

* only with CR 24 ATD

accessories

Anchorage CR .. ST are designed for installation on the frames of the MIXO modular connectors, for earth connecting the screening braid of shielded cables.

With the CR..ST anchorages we advise you to use high construction hoods top entry.

Anchorage CR .. AT / ATD are designed for installation on the frames of the MIXO modular connectors for earth connecting several cables.

dimensions in mm

CR...ST

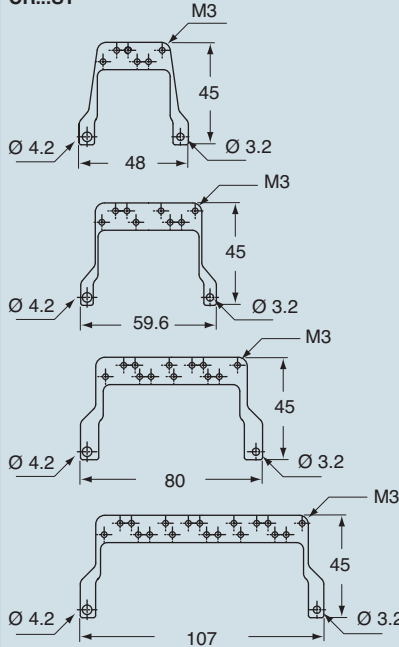

CR...CA

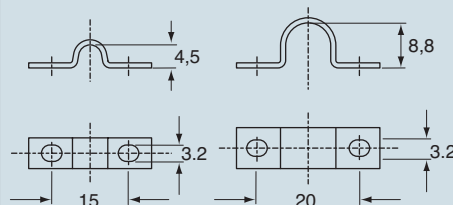

dimensions in mm

CR...AT

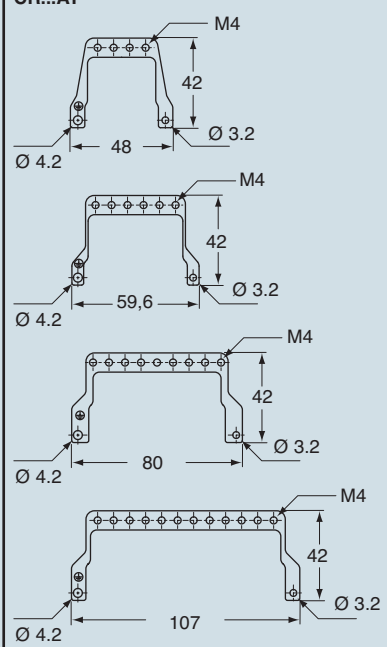

CR...ATD

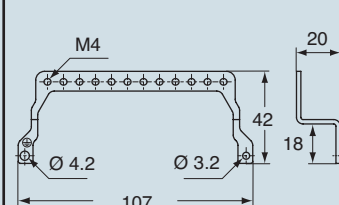

dimensions indicated are not binding and may be changed without notice

inserts:	page
CD..... 40, 64 poles + ⊕	43÷45
CDD 24, 42, 72, 108 poles + ⊕	53÷58
CQE 10, 18, 32, 46 poles + ⊕	74÷77
CN 6, 10, 16, 24 poles + ⊕	80÷83
CCE 6, 10, 16, 24 poles + ⊕	86÷92
CNE, CSE.. 6, 10, 16, 24 poles + ⊕	87÷93
CSS 6, 10, 16, 24 poles + ⊕	98÷101
CP 6 poles + ⊕	127
CX 8/24, 12/2, 6/36 poles + ⊕	129÷131

screw fixing centre distance:
44 x 27 mm, 57 x 27 mm,
77.5 x 27 mm, 104 x 27 mm

**ground terminals for shielded cables and for earth connecting several cables
 clamps for cables Ø 0.5 mm and Ø 10 mm**



NEW

description	part No.
in zinc plated iron, to be fitted on connectors in flush mounted fixed, portable high and COB series enclosures - "44.27" enclosures and inserts - "57.27" enclosures and inserts * - "77.27", "77.62" enclosures and inserts - "104.27", "104.62" enclosures and inserts - CSS "104.27" enclosures and inserts **	CR 06 SC CR 10 SC CR 16 SC CR 24 SC CR 24 SCA
to be fitted on CR..SC anchors U-bolt for Ø 5mm cable screening U bolt for Ø 10mm cable screening	CR 05 CA CR 10 CA

The CR... SC anchors are fitted on connectors for connecting to earth multiple cables and screened cables braids

With the CR..SC anchorages, we advise you to use high construction hoods top entry.

* the high portable enclosures with horizontal exit cannot be used

** can be used only in flush mounted enclosures

dimensions in mm

CR...SC

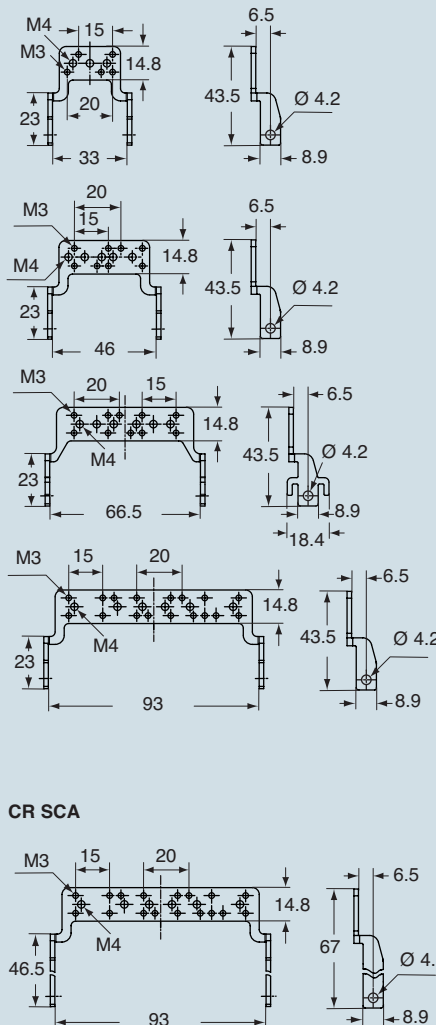

CR...CA

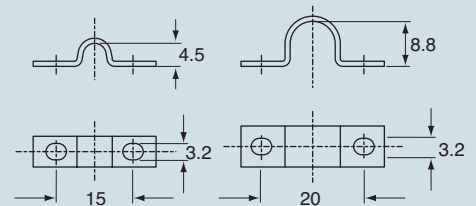

dimensions indicated are not binding
 and may be changed without notice

The CR..FS series anchorages are employed for use of connector inner fittings (normal or MIXO modular) without enclosures and enable securing cables with clamps to prevent transmitting friction forces to contacts. CR..SS anchorages (with grip to facilitate detachment) are used for earth connecting several conductors and/or of the screen of shielded cables

* except CT, CTS, CTE and CTSE

grip panels for cables outside enclosure equipped with fixing screws and rings



supports, screws and clamps for grip panels of cables outside enclosure



description	part No.	part No.
in zinc iron, to be mounted on: - inserts size "44.27" * and MIXO frames for 2 inserts - inserts size "57.27" * and MIXO frames for 3 inserts - inserts size "77.27" * and MIXO frames for 4 inserts - inserts size "104.27" * and MIXO frames for 6 inserts	CR 06 FS CR 10 FS CR 16 FS CR 24 FS	
for shielded cables, to be mounted on: - inserts size "77.27" * and MIXO frames for 4 inserts - inserts size "104.27" * and MIXO frames for 6 inserts	CR 16 SS CR 24 SS	
supports in die-cast zinc N° 2 pieces equipped with fixing screws and rings for earth connecting		CR SP
short screws in zinc iron, N° 2 pieces long screws in zinc iron, N° 2 pieces		CR 26 V CR 42 V
to be mounted on CR..SS anchorage clamp for shielding cables Ø 5 mm clamp for shielding cables Ø 10 mm		CR 05 CA CR 10 CA

In the fixed part, a pair of CR SP supports is fitted on the connector, using its securing screws. A CR..FS or CR..SS anchorage is fitted on the supports, using the supplied securing screws and washers. All parts are secured on the rear panel with the pair of CR 26 V viton screws.

In the mobile part too, a pair of CR SP supports are fitted on the connector and a CR..FS or CR..SS anchorage is secured on it. The pair of CR 42 V screws fasten the mobile part to the fixed part.

Note: By unscrewing the CR 26 V panel screws, the whole assembly (mobile part+fixed part) can be removed from the panel for inspection.

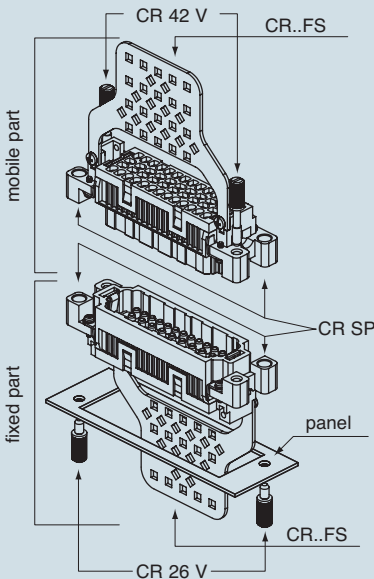

dimensions indicated are not binding and may be changed without notice

dimensions in mm

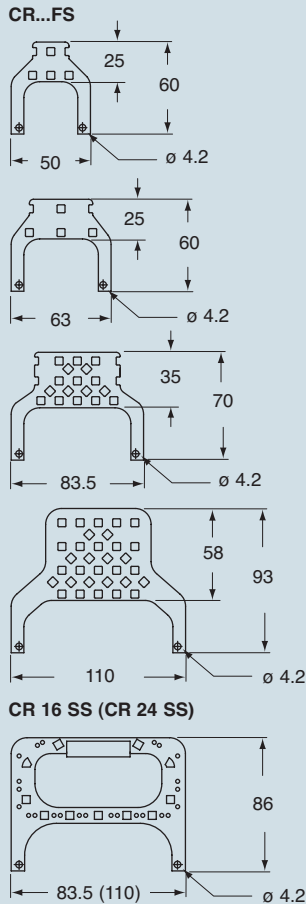

dimensions in mm

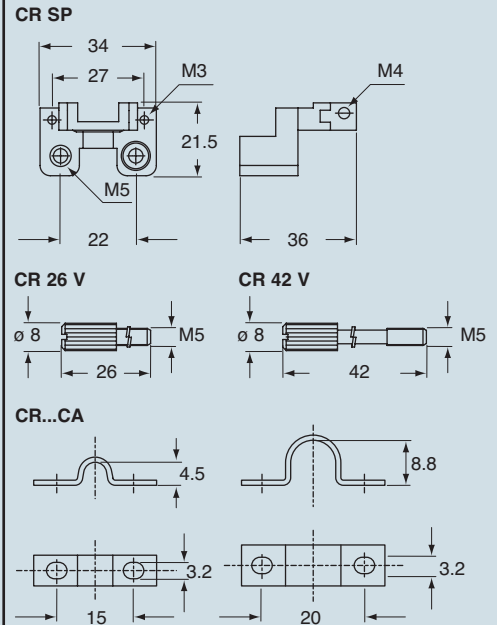

panel cut-out

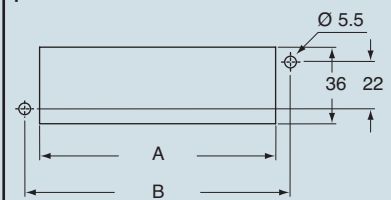

poles	06	10	16	24
A	52	65	85.5	112
B	65	78	98.5	125

accessories

single code pins for 6 codings

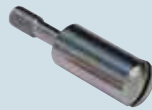

selectivity using single code pins



description	part No.	part No.
single code pin (not for MIXO inserts)	stainless steel CR 20	zinc plated iron CR 20 D
single code pin (for MIXO inserts only)	stainless steel CR 20 CX	zinc plated iron CR 20 CX D

CR 20/CR 20 D and CR 20 CX/CR 20 CX D code pins

Each series of connector inserts is made in such a way as to make incorrect coupling between inserts of different series impossible.

When a number of identical connectors with different functions are mounted closely together these must be selected in such a way as to prevent the coupling of a mobile part on a non-corresponding fixed part and consequent damage and breakdown.

Code pins are supplied to apply in place of the normal insert fastening screws (see example below). In this way the coupling of identical connectors is assured. The combination of code pins makes it possible to obtain a high number of selective couplings.

dimensions in mm

CR 20 / CR 20 D

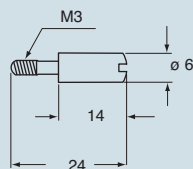

CR 20 CX / CR 20 CX D

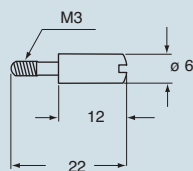

application with single insert

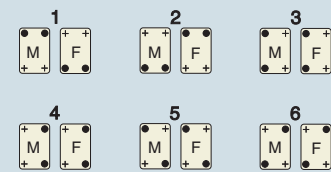

application with double inserts

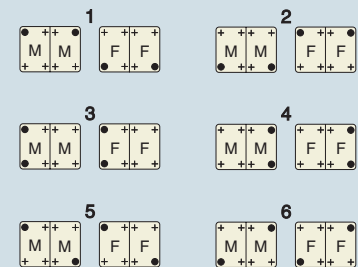

- code pin (CR 20/CR 20 D and CR 20 CX/CR 20 CX D)
- + normal fixing screw
- M = male insert
- F = female insert

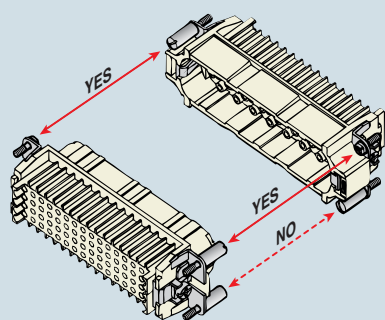

dimensions indicated are not binding and may be changed without notice

dual coding and guide pins, for 16 codes

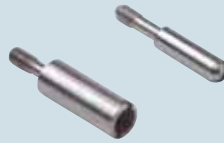

selection is made by using dual coding and guide pins



description	part No.	part No.
dual coding pins (excluding MIXO inserts) - male pin - female pin	stainless steel CRM CRF	zinc plated iron CRM D CRF D
double code pins (for MIXO inserts only) - male pin - female pin	stainless steel CRM CX CRF CX	zinc plated iron CRM CX D CRF CX D

application with single insert

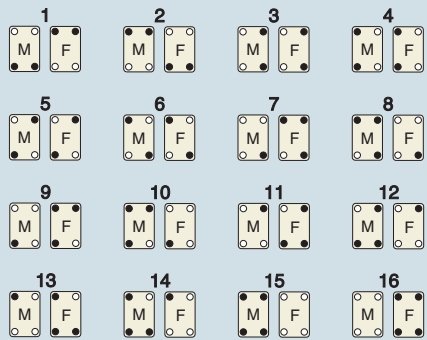

Code pins
- CRM/CRM D and CRF/CRF D
- CRM CX/CRM CX D and CRF CX/CRF CX D

Each series of connector inserts is made in such a way as to make incorrect coupling between inserts of different series impossible. When a number of identical connectors with different functions are mounted closely together these must be selected in such a way as to prevent the coupling of a mobile part on a non-corresponding fixed part and consequent damage and breakdown.

Code pins are supplied to apply in place of the normal insert fastening screws (see example below). In this way the coupling of identical connectors is assured. The combination of code pins makes it possible to obtain a high number of selective couplings.

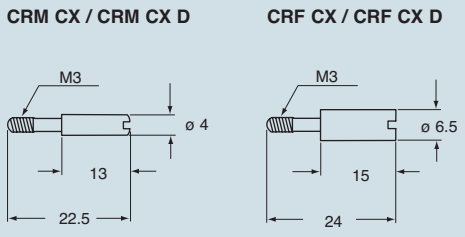
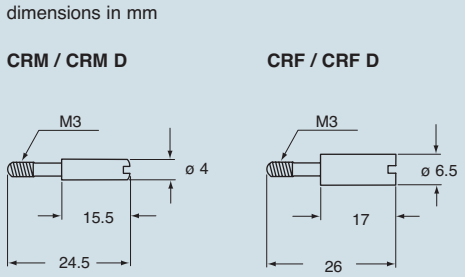

application with double inserts

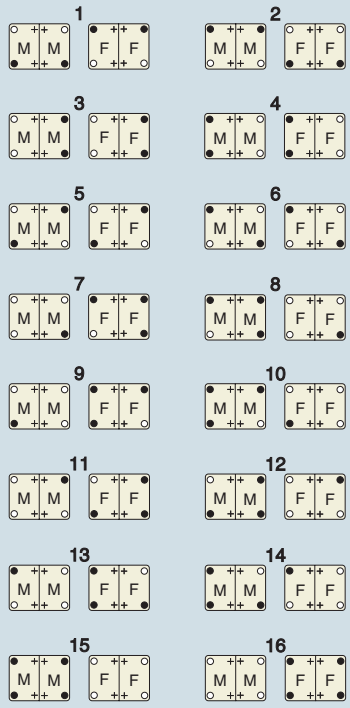

- female code pin (CRF/CRF D and CRF CX/CRF CX D)
- male code pin (CRM/CRM D and CRM CX/CRM CX D)
- + normal fixing screw
- M = male insert
- F = female insert

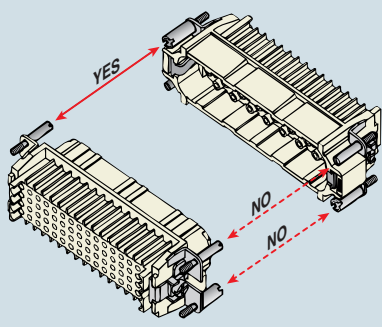

Even when coding is not required, it is recommended to use CRM and CRF pins with CD and CDD inserts to reduce movements when fitting and removing the connectors and to avoid contact damages. Within this scope, the standard DIN 43 652 requires a maximum angular longitudinal fluctuation of ±5°.

dimensions indicated are not binding and may be changed without notice

accessories

plain coding pins
for crimp inserts



NEW

plain coding pins
for CQ 12 inserts



NEW

description	part No.	part No.
coding pins for CDC, CQ, CQE, CCE, CMCE, MIXO (16A) inserts - pin to be inserted instead of a crimp contact	CR CPQ	
coding pins for CD 07 and CD 08 inserts - plastic pin, to be inserted instead of a crimp contact	CR CP	
coding pins for CQ 12 inserts		CR Q12

Code pins

Each series of connector inserts is made in such a way as to make incorrect coupling between inserts of different series impossible.

When a number of identical connectors with different functions are mounted closely together these must be selected in such a way as to prevent the coupling of a mobile part on a non-corresponding fixed part and consequent damage and breakdown.

Within this scope, special coding pins have been manufactured in order to restrict or avoid mating identical multiple connectors.

By combining multiple coding pins, a high number of selected matings can be produced.

dimensions in mm

CR CPQ

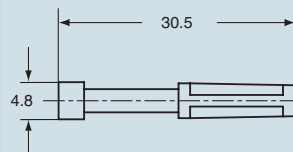

CR CP

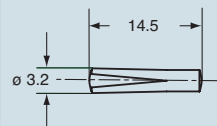

dimensions in mm

CR Q12

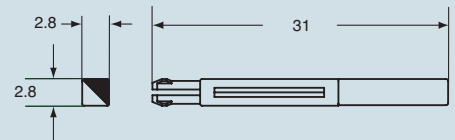

application with single insert

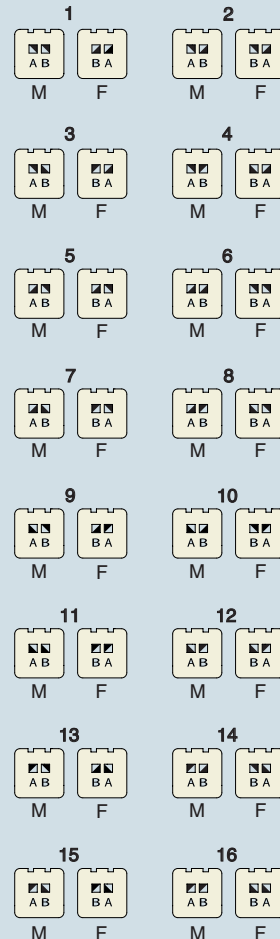

M = male insert
F = female insert

(A B) CQ 12 coding pin

dimensions indicated are not binding
and may be changed without notice

**terminal connector
for CKF 03 inserts**



NEW

description	part No.
with pegs and seal, connects pole 2 with pole 3 with pegs and seal, connects pole 1 with pole 3 with pegs and seal, connects pole 1 with pole 2	CKM 03 T1 CKM 03 T2 CKM 03 T3

When the terminal connector is mated with a CKF 03 insert (complete with an enclosure with lever), it performs a dual function:
 - connects two socket insert poles
 - acts as a cover (IP65 protection rating compliant with EN 60529 standard, with lever closed)

dimensions in mm

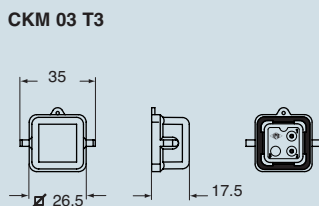
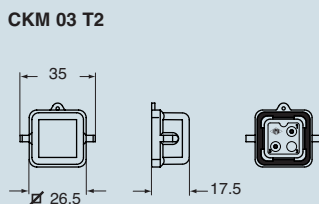
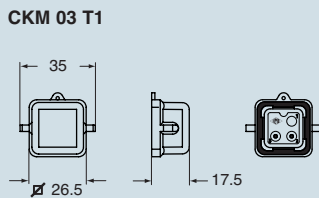

● interconnected male contacts

dimensions indicated are not binding
and may be changed without notice

insert joining block



metal replacement handles



description	part No.	part No.
-------------	----------	----------

made of die cast aluminium alloy to mate two inserts (see below)

CBGF

to replace thermoplastic handles
2 component kit for dual lever enclosures ¹⁾

CR TM-1

¹⁾ can only be used on dual lever enclosures sizes 57.27, 77.27 and 104.27

dimensions in mm

CBGF combination block

- Allows two "44.27 size" inserts to be inserted in "104.27 size" enclosures and on the following COB series items:
COB TCQ, COB 24 BC, COB TSF, COB TSFS, COB 24 CMS
- Allows female contacts and male contacts in the same enclosure or mounting
- Allows mixed type contacts in the same enclosure or mounting (for example, 6 poles 16A CNF + 24 poles 10A CDDF)

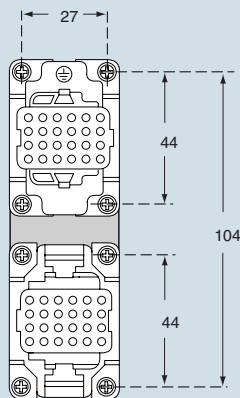
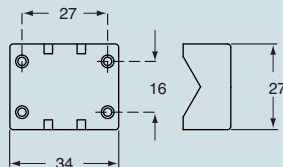
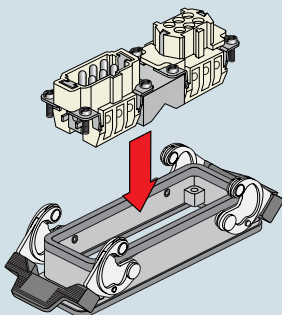

enclosures

(with two levers only):

- size "57.27"from page 184
- size "77.27"from page 198
- size "104.27"from page 212

enclosures :
size "104.27"from page 212

panel supports:
COBfrom page 258

inserts with screw fixing centre distance:
(2x) 44 x 27 mm

dimensions indicated are not binding and may be changed without notice

enclosures:
size "104.27".....from page 212

temporary protection cover
for transportation

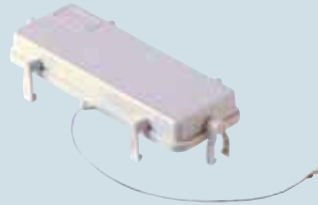

pliers for uncoupling connectors



description

part No.

part No.

for housings and hoods
- with 1 or 2 levers, with 2 or 4 pegs

CPT 24

for housings and hoods
- with 2 levers and 4 pegs

CPES

use

CPT 24 for enclosures with 2 levers

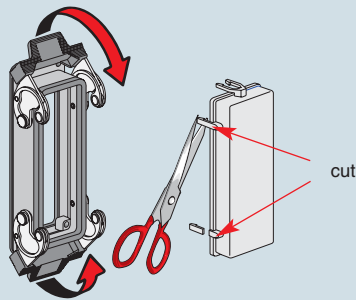

CPT 24 for enclosures with 4 pegs

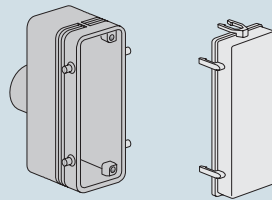

CPT 24 for enclosures with 1 lever

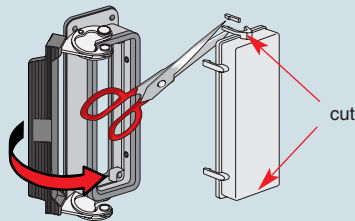

CPT 24 for enclosures with 2 pegs

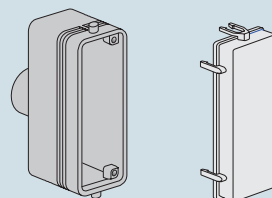

use

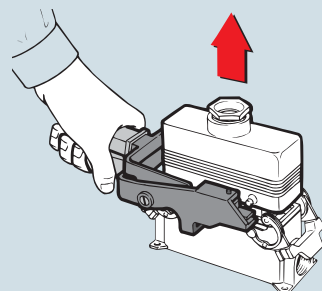
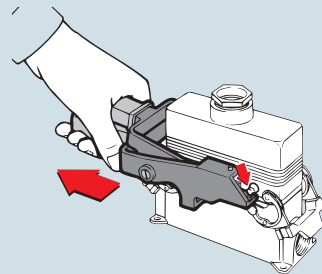
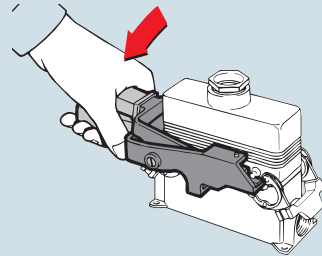
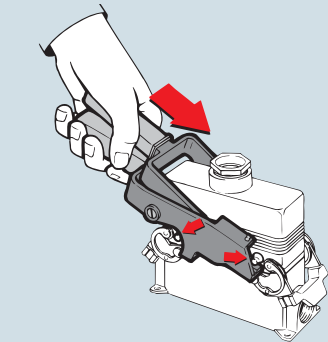

accessories

enclosures:

- size "49.16" from page 162
- size "66.16" from page 166
- size "44.27" from page 176
- size "57.27" from page 184
- size "77.27" from page 198

Use M3 passing screws tightened with nut and washer (not included). Verify connection continuity of coupled connectors

plates for D-SUB inserts (IEC 60807-2)
CZ / MZ / MZF enclosures



plates for D-SUB inserts (IEC 60807-2)
CH / CA and MH / MA / MF enclosures



description	part No.	for enclosures size	part No.	for enclosures size
for 1 D-SUB insert 9 poles (not included)	CR 09 AD	"49.16"	CR 09 AD1	"44.27"
for 1 D-SUB insert 15 poles (not included)	CR 15 AD	"49.16"	CR 15 AD1	"44.27"
for 1 D-SUB insert 25 poles (not included)	CR 25 AD	"49.16"	CR 25 AD1	"57.27"
for 1 D-SUB insert 37 poles (not included)	CR 37 AD	"66.16"	CR 37 AD1	"77.27"
for 1 D-SUB insert 50 poles (not included)	CR 50 AD	"66.16"	CR 50 AD1	"77.27"
for 2 D-SUB inserts 9 poles (not included)			CR 09 AD2	"44.27"
for 2 D-SUB inserts 15 poles (not included)			CR 15 AD2	"44.27"
for 2 D-SUB inserts 25 poles (not included)			CR 25 AD2	"57.27"
for 2 D-SUB inserts 37 poles (not included)			CR 37 AD2	"77.27"
for 2 D-SUB inserts 50 poles (not included)			CR 50 AD2	"77.27"

Plates CR...AD, CR...AD1 and CR...AD2

For machinery or command equipment that need connection with programming and control electronic devices. The plate housings have notches for the rear insertion of cabled D-SUB inserts.

CR...AD

mounting on bulkhead housings and hoods
one-way mounting in bulkhead housings or hoods.

CR...AD1 and CR...AD2

mounting on bulkhead housings (Figure 1)
The D-SUB connector must be mounted on the side marked with the letter "A"

mounting on hoods (Figure 2)

The D-SUB connector must be mounted on the side marked with the letter "T"

dimensions in mm

CR...AD

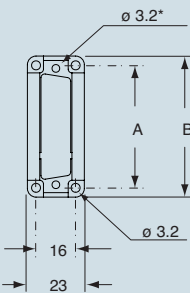

* For passing screws type M3

the electrical continuity is guaranteed only if mounted in our enclosures.

part No.	A	B
CR 09 AD	49.5	56.5
CR 15 AD	49.5	56.5
CR 25 AD	49.5	56.5
CR 37 AD	66	73.5
CR 50 AD	66	73.5

dimensions in mm

CR...AD1

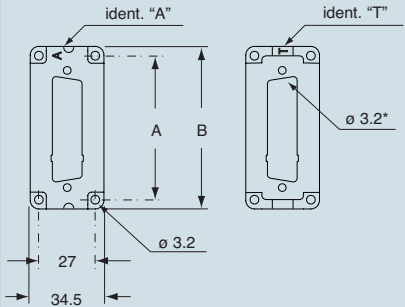

Figure 1

Figure 2

CR...AD2

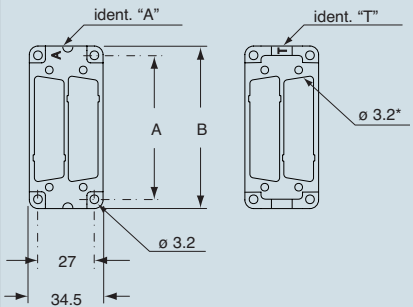
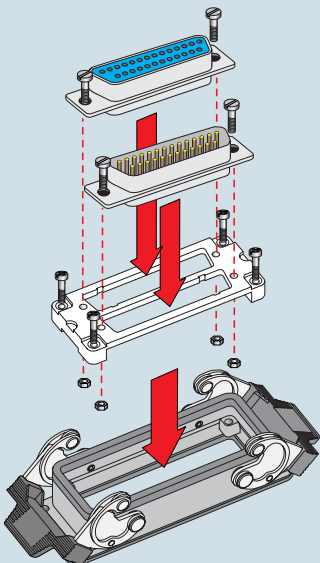

Figure 1

Figure 2

* For passing screws type M3

part No.	A	B
CR 09 AD1 / 2	44	51.5
CR 15 AD1 / 2	44	51.5
CR 25 AD1 / 2	57	64.5
CR 37 AD1 / 2	77.5	85
CR 50 AD1 / 2	77.5	85



dimensions indicated are not binding and may be changed without notice

enclosures *): **size "104.62"**
standard.....page 232

*1) normally bulkhead type

**kit for control equipment
plate only**



**kit for control equipment
plate with enclosure**



description	part No.	for enclosure	part No.
with Schuko® socket 16A and 2 seats for: CR 09 AD, CR 15 AD, CR 25 AD plates	SDS	CHI 48 LS	
with Schuko® socket 16A and 2 seats for: CR 09 AD, CR 15 AD, CR 25 AD plates			CHSDS

Kit for control equipment

For machinery or command equipment that need connection with programming and control electronic devices.

The kit includes the Schuko® socket and 2 seats for the CR...AD plates (not included) for D-SUB inserts (not included).

Personal computers, notebooks or printers can be power supplied using a 16A socket. Monitors, printers and other peripheral devices may be interfaced using D-SUB connectors

dimensions in mm

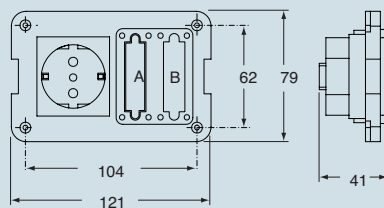

dimensions in mm

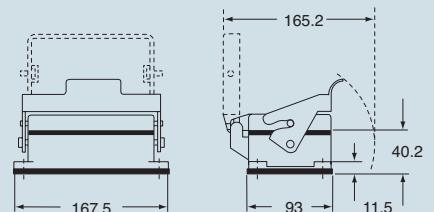

CR...AD plates usable

part No.	
CR 09 AD	for 1 D-SUB insert 9 poles (not included)
CR 15 AD	for 1 D-SUB insert 15 poles (not included)
CR 25 AD	for 1 D-SUB insert 25 poles (not included)

Closed seat "A" for use with one insert only. The closing is achieved by means of a plastic membrane that can easily be removed if the second seat is required.

CR.. AD plates to be ordered separately

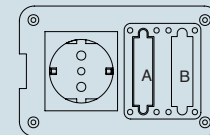

housing panel cut-out in mm

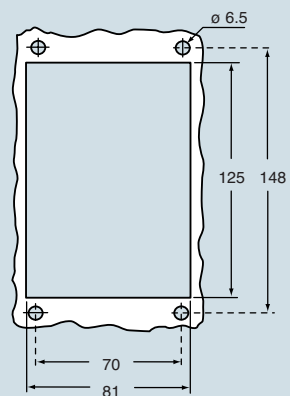

dimensions indicated are not binding and may be changed without notice

enclosures:

- size "44.27"from page 176
- size "57.27"from page 184
- size "77.27"from page 198
- size "104.27"from page 212

24 pole closure or reduction plate



extraction tool for MIXO BUS connectors



description	part No.	part No.
in autoextinguishing thermoplastic resin with gasket in vinyl-nitrile elastomer	CRH 24	
in self-extinguishing thermoplastic resin with gasket in vinyl-nitrile elastomer - for enclosures CHI size "44.27" - for enclosures CHI and CMI size "57.27" - for enclosures CHI and CMI size "77.27" - for enclosures CHI and CMI size "104.27"	CRZ 06 CRZ 10 CRZ 16 CRZ 24	
for the extraction of the BUS shielded connectors from the MIXO BUS insert		CX BES

dimensions in mm

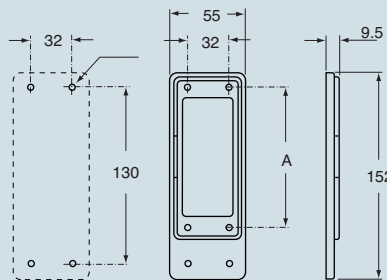
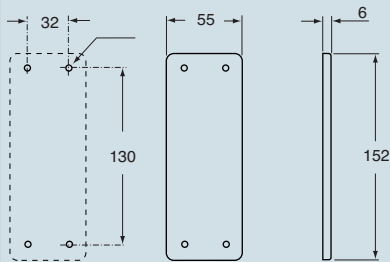

CRZ	A
06	70
10	83
16	103
24	130

dimensions indicated are not binding and may be changed without notice

enclosures: **size "21.21"**
insulating typepage 288÷289
metallic typepage 290÷291

- for crimping a male connector, see the crimp tool section page 310

adapter for RJ45 connectors



RJ45 connectors

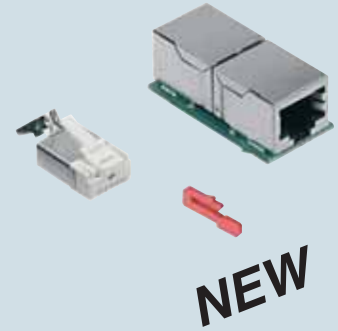

description	part No.	part No.
without RJ45 connector (to be ordered separately) - adapter for RJ45 female connector in fixed enclosures	CJ KF	
- RJ45 female connector with 4 data contacts - RJ45 female connector with 4 data contacts / 2 power contacts		CX 8 JF CX 8/2 JF
without RJ45 connector (to be ordered separately) - adapter for RJ45 male connector in portable enclosures	CJ KM	
- RJ45 male connector with 4 data contacts - RJ45 male connector with 4 data contacts / 2 power contacts - RJ45 male connector with 6 data contacts / 2 power contacts - RJ45 male connector with 8 data contacts - RJ45 male connector with 4 data contacts, Class 5e		CX 4 JM CX 4/2 JM CX 6/2 JM CX 8 JM CX 4E JM

- RJ45 connector features:**
- RJ45 connector, Class 5 or Class 5e
 - nominal current: 2.1A at 70 °C
 - nominal voltage: 50VDC / 35VAC
 - IDC terminal:
 - for data wires from 0.22 mm² to 0.24 mm² (AWG 24)
 - for power wires from 0.34 mm² to 0.38 mm² (AWG 22)
 - temperature range: from -20 °C to +120 °C
 - nickel plated brass screening
 - insert coding pin: **CR KC**
 - self-extinguishing properties: to UL 94V-0
 - crimp pliers: **CJPZY**
 - screened cables stripping tool: **CJST**
 - female/female socket connectors with "crossover" link

How to use CR KC coding pins

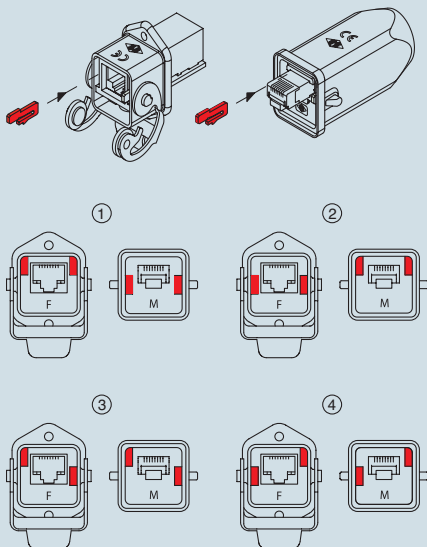

dimensions in mm

CJ KF, CJ KM

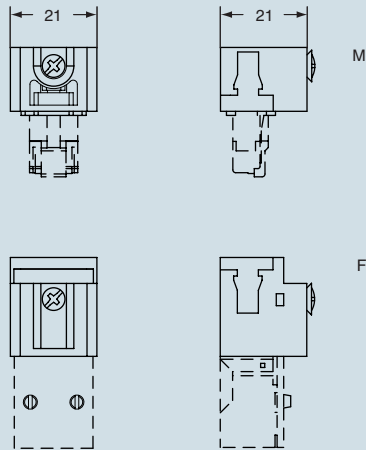

contacts side (front view)

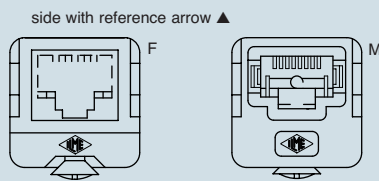

dimensions in mm

CX 8 JF, CX 8/2 JF

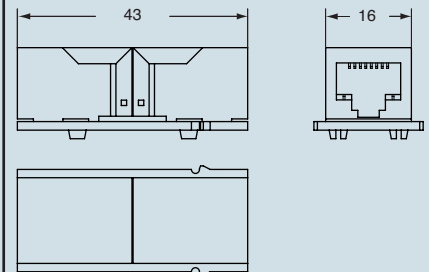

CX 4 JM, CX 4E JM, CX 4/2 JM, CX 6/2 JM, CX 8 JM

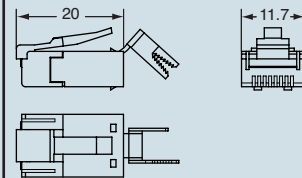

dimensions indicated are not binding and may be changed without notice

accessories

Allows two complete portable RJ45 connectors to be joined, IP65/IP67 version

insulated version coupling, for RJ45 connectors

metal version coupling, for RJ45 connectors



NEW



NEW

description

part No.

part No.

- female RJ45 coupling, 8 data contacts
- female RJ45 coupling, 8 data contacts / 2 power contacts

CYG 8 JF
CYG 8/2 JF

- female RJ45 coupling, 8 data contacts
- female RJ45 coupling, 8 data contacts / 2 power contacts

CYG 8 JFA
CYG 8/2 JFA

RJ45 connector features:

- RJ45, Class 5 connector
- nominal current: 2.1A at 70 °C
- nominal voltage: 50VDC / 35VAC
- temperature range: from -20 °C to +120 °C
- nickel plated brass screening
- insert coding pin: CR KC
- self-extinguishing properties: to UL 94V-0
- die cast zinc alloy metal enclosures
- black self-extinguishing thermoplastic insulated enclosures
- female/female socket connectors with "crossover" link

dimensions in mm

CYG 8 JF, CYG 8/2 JF

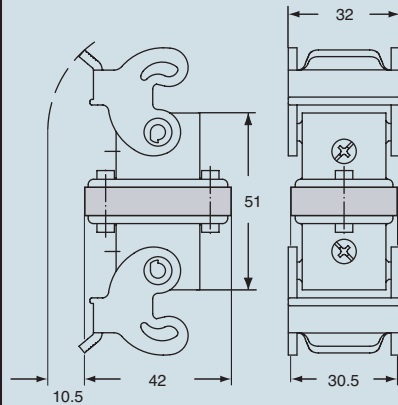

contacts side (front view)

side with reference arrow ▲

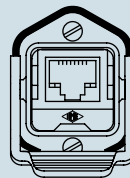

dimensions in mm

CYG 8 JFA, CYG 8/2 JFA

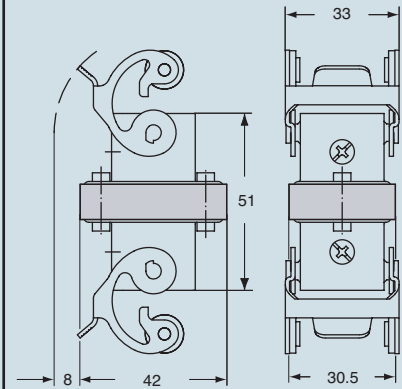

contacts side (front view)

side with reference arrow ▲

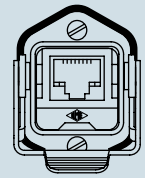

dimensions indicated are not binding and may be changed without notice

Connectors compliant with DESINA® standard

DESINA® (which stands for **DE**centralised and **Standardised INst**allation technology) is an innovative installation concept behind a study headed by the German manufacturers of machine tools association (VDW), with the co-operation of users (including German automotive manufacturers) and component manufacturers, which has led to the introduction of a specification aimed to standardise electrical, hydraulic and pneumatic components and their interconnection on common platform for CNC controlled machine tools and manufacturing lines.

In the last few years, the DESINA® specification has been successfully enclosed in the ISO TC 184/SC 1 "Industrial automation systems and integration / Physical device control" as an ISO standard. This work has recently been completed, and the following standards have now become available:

ISO 23570-1 Industrial automation systems and integration – Distributed installation in industrial applications: Part 1 – Sensors and actuators

ISO 23570-2 Industrial automation systems and integration – Distributed installation in industrial applications: Part 2 – Hybrid communication bus

ISO 23570-3 Industrial automation systems and integration – Distributed installation in industrial applications: Part 3 – Power distribution bus

Normally, production systems are controlled by various field buses available on the market such as PROFIBUS, CAN, INTERBUS, etc. DESINA® decentralised approach and interface and connector standardisation, which allows a single distributed control system to be independent from the bus communication protocol selected by the final user, ensure lower installation costs.

The availability of diagnostic capabilities in all the system components ensures a speedier diagnosis in the event of faults and an easier and quicker reset operation, which may be carried out by less specialised staff. DESINA® connection topology requires a **control bus** and a **power bus**.

The hybrid (optical/electrical) control bus provides a serial connection for the devices by using a cable consisting of two fibre optics and four power lines. The devices are fitted with 2 hybrid connectors (and matching flush mounted enclosures) for bus entry and exit. The hybrid connectors include an interface circuit which turns the TX electrical signal to optical signal with TTL levels and the RX signal from optical to electrical signal with TTL levels.

In other words, the interface is independent from the selected field bus protocol, and simply converts the electrical signals into optical signals and vice versa; by doing so, the physical connection between the devices can be used for different bus protocols and can reach a 50m range by using POF plastic fibres or 300m by using HCS® fibreglass (Hard Clad Silica – Spectran Corporation registered trademark). The highest baud rate is 12 Mbit/s, compatible with the most advanced field buses.

Another variance is also available, which is based on transmitting data on a pair of screened copper cables (instead of fibre optics); in this case, however, the system can only be used for PROFIBUS or CAN buses with RS 485 TX signals.

In both cases, the connector is fitted with housings for 5, 10A auxiliary contacts (CD series crimp contacts), which allow all connected devices to receive a permanent direct voltage of 24V (to supply circuits) and a 24V non permanent power supply (only used to open the contactors after operating an emergency switch or a safety switch), as well as a contact available for an optional earth.

The **power bus** provides a serial connection for drives, controls and power supplies and, more specifically, is suitable to supply power to motors and to their control units.

The standard connector to control motors is the **CQM/F 08** which, with 8 poles + ⊕ 16A 500V, and CC series crimp contacts, not only provides a power connection, but also connects the motor brake and safety thermistor.

Another variant is available in the same sizes as the enclosure: **CQM/F 04/2** featuring 4 poles + ⊕ 40A 400/690V and 2, 10A 250V auxiliaries.

For the motor side connection, the connector **CNEM/F 10** (10P + ⊕ 16A 500V 6kV 3, with screw terminals) should be used; with the option to make a star or a delta connection on the connector, the **CSSM/F 10** connector (10P + ⊕ 16A 500V 6kV 3, with spring terminals, two per pole) should be used. ILME connectors are manufactured to DESINA® specifications and in compliance with ISO 23570-2 and 23570-3 standards.



ISO 23570-3 standard and
DESINA® specification compliant

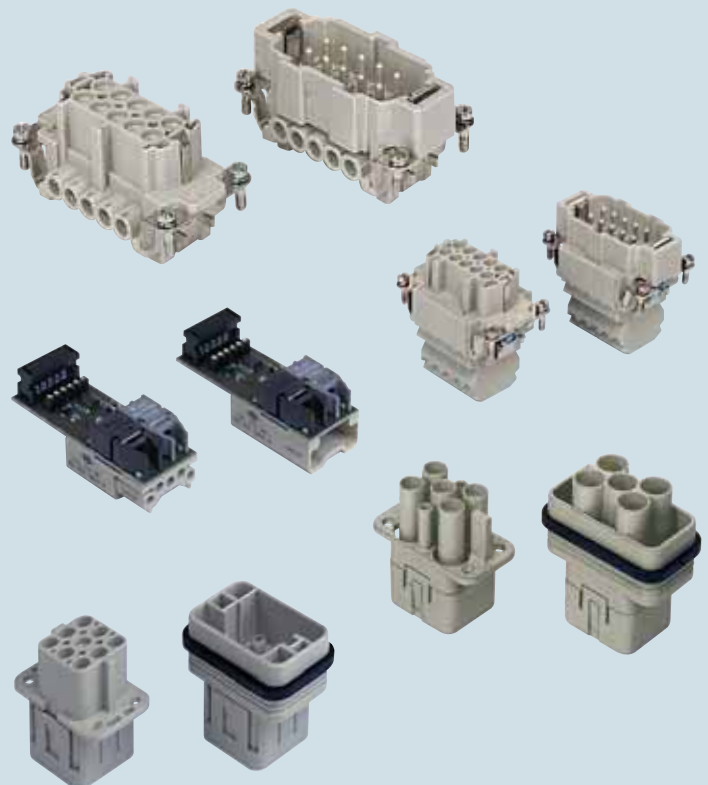

Hybrid socket and plug connectors for field buses compliant with DESINA® specifications and with ISO 23570-2 standard

The hybrid connectors for field buses are listed below:

- optical field bus plug	electrical auxiliary female contacts CXL 2/4 PF (for plastic fibre optics POF) CXL 2/4 PFH (for glass fibre optics HCS®)	electrical auxiliary male contacts CXL 2/4 PM (for plastic fibre optics POF) CXL 2/4 PMH (for glass fibre optics HCS®)
- optical field bus socket	CXL 2/4 SF	CXL 2/4 SM

The hybrid inserts for **socket** type optical field buses can only be fitted inside **fixed enclosures**.
The **plug** types, on the other hand, can only be fitted inside **portable enclosures**.

The enclosures and matching accessories available are listed below:

Construction details	Material	
- fixed, flush mounted enclosure:	PLASTIC CK 03 IN	METAL CKAX 03 I
- portable, straight enclosures:	CKG 03 VN (Pg 11) MKG VN20 (M 20)	CKAG 03 V (Pg 11) MKAG V20 (M 20)
- portable, angled enclosures:	CKG 03 VAN (Pg 11) MKG VAN20 (M 20)	CKAG 03 VA (Pg 11) MKAG VA20 (M 20)
- cover:	CKG 03 CN	CKAG 03 C

The portable enclosures and the covers are fitted with an additional seal in order to achieve **IP65/IP67** (IEC/EN 60529) protection rating. With these accessories, the enclosures achieve **IP69K** protection rating (tightness to pressurised hot water jets) established by the German standard DIN 40050-9 for use on board of road vehicles, currently being approved to be included in ISO standards and being studied by IEC.

1 Specifications

1.1 Interface

hybrid electrical-optical connector insert consisting of 2 connectors for fibre optics and 4 contacts for electrical wires; an interface circuit built into the optical socket converts the electrical signals into optical signals and vice versa.

1.2 Optical parts

transmitter (T): Agilent (HP) Versatile Link HFBR-1525, or equivalent
 receiver (R): Agilent (HP) Versatile Link HFBR-2525, or equivalent
 male optical contact: Agilent (HP) Versatile Link HFBR-4531, or equivalent, Simplex snap-in type (without crimping) for POF plastic fibre optics; HFBR-4521, or equivalent, crimp contact, for HCS® glass fibre optics
 note: POF is a plastic fibre optic with a 1000 µm diameter for red light and wavelength = 660 nm.
 HCS® is a Hard Clad Silica glass fibre optic with a 200 µm diameter for red light with wavelength = 660 nm.
 Optical parts: laser class I

1.3 Electrical contacts

4 maximum current 10A, gold or silver plated brass crimp contacts, cable section 0.14...2.5 mm² (CD series); live wire end female. Nominal voltage 24V.

Electrical data in compliance with EN 61984: **10A 25V 0.8kV 3**

1.4 Protection ratings

IP65 / IP67 compliant with EN 60529 (if a cable clamp with IP67 protection rating is used)
 IP69K compliant with DIN 40050-9 (with suitable cable clamp)

1.5 Temperature range

-40 °C / +70 °C

1.6 Data transmission/reception rate (Data rate)

up to 12 Mbit/s

2 Designation of auxiliary electrical contacts

designation of auxiliary electrical contacts (male and female) in the hybrid socket connector with optical TX system:

Socket connector with male auxiliary electrical contacts CXL 2/4 SM

Pos.	Function
1:	+ 24V not switched
2:	0V (reference for contact 1)
3:	0V (reference for contact 4)
4:	+ 24V switched

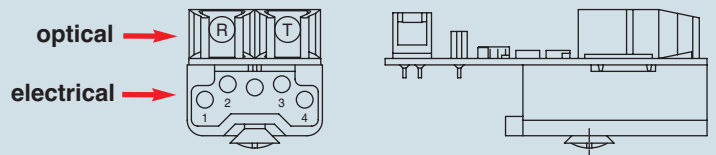

Socket connector with female auxiliary electrical contacts CXL 2/4 SF

Pos.	Function
1:	+ 24V not switched
2:	0V (reference for contact 1)
3:	0V (reference for contact 4)
4:	+ 24V switched

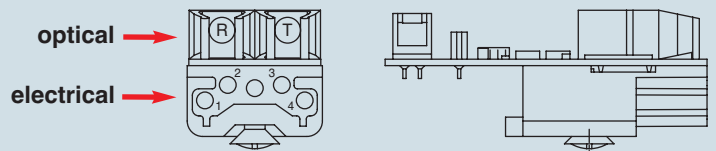

Insulation displacement connector (IDC) for ribbon flat cable on printed circuit

Pos.	Function	Pos.	Function
1:	earth	6:	TXD
2:	RXD	7:	earth
3:	RXD	8:	+5V DC
4:	earth	9:	+5V DC
5:	TXD	10:	earth

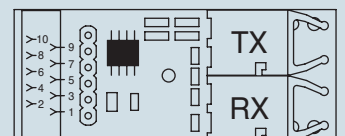

The contacts in the hybrid socket connector are numbered in a clockwise direction. With reference to this, the contacts in the field bus hybrid plug connector are numbered anticlockwise.

“R” Data reception (beam exit)
 “T” Data transmission (beam entry)

Socket and plug connectors for power buses compliant with DESINA® specifications and with ISO 23570-3 standard

The connector inserts on the power bus for a motor controller are as follows:

- **CQM 08** plug
- **CQF 08** socket

The connector inserts for the motor controller may be fitted inside the following enclosures:

Construction details	Material
	PLASTIC
- flush mounted fixed enclosure:	CQ 08 I
- portable straight enclosure:	CQ 08 V (Pg 21)
- portable angled enclosure:	CQ 08 VA (Pg 16)
- socket cover:	CQ 08 C
- plug cover:	CQ 08 CA

The enclosures ensure **IP65/IP67** protection rating (IEC/EN 60529) as well as **IP69K** protection rating (tightness to pressurised hot water jets) required by the DIN 40050-9 German standard for use on board of road vehicles, currently being approved as ISO standard and being studied by IEC.

1 Specifications

1.1 Connection

9 contacts (8 +⊕)

The male connectors (plugs) are used for termination of connecting cables; the female connectors (sockets) are fitted on the motor controller.

1.2 Electrical contacts

9 maximum current 10A, gold or silver plated crimp contacts, cable section 0.5...2.5 mm² (20 AWG -14 AWG) CC series.

1.3 Protection ratings

IP65 / IP67 compliant with EN 60529 standard (if a cable clamp with IP67 protection rating is used)

IP69K compliant with DIN 40050-9 standard (with suitable cable clamp)

1.4 Temperature range

-40 °C / +125 °C

1.5 Electrical data

compliant with EN 61984: **16A 500V 6kV 3**

1.6 Self extinguishing properties

94V-0 compliant with UL 94 standard

glow-wire 960 °C compliant with IEC/EN 60695-2-11 standard

2 Designation of contacts

The designation of contacts for motor controller outlet is as follows:

contact	designation
1	live L1
2	
3	live L3
4	brake (0 V)
5	temperature sensor
6	brake (+24V c.c.)
7	live L2
8	temperature sensor
PE	earth

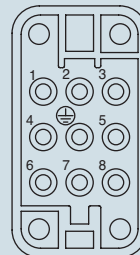
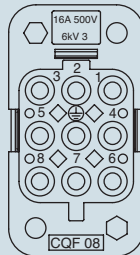

Socket and plug connectors for power buses in compliance with DESINA® specifications and with ISO 23570-3 standard

The connector inserts on the power bus for a motor controller are as follows:

- **CQM 04/2** plug
- **CQF 04/2** socket

These connector inserts can be fitted inside the following enclosures:

Construction details	Material
	PLASTIC
- flush mounted fixed enclosure:	CQ 08 I
- portable straight enclosure:	CQ 08 V (Pg 21)
- portable angled enclosure:	CQ 08 VA (Pg 16)
- socket cover:	CQ 08 C
- plug cover:	CQ 08 CA

The enclosures ensure **IP65/IP67** protection ratings (IEC/EN 60529) as well as **IP69K** protection rating (tightness to pressurised hot water jets) required by DIN 40050-9 German standard for use on board of road vehicles, currently being approved as ISO standard and being studied by IEC.

1 Specifications

1.1 Connection

5 (4 +⊕) power contacts + 2 auxiliary contacts

The male connectors (plugs) are used for termination of connecting cables; the female connectors (sockets) are fitted on the motor controller.

1.2 Electrical contacts

5 maximum current 40A (3P+N+⊕) gold or silver plated crimp contacts, cable section 1.5...6 mm² (16 AWG -10 AWG) CX series.

2 maximum current 10A, gold or silver plated crimp contacts, cable section 0.14...2.5 mm² (26 AWG -14 AWG) CD series.

1.3 Protection ratings

IP65 / IP67 compliant with standard EN 60529 (if a cable clamp with IP67 protection rating is used)

IP69K compliant with DIN 40050-9 standard (with suitable cable clamp)

1.4 Temperature range

-40 °C / +125 °C

1.5 Electrical data

compliant with EN 61984: **16A 500V 6kV 3**

1.6 Self-extinguishing properties

94V-0 compliant with UL 94 standard
glow-wire 960 °C compliant with IEC/EN 60695-2-11 standard

2 Designation of contacts

The designated of contacts for motor controller outlet is as follows:

contact	designation
1	live L1
2	live L2
3	live L3
4	neutral
PE	earth
11	aux
12	aux

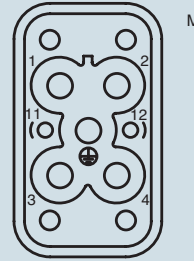
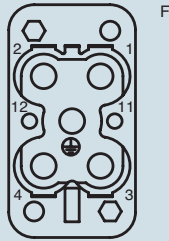
**Socket and plug connectors for power buses compliant with DESINA® specifications and with ISO 23570-3 standard**

The connector inserts on the power bus for motor controller are as follows:

	screw type	spring type
- plug	with cover CNEM 10 T	dual terminal for pole CSSM 10
- socket	CNEF 10 T	CSSF 10

To be installed in the enclosures illustrated in this catalogue or equivalent, with single lever (directed towards the motor)

The enclosures ensure **IP65/IP67** protection rating (IEC/EN 60529) as well as **IP69K** protection rating (tightness to pressurised hot water jets) required by the DIN 40050-9 German standard for use on board of road vehicles, currently being approved as ISO standard and being studied by IEC.

1 Specifications**1.1 Connection**

10 contacts +⊕

1.2 Electrical contacts

10 screw type contacts (CNE series) or spring type (CSS series), maximum current 16A, silver plated, wire section 0.5...2.5 mm² (20 AWG -14 AWG)

1.3 Protection rating

IP65 / IP67 compliant with EN 60529 standard (if a cable clamp with IP67 protection rating is used)
IP69K compliant with DIN 40050-9 standard (with suitable cable clamp)

1.4 Temperature range

-40 °C / +125 °C

1.5 Electrical data

in compliance with EN 61984: **16A 500V 6kV 3**

1.6 Self extinguishing properties

94V-0 compliant with UL 94 standard
glow-wire 960 °C compliant with IEC/EN 60695-2-11 standard

2 Designation of contacts

The designation of contacts for motor connector is as follows:

contact	designation
1	winding U1 - L1
2	winding V1 - L2
3	winding W1 - L3
4	brake (0 V)
5	brake (+24V cc)
6	winding W2
7	winding U2
8	winding V2
9	temperature sensor
10	temperature sensor
PE	earth

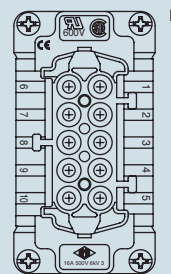
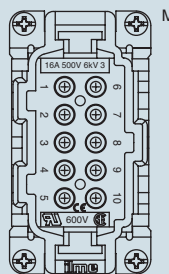

inserts series	No. of poles	auxiliary contacts	EN 61984 (2001-11) pollution rating 3			EN 61984 (2001-11) pollution rating 2			certification UL/CSA
			nominal voltage	pulsed holding nominal voltage	pollution rating	nominal voltage	pulsed holding nominal voltage	pollution rating	
code	main contacts		nominal voltage AC or DC						
CXL 2/4	2		contacts for plastic fibre optics (POF) Ø 1mm						50V
		4 (+⊕)	25V	0.8kV	3				
CXL 2/4...H	2		contacts for HCS® fibre optics ø 200 µm						50V
		4 (+⊕)	25V	0.8kV	3				
CQ 08	8 (+⊕)	---	500V	6kV	3	400/690V	6kV	2	600V
CQ 04/2	4	---	400/690V	6kV	3				600V
		2	250V	4kV	3				600V
CNE	10 (+⊕)	---	500V	6kV	3	400/690V	6kV	2	600V

Nominal Data

Nominal data complies with requirements of EN 61984 standard.

Marking example to be applied only in a mains power supply with insulated neutral or with neutral to earth in a corner (see Table 5, EN 61984):



Marking example to be applied in any mains power supplies, including those with insulated neutral and the delta power supplies with earth in a corner (see Table 5, EN 61984):



accessories

inserts series	max rated current ⁴⁾	contact resistance _{IV}	insulation resistance _{IV}	ambiance temperature limit (°C)		protection rating		wirer connection ⁵⁾					certifications ³⁾	
				min	max	with enclosures	without enclosures	screw	spring	connection block at 45°	crimp	snap-in		
CXL 2/4	---	---	---	-40	+70	IP65/IP67	IP20						✓	
	10A	3 mΩ	10 GΩ	-40	+70	IP65/IP67	IP20					✓		cUL ^{A)}
CXL 2/4...H	---	---	---	-40	+70	IP65/IP67	IP20						✓	
	10A	3 mΩ	10 GΩ	-40	+70	IP65/IP67	IP20					✓		cUL ^{A)}
CQ 08	16A	1 mΩ	10 GΩ	-40	+125	IP65/IP67	IP20					✓		cUL ^{A)}
CQ 04/2	40A	0.3 mΩ	10 GΩ	-40	+125	IP65/IP67	IP20					✓		cUL ^{A)}
	10A	3 mΩ	10 GΩ											
CNE	16A	1 mΩ	10 GΩ	-40	+125	IP65	IP20	✓						UL, CSA







1) See the insert load curves to establish the actual maximum operating current according to the ambient temperature

2) For the wire electrical connection data, see from page 18

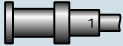
3) The certifications shown in brackets are being applied for.







A) UL for USA and Canada

10A max contacts - CD serie

conductor section (mm ²)	AWG	identification number
0.14 ÷ 0.37	26 ÷ 22	
0.5	20	
0.75	18	
1	18	
1.5	16	
2.5	14	

Contacts can be supplied in the silver or gold plated version

16A max contacts - CC serie

conductor section (mm ²)	AWG	throat identification
0.5	20	
0.75	18	
1	18	
1.5	16	
2.5	14	
4	12	

Contacts can be supplied in the silver or gold plated version

Male contacts can also be supplied in the "advanced" version (shortened contact)

40A max contacts - CX serie

conductor section (mm ²)	AWG	identification
1.5	16	hole Ø1.75 mm
2.5	14	hole Ø2.25 mm
4	12	hole Ø2.85 mm
6	10	hole 3.5 mm

Contacts are supplied in the silver plated version only



enclosures: **size "21.21"**
insulating typepage 288÷289
metallic typepage 290÷291

- data baud rate: up to 12 MBit/s
- temperature range: from -40 °C to +70 °C
- for crimp contacts, see the crimp tools section (10A contacts, CDF and CDM series) on pages 296, 300, 304, 306, 308



ISO 23570-3 standard and
 DESINA® specification compliant

inserts, crimp connections



**10A crimp contacts
 silver and gold plated**



description	part No.	part No.	part No.
inserts for fixed enclosures, complete with electro-optical interface* without contacts (to be ordered separately) socket inserts for female contacts plug inserts for male contacts	CXL 2/4 SF CXL 2/4 SM		
without electro-optical interface for fixed enclosures without contacts (to be ordered separately) socket inserts for female contacts plug inserts for male contacts	CXL SF CXL SM		
10A female contacts 0.14÷0.37 mm ² AWG 26÷22 identification No. 1 0.5 mm ² AWG 20 identification No. 2 0.75 mm ² AWG 18 identification No. ② 1 mm ² AWG 18 identification No. 3 1.5 mm ² AWG 16 identification No. 4 2.5 mm ² AWG 14 identification No. 5		CDFA 0.3 CDFA 0.5 CDFA 0.7 CDFA 1.0 CDFA 1.5 CDFA 2.5	CDFD 0.3 CDFD 0.5 CDFD 0.7 CDFD 1.0 CDFD 1.5 CDFD 2.5
10A male contacts 0.14÷0.37 mm ² AWG 26÷22 identification No. 1 0.5 mm ² AWG 20 identification No. 2 0.75 mm ² AWG 18 identification No. ② 1 mm ² AWG 18 identification No. 3 1.5 mm ² AWG 16 identification No. 4 2.5 mm ² AWG 14 identification No. 5		CDMA 0.3 CDMA 0.5 CDMA 0.7 CDMA 1.0 CDMA 1.5 CDMA 2.5	CDMD 0.3 CDMD 0.5 CDMD 0.7 CDMD 1.0 CDMD 1.5 CDMD 2.5

silver plated

gold plated

* fitted with IDC connector for TTL to bus connection
 ribbon cable

dimensions in mm

CXL 2/4 SM

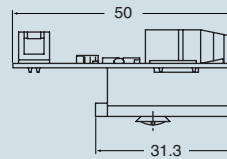
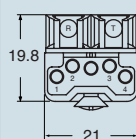

CXL 2/4 SF

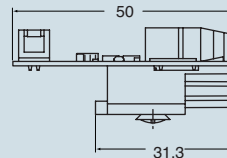
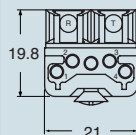

dimensions in mm

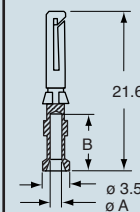
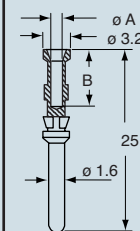

CDF and CDM contacts

conductor section mm ²	conductor slot ø A (mm)	B (mm)
0.14÷0.37	0.9	8
0.5	1.1	8
0.75	1.3	8
1.0	1.45	8
1.5	1.8	8
2.5	2.2	6

- stripping length see section feature of inserts
 on page 13

dimensions indicated are not binding
 and may be changed without notice

accessories



enclosures: **size "21.21"**
insulating typepage 288÷289
metallic typepage 290÷291

- temperature range: from -40°C to +70°C
 - for crimp contacts, see the crimp tools section (10A contacts, CDF and CDM series) on pages 296, 300, 304, 306, 308



ISO 23570-3 standard and DESINA® specification compliant

inserts, snap-in (POF) or crimp (HCS®) optical connection electrical crimp connection



10A crimp contacts silver and gold plated



description	part No.	part No.	part No.
inserts for portable enclosures with: 4 + 1 crimp 1.5mm ² contacts (included) + 2 snap on contacts for 1mm ¹ plastic (POF) fibre optics socket inserts with CDFA 1.5 female contacts plug inserts with CDMA 1.5 male contacts	CXL 2/4 PF CXL 2/4 PM		
inserts for portable enclosures with: 4 + 1 crimp 1.5mm ² contacts (included) + 2 crimp contacts for 0.2mm ² HCS® fibre optics socket inserts with CDFA 1.5 female contacts plug inserts with CDMA 1.5 male contacts	CXL 2/4 PFH CXL 2/4 PMH		
inserts for portable enclosures with: 4 + 1 crimp contacts (not included – CDF and CDM series) + 2 snap on or HCS® fibre optic contacts (not included) ³⁾ socket inserts with female contacts plug inserts with male contacts	CXL PF CXL PM		
10A female contacts 0.14÷0.37 mm ² AWG 26÷22 identification No. 1 0.5 mm ² AWG 20 identification No. 2 0.75 mm ² AWG 18 identification No. ② 1 mm ² AWG 18 identification No. 3 1.5 mm ² AWG 16 identification No. 4 2.5 mm ² AWG 14 identification No. 5		CDFA 0.3 CDFA 0.5 CDFA 0.7 CDFA 1.0 CDFA 1.5 CDFA 2.5	silver plated CDFD 0.3 CDFD 0.5 CDFD 0.7 CDFD 1.0 CDFD 1.5 CDFD 2.5
10A male contacts 0.14÷0.37 mm ² AWG 26÷22 identification No. 1 0.5 mm ² AWG 20 identification No. 2 0.75 mm ² AWG 18 identification No. ② 1 mm ² AWG 18 identification No. 3 1.5 mm ² AWG 16 identification No. 4 2.5 mm ² AWG 14 identification No. 5		CDMA 0.3 CDMA 0.5 CDMA 0.7 CDMA 1.0 CDMA 1.5 CDMA 2.5	gold plated CDMD 0.3 CDMD 0.5 CDMD 0.7 CDMD 1.0 CDMD 1.5 CDMD 2.5

® HARD CLAD SILICA (SpecTran Corporation registered trademark)

¹⁾ for POF fibre preparation, the polishing kit Agilent HFBR-4593 (CXL POL) is available on request

²⁾ for HCS® connection preparation, the Crimp & Clear cabling kit (without glue or polishing kit) for simplex connectors for 200/300 μm HCS® fibre optics is available on request. The (CXL KCC) kit consists of:

- No. 1 scissors for kevlar cutting
- No. 1 cable stripper
- No. 1 fibre stripper
- No. 1 calibrated pliers
- No. 1 precision fibre optics cutter with diamond blade.

All accessories are stored in a hard carrying case

³⁾ see data on page 281

dimensions in mm

CXL 2/4 PM and PMH

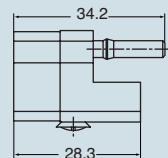
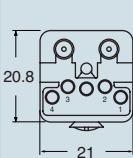

CXL 2/4 PF and PFH

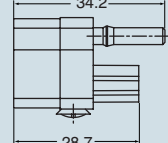
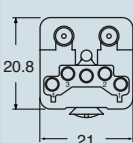

- 8 mm wire stripping
- POF 7 mm fibre stripping

dimensions in mm

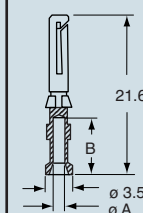
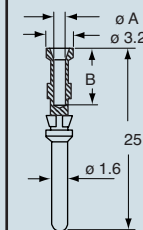

CDF and CDM contacts		
conductor section mm ²	conductor slot ø A (mm)	B (mm)
0.14÷0.37	0.9	8
0.5	1.1	8
0.75	1.3	8
1.0	1.45	8
1.5	1.8	8
2.5	2.2	6

- stripping length see section feature of inserts

dimensions indicated are not binding and may be changed without notice

accessories



inserts:

- CXL 2/4 SFpage 286
- CXL 2/4 SMpage 286
- CXL SFpage 286
- CXL SMpage 286

CJ KFpage 278

bulkhead housings



cover



description	part No.	part No.
with lever	CK 03 IN (black)	
with pegs and gasket		CKG 03 CN (black)

panel cut-out for enclosures, in mm

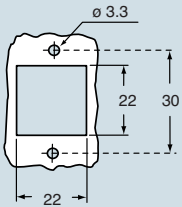

dimensions in mm

CK IN

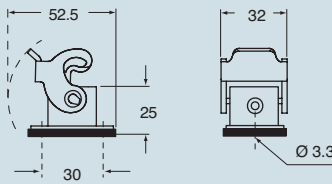

dimensions in mm

CKG CN

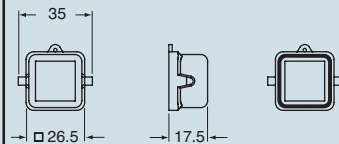

Note:
CXL and CJ K inserts are already supplied with seal and screw, which ensure IP66/IP67 protection rating.

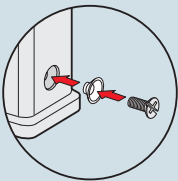

accessories

dimensions indicated are not binding and may be changed without notice

inserts:

- CXL 2/4 PFpage 287
- CXL 2/4 PFHpage 287
- CXL 2/4 PMpage 287
- CXL 2/4 PMHpage 287
- CXL PFpage 287
- CXL PMpage 287

CJ KMfrom page 278

hoods



description	part No. (entry - Pg 11)	part No. (entry - M 20)
with pegs and gasket, top entry	CKG 03 VN (black)	MKG VN20 (black)
with pegs and gasket, side entry	CKG 03 VAN (black)	MKG VAN20 (black)

Note:
CXL and CJ K inserts are already supplied with seal and screw, which ensure IP66/IP67 protection rating.

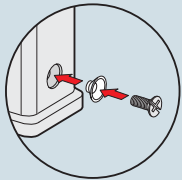

dimensions in mm

CKG VN and MKG VN

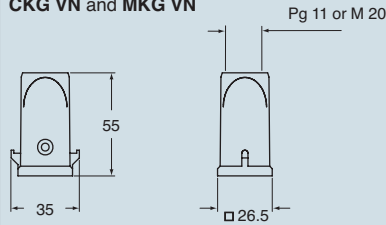

CKG VAN and MKG VAN

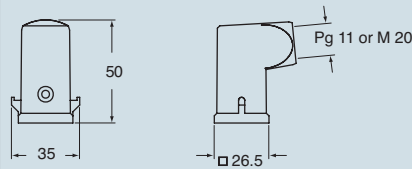

dimensions indicated are not binding
and may be changed without notice

inserts:

- CXL 2/4 SFpage 286
- CXL 2/4 SMpage 286
- CXL SFpage 286
- CXL SMpage 286

CJ KFpage 278

bulkhead housings



cover



description	part No.	part No.
with stainless steel lever	CKAX 03 I	
with pegs and gasket		CKAG 03 C

panel cut-out for enclosures, in mm

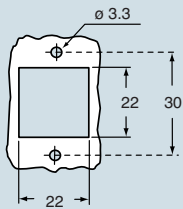

dimensions in mm

CKAX I

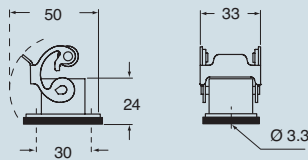

dimensions in mm

CKAG C

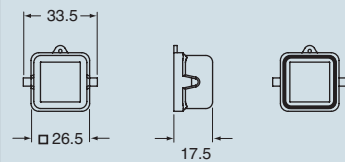

Note:
CXL and CJ K inserts are already supplied with seal and screw, which ensure IP66/IP67 protection rating.

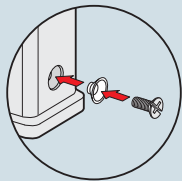

dimensions indicated are not binding
and may be changed without notice

inserts:

- CXL 2/4 PFpage 287
- CXL 2/4 PFHpage 287
- CXL 2/4 PMpage 287
- CXL 2/4 PMHpage 287
- CXL PFpage 287
- CXL PMpage 287

CJ KMpage 278

hoods



description	part No. (entry - Pg 11)	part No. (entry - M 20)
with pegs and gasket, top entry	CKAG 03 V	MKAG V20
with pegs and gasket, side entry	CKAG 03 VA	MKAG VA20

Note:
CXL and CJ K inserts are already supplied with seal and screw, which ensure IP66/IP67 protection rating.

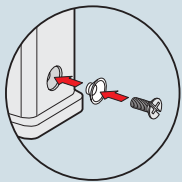

dimensions in mm

CKAG V and MKAG V

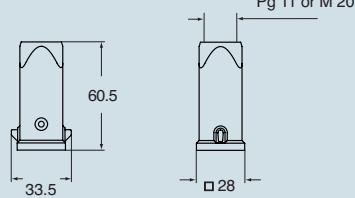

CKAG VA and MKAG VA

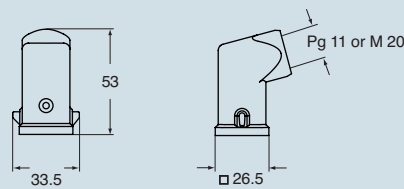

dimensions indicated are not binding
and may be changed without notice

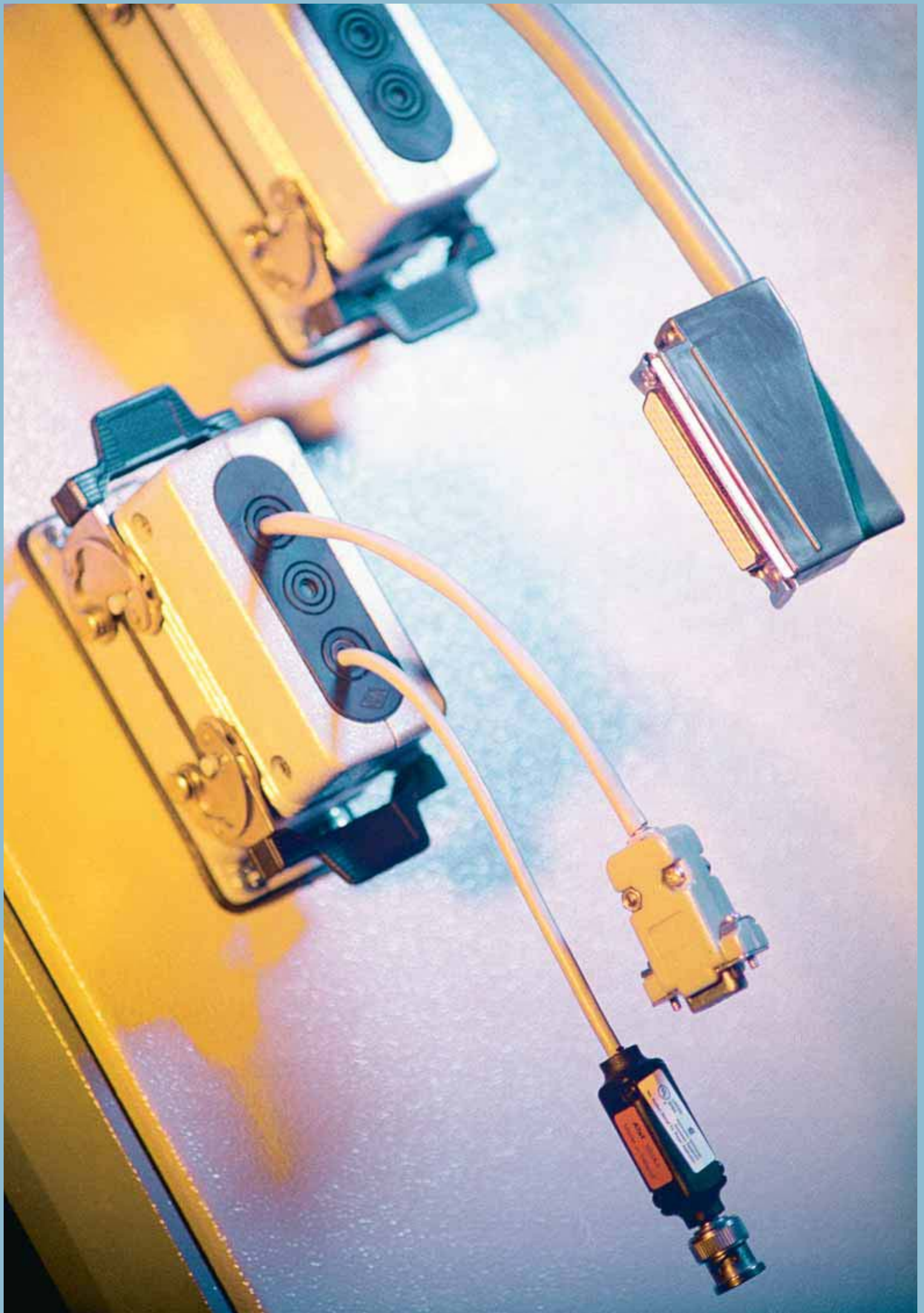

The crimping concept

The crimp connection is an irreversible connection between one or two conductors and a crimp contact. The crimp connection is obtained by pinching or pressing the contact metal - or shaft - firmly with the crimping tool.

A good crimp connection is provided by a suitable combination between the crimping base, the crimping part of the contact metal, i.e. the crimp contact, firmly with and the section of the conductor.

These comments refer to crimped connections carried out with copper flexible conductors in class 5 (flexible) or 6 (extra flexible) according to standards IEC 60228 and IEC 60228-A (Italian standard CEI 20-29).

Solid copper conductors (class 1) or in other materials (aluminium, iron, etc) often require special precautions for contacts and for crimping tools, to be agreed with the manufacturer.

The main technical advantages provided by crimping connections over soldered connections are:

- The process does not use heat and does not require materials.
- Perfect connection is acquired that is intrinsic with cold soldering.
- No degradation of the elastic characteristics of the female contacts (a problem that arises with soldering temperatures).
- No health risks connected with the use of heavy metals or fumes generated from the soldering process.
- Preservation of the conductor's flexibility immediately upon connection.
- No conductors with burned, discoloured or overheated insulating material.
- Excellent reproducibility of the performances of the electrical and mechanical connections.
- facilitated production controls.

Other advantages obtained by crimping connections over screw terminal connections are:

- Less drop of currency in the connector contacts.
- High stability in time even in the presence of vibrations.
- High duration in presence of corrosion (gastight).
- Individual insertion of the contacts in the connector (it is possible to eliminate unnecessary contacts).
- Less time required for connection.
- Possibility of pre-production of the terminated conductors with crimp contacts.
- Easy substitution of individual contacts during maintenance.
- Possibility of selectively isolating the circuits during maintenance via the extraction of the contacts from the connector.

The crimped connections for wire sections up to 10 mm² are covered by the EN 60352-2:2006 European standard equivalent to the IEC 60352-2 Issue 2 (2006-02) international standard.

The **EN 60352-2** standard also includes a practical guide, which lists the following main points.

The quality of a crimped connection is mainly affected by the quality of materials used and by the condition of the crimp contact (in particular the crimp shaft) and wire surfaces.

To ensure a good quality crimped connection, an essential parameter is the wire mechanical retention in the contact.

The standard makes a distinction between the closed crimp shaft, inherently stronger, and the open crimp shaft. ILME crimp contacts are closed crimp shaft contacts, with inspection hole which ensures a higher mechanical performance compared to the open shaft crimp contacts, such as better mechanical sturdiness and stability during operation.

They have been machine turned, thus ensuring a better electrical performance (better conductivity).

2002 Amendment 2 of the previous IEC standard issue controversially unified the minimum resistance to tensile stress values established for open shaft contacts (curve B of old Figure 5) and closed shaft contacts (curve A of old Figure 5) by lowering them to the values (shown in curve B), which can be achieved by open shaft crimp contacts. This has controversially relaxed the suitability requirements both for closed crimp shaft, typically large, machine turned and for crimp tools specially made for these contacts. Several industries continue to prefer the higher performance ensured by closed shaft crimp contacts, the only ones to ensure the higher resistance to tensile stress values believed to be essential for the most demanding industrial applications.

Therefore, ILME continues to refer to curve A of Figure 5 illustrated in the EN 60352-2 (1994) standard: ILME closed shaft crimp contacts, used with

flexible copper wires, featuring a section included in the ranges shown and correctly crimped with the recommended tools, ensure breakage resistant connections at least equal to the values shown in the table shown below (for reference, the corresponding R_f/S unified tensile stress load value is also shown [N/mm²]).

Section S		Resistance to traction R _t (N)	R _f /S (N/mm ²)
AWG	mm ²		
26	0.12	18	150
-	0.14	21	150
24	0.22	33	150
-	0.25	37.5	150
22	0.32	48	150
-	0.37	55.5	150
20	(0.6)	75	150
-	0.75	112.5	150
18	(0.82)	125	150
-	1	150	150
16	(1.3)	195	150
-	1.5	220	147
14	(2.1)	300	143
-	2.5	325	130
12	(3.3)	430	130
-	4	500	125
10	(5.3)	635	120
-	6	650	108
7	10	1000 <i>(1300)</i>	100 <i>(130)</i>
-	16	<i>1650</i>	<i>103</i>
-	25	<i>2300</i>	<i>92</i>
-	35	<i>2800</i>	<i>80</i>
-	50	<i>3300</i>	<i>66</i>
-	70	<i>3900</i>	<i>56</i>

NOTE - For 10 mm² wire sections, the resistance to tensile stress shown in *italics* are those specified in the NF F 61-030 standard (for 10 mm², the value in brackets)

The basic criteria used for the resistance to tensile stress values required by EN 60352-2 standard is that such resistance is at least equal to 60% of the breakage unified load of the same annealed copper wire.

This applies to wire sections up to about 1.5 mm²; above this section, the ratio is slightly lower as retention is also affected by friction, which increases linearly with the housing diameter, whilst the section increases by the square.

IEC/EN 60352-2 standard, which targets the electronics industry, restricts its requirements to crimp connections for wires with a maximum section of 10 mm². For sections higher than 10 mm², up to 70 mm², the standard to refer to is the NF F 61-030 (1989) French standard which relates to electrical connectors to be used on board of railway rolling stock, in particular for large crimp contacts, such as those manufactured by ILME.

NOTE - Alternatively, for wire sections between 35 mm² and 300 mm², EN 61238-1:2003 standard can be referred to. This standard requires constant R_f/S values equal to 60 N/mm², lower than those established by the above mentioned French standard.

Selecting the crimping tool and relevant controls

When you have selected quality crimp contacts and conductors, the next step and most important step is to select the correct work tool. The practical guide of standard EN 60352-2 provides the following recommendations on the subject. They list some of the ideal requirements for crimping tools, some optional characteristics, but, above all, they provide a preview of the indispensable controls:

- a) The crimping tools and the contacts used must be supplied by the same manufacturer, otherwise the user must assume all responsibility for the quality and reliability of the crimp connections.
- b) The crimping tools must function correctly and provide a correct crimp without damage to the pin or the component to crimp.
- c) In order to obtain a reliable crimp connection, a crimping device with a mechanism that controls the entire crimping cycle must be used. At the end of the crimping cycle the handles and the ratchet must return to the open position.
- d) In all cases the crimping operation must be made in one single phase, with no further interventions.
- e) The removable parts of the tool such as the crimping dies and the locators must be designed in such a way as to make it possible to be inserted within the tool only in the correct manner.
- f) The tools must be supplied with the appropriate means for a correct positioning of the pins to be crimped and of the conductors during crimping.
- g) The tools must be designed in such a way so that only the necessary adjustments may be made.
- h) The action of the tool must be such that both the pin to be crimped and the fixture of the isolation (when present) are respectively crimped or compressed with a single action.
- i) The design of the tool must ensure that the dies for a particular tool may be interchangeable within tools of the same type. If they are not interchangeable, the identification of tools for which they are suitable must be marked on the dies.
- j) The tools may be designed so as to produce a marking or coding of the die on the pin to be crimped so that the crimping may be checked for verification of the correct die.
- k) The design of the tool must allow the verification of the dies with gauges to measure wear. The gauge verification method must be that specified by the manufacturer of the tools.

With suitable flexible copper conductors, the crimping tool proposed by ILME gives 8 impression crimp (see figure) in conformity with standard EN 60352-2.

Periodic control of the wear of the crimping matrixes can be carried out with the appropriate "go - no go" gauges (purchased separately). For extra operational details, consult the following pages on tools, and the relevant instruction sheets and/or use and maintenance manuals.

The manual and automatic crimping tools selected by ILME are carefully designed to ensure symmetrical deformation of the crimping area of the contact and wire, by means of their own, internal high pressure forming parts. The positioner ensures that the wire and crimp contact meet in the appropriate part of the tool. Sprung mechanisms built into the tools ensure that the contacts are not inserted in the tool before the indenters are fully open, and that the tool does not open before the crimping process has been completed.

The **CCPZ MIL** (for 10A and 16A crimp contacts) and **CXPZ D** (for 40A crimp contacts) manual crimping tools are suitable for use when compressed air sources are unavailable, for low or medium-low work loads. The **CCPZ RN** (for 10A, 16A and 40A crimp contacts) manual crimping tool is also suitable for low or medium-low work loads.

The **CCPZP** pneumatic crimping bench tool without automatic positioner (for 10A and 16A crimp contacts) is suitable for use in the workshop (where compressed air is available) for high or medium-high work loads. Using the same manual crimping tool turrets it is possible to change rapidly from crimping on male contacts to crimping on female contacts of the same series (10A and 16A).

The **CCPZPA** pneumatic crimping bench tool with automatic positioner (for 10A and 16A crimp contacts) is suitable for workshop jobs (where compressed air is available) for medium-high or high work loads. It is recommended in particular for crimping high quantities of contacts that are the same type or have the same section, thus saving a significant amount of time thanks to automatic operation and reduced operator fatigue. Where the type or kind of contact must be changed frequently, it is preferred to use the version without automatic positioner.

The **CXPZP D** pneumatic crimping bench tool without automatic positioner (for 40A crimp contacts) is suitable for use in the workshop (where compressed air is available) for high or medium-high work loads. By using the same positioners as those of manual crimper CXPZ D, the size of a contact can be rapidly changed with one of the same type. However, the positioner must be changed in order to change over from male to female contacts.

In any case, the quality of the results from the crimping tools, combined with the ILME crimp contacts, is identical and at the highest market levels, exceeding the requirements of the standard EN 60352-2.

Although the crimping appliances and tools suggested here include a set of control automatisms and mechanisms, which prevent the chief misunderstandings and errors, the operator is advised to always take care not to work in inappropriate conditions.

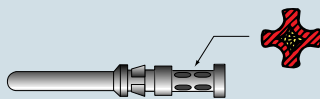

The crimping operation

The practical guide in standard EN 60352-2 supplies further general information regarding crimp contacts for multipole connectors.

1. Insertion of the conductor in the crimp contacts

The conductor must be correctly positioned in the pin to be crimped. The crimping indentations must be correctly positioned on the foot to be crimped. There must be sufficient space, in conformity with the manufacturer's instructions, between the end of the insulating material of the conductor and the pin to be crimped ("d"). As a general rule, the stripping length is equal to the pin insertion depth + 1 mm (for sections up to 1 mm²) and + 2 mm (for sections from 1 to 10 mm²). When using closed crimp pins with an inspection hole, the crimp conductor must be visible through the inspection holes.

* Keeping the conductor strands visible above the contact collar enables you to check correct stripping, i.e. make sure no strands have been cut. This also ensures a certain flexibility for the connection, by not transmitting to the contact any flexure stresses caused by installation. However, in practice, some operators give priority to insulation, by reducing to zero the gap between cable insulation and the contact collar.

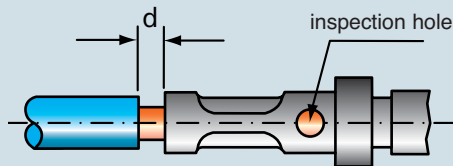

2. Insertion of crimped contacts in the connector insert

It is recommended that the crimped contacts be perfectly straight and inserted within the contact slots in a single operation and without excessive force until a clicking sound is heard. The correct retention of the contact should be verified with a light pulling of the wire. Non alignment of the crimped contacts must be avoided because this could cause possible loosening of the retention springs and consequently jeopardise the retention of the contact in the insert. For small section conductors ($\leq 0.35 \text{ mm}^2$) or for specific application, the use of the insertion tool specified by the manufacturer is recommended.

3. Removal of inserted contacts

In the case of incorrect insertion or wiring substitution, inserted contacts may only be removed using the removal tools specified by the manufacturer.

4. Mounting and flexure of multiwired bundles or multipolar cables with crimp contacts

Bundles of conductors or multipolar cables with crimp contacts for multipole connectors must not cause stress to the inserted contacts with their weight as this would cause the contacts to bend over to the coupling area of the connectors and consequently damage them. The connectors must therefore be provided with cable clamps or the conductor bundles or multipolar cables must be mounted as described in the figures herebelow.

Multipolar cable

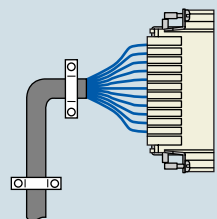

Conductor cables

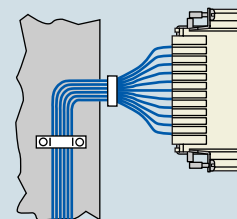

If the conductor bundles or the multipolar cables have to be immediately folded over on the back of the connector insert, it is recommended not to use any mechanical force in the axial direction with respect to the coupled contacts. The figure herebelow shows a correct bending and clamping of the multiwire bundles using the crimp contacts.

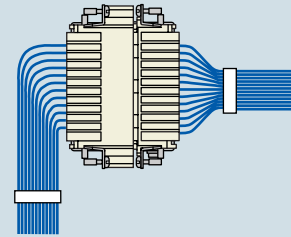

5. Coupling and uncoupling of multipolar connectors with crimp contacts

In order to prevent stress on the crimp contacts, the connectors must be coupled and uncoupled in the axial direction with respect to the contacts, without touching the conductor bundles or cables. Standard DIN 43652 (incorporated into specification EN 175301-801) that applies to the ILME inserts of the CD series (this recommendation is also valid for the CDD series) prescribes a maximum deflection from the axis of $\pm 5^\circ$ on the greater side and $\pm 2^\circ$ on the smaller side.

correct

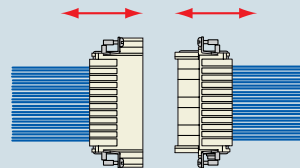

incorrect

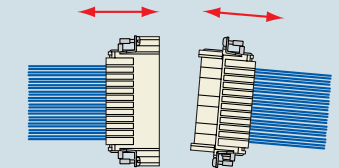

To keep the play within this limit, especially during the uncoupling phase, guide pins CRM and CRF may be used. The use of ILME pliers (code number CPES) is recommended for the uncoupling operations for CD inserts (64 poles) and CDD inserts (108 poles). The pliers work on the fulcrum and lever principle and perform the following main tasks:

- I - Reduce effort and coupling times to the minimum, even when working in the most impractical and inaccessible points;
- II - Perform the uncoupling of multipolar connectors in full conformity of standard DIN 43652 (now EN 175301-801).

The pliers allow the extraction of the inserts to be made perfectly axially with respect to the contacts, evenly distributing the pressure on four points (housing pins).

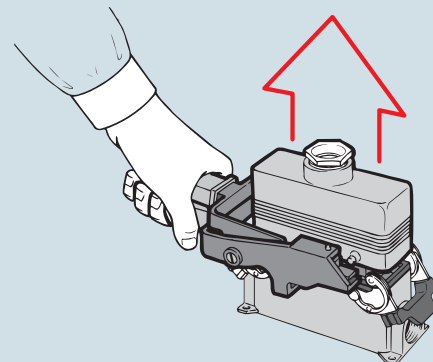

for contacts of insert series:	page
CD (10A)	39÷47
CDD (10A)	53÷60
CDC (16A)	67÷71
CQ (16A)	63÷64
CQE (16A)	74÷79
CCE (16A)	86÷96
CMCE (16A)	114÷125
CX 8/24 (16A/10A)	129
CX 6/36 (10A)	130
CX 12/2 (10A)	131
MIXO (16A/10A)	140÷148

* the underlined polarities indicate those contacts that require the tools shown in this page

**manual crimping tool
turret heads - gauge**



**insertion tool
removal tools - tip**



description	part No.	part No.
crimping tool for 10A and 16A contacts DANIELS AF8 model (turret excluded)	CCPZ MIL	
turret heads (see note) - for 10A contacts (CDF and CDM series) - for 16A contacts (CCF and CCM series)	CCTP 10 CCTP 16	
"go / no go" control gauge to verify indenter closure (see note)	CCPNP	
insertion tool for insertion of the contacts into the inserts for crimped contacts up to 0.75 mm ²		CCINA
removal tools for the extraction of contacts from the inserts - for 10A contacts ¹⁾ - for 16A contacts ²⁾		CCES CQES
replacement tip for CCES removal tool		CCPR

Notes:

- 1) for CD, CDD, CX inserts (10A auxiliary contacts) and MIXO module (10A)
- 2) for CQ, CQE, CCE, CMCE inserts (excluded 16+2) and MIXO module (16A) for CDC, CMCE (16+2), CX inserts (contacts 16A insert CX 8/24) using a flat 3 mm screwdriver.

Positioning turret

conforms to international standard MIL-C-22520/1
- An interchangeable and indispensable accessory of the CCPZ MIL crimping tool, it precisely positions the contact where crimping is performed. Each series of contacts requires its own turret.

"go / no go" control gauge

conforms with international standard MIL-C-22520/3
- A tool used to periodically check that the crimping tool meets standard requirements.

CCPNP

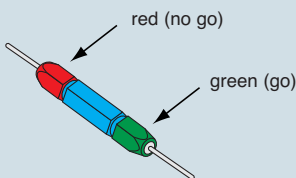

CCPZ MIL

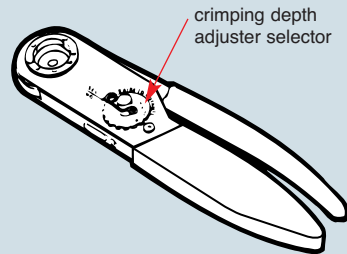

CCTP

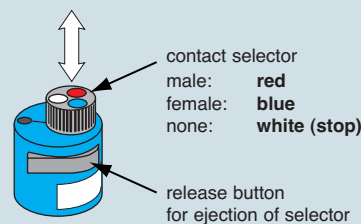

CCINA

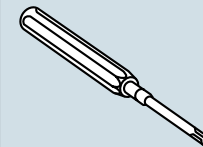

CCES

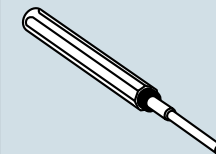

CCPR RN

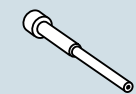

CQES

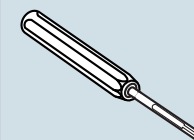

crimping tools

General specifications

The CCPZ MIL crimping tool conforms to the international standard MIL-C-22520/1. Crimping is performed with 8 pressure points. The tool is equipped with a geared mechanism to control the complete crimping cycle.

The tool must be equipped with an interchangeable turret (CCTP) according to the series of contacts to be crimped.

Crimping range

Wire section: dimension from 0.12 mm² (26 AWG) to 4 mm² (12 AWG).

Caution!

The handle of the tool must be in the open position when the turret is installed, disassembled or opened. If not, the turret and the crimping tool may be damaged.

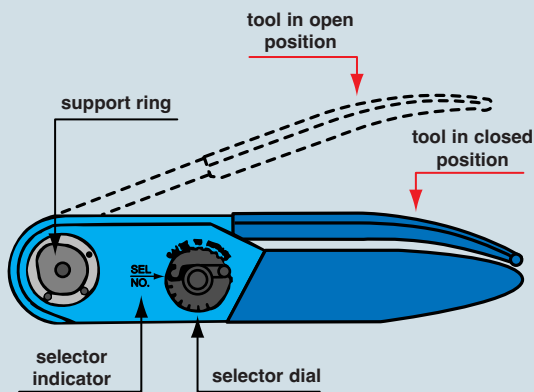

CCTP turret installation

1. The crimping tool must be in the open position.
2. Press the clicking lever that releases the turret in the adjustment position.
3. Position the previously selected CCTP turret on the support ring located on the crimping tool (matching the special pin on the base of the turret with the corresponding hole on the support ring), aligning the tapped holes with the socket head screws.
4. With the CCTP turret positioned against the support ring, tighten the socket head screws with the 3.5 mm Allen wrench (supplied with the kit).
5. Refer to the data plate on the CCTP turret. From the colour code column, select the colour of the positioner that corresponds to the appropriate code and dimension of the contact to be crimped.
6. With the CCTP turret in the adjustment position, turn the turret until the colour-coded positioner is aligned with the indicator line. Press the turret until it clicks into the connected position.
7. Refer to the data plate on the CCTP turret. From the column indicating the proper conductor section, determine the number that corresponds to the contact being used.
8. Remove the retaining hook from the crimping tool selector dial. Lift the selector dial and turn it until the selector number is aligned with the indicator (SEL.NO.). Replace the retaining hook (if necessary).

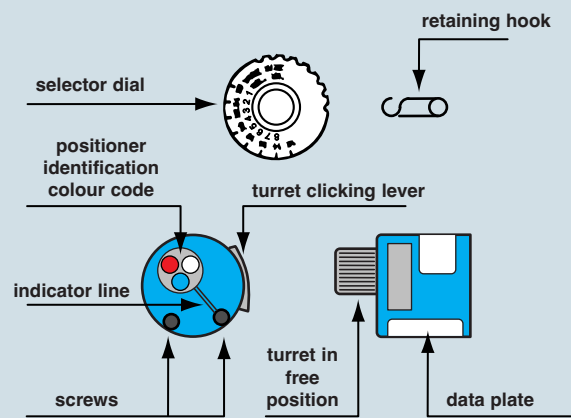

Crimping instructions

1. Insert the contact and the prepared conductor through the opening of the indenter in the turret positioner.
2. Tighten the crimping tool handle until the stop gear is released. The tool will return to the open position.
3. Check the position of the crimping on the contact crimping foot. Ideally, the crimping should be between the inspection hole and the top edge of the crimping foot. The head of the contact should not be squared and the inspection hole should be intact.

Crimping tool maintenance

No maintenance is required. However, it is good practice to keep the indenter tips free from residual deposits of the coloured band (some types of crimp contacts as per MIL standards are identified by coloured bands in the crimping area) and any other debris. A metal brush may be used for this purpose. The following is strongly recommended:

1. DO NOT immerse the tools in a solution to clean them.
2. DO NOT brush oil in the tools to lubricate them.
3. DO NOT try to disassemble the tool or repair it.

This is a high-precision manual crimping tool and must be used as such. For automatic crimping operations refer to the CCPZP and/or CCPZPA crimping tool models.

Removing the CCTP turret

With the crimping tool in the open position, to disassemble the turret, loosen the socket head screws using the 3.5 mm Allen wrench (supplied with the kit). After the threads are released from the support ring, pull off the turret with a straight movement.

Instructions to check calibration

The operations to check the crimping tool must be carried out with the selector dial in position 4 and the CCPNP gauge. **ATTENTION! Do not crimp the gauge.**

Calibration check

Put the crimping tool in the completely closed position.

“GO” - Insert the end (green) of the gauge as shown (Fig. 1). The gauge must pass freely between the indenter tips.

“NO GO” - Insert the end (red) of the gauge as shown (Fig. 2). The gauge should not pass through the opening.

Gauge	tool selector pos. No.	Ø A ± 0.00254 mm (go) green	Ø B ± 0.00254 mm (no go) red
CCPNP	4	0.991 (mm)	1.118 (mm)

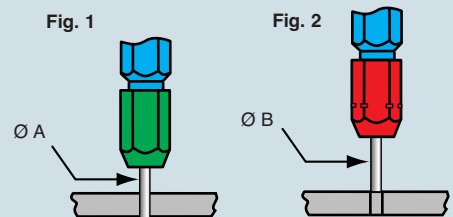

for contacts of insert series:	page
CX 6/36* (40A)	130
CX 12/2* (40A)	131
MIXO (40A)	138÷139

* the underlined polarities indicate those contacts that require the tools shown in this page

**) On request is possible to supply the pneumatic crimping tool version (part. No. CXPZP D), please contact us for further details.

manual crimping tool **)
turret heads
gauge



removal tool



description	part No.	part No.
crimping tool for 40A DANIELS M309 model (turret excluded)	CXPZ D	
turret heads (see note) - for <u>male</u> contacts 40A - for <u>female</u> contacts 40A	CXTP 40 M CXTP 40 F	
"go / no go" control gauge to verify indenter closure (see note)	CXPNP	
removal tool for the extraction of contacts from the inserts - for 40A contacts		CXES

Notes:

Positioning turret

- An interchangeable and indispensable accessory of the CXPZ D crimping tool, it precisely positions the contact where crimping is performed. Each series of contacts (male or female) requires its own turret.

"go / no go" control gauge

- A tool used to periodically check that the crimping tool meets standard requirements.

CXPZ D

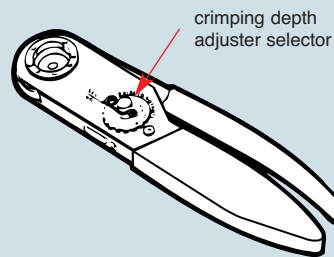

CXES

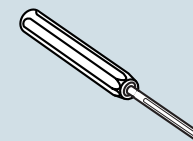

CXPNP

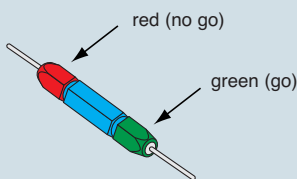

CXTP 40 M and CXTP 40 F

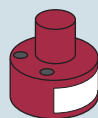

General specifications

The CXPZ D crimping tool performed with 8 pressure points. The tool is equipped with a geared mechanism to control the complete crimping cycle.

The tool must be equipped with an interchangeable turret (CXTP) according to the series of contacts to be crimped.

Crimping range

Wire section:
dimension from 1.5 mm² (16 AWG) to 6 mm² (10 AWG)

Caution!

The handle of the tool must be in the open position when the turret is installed, disassembled or opened. If not, the turret and the crimping tool may be damaged.

CXTP turret installation

1. The crimping tool must be in the open position.
2. Choose the turret to be used, according to the contacts that should be crimped (male or female).
3. Position the previously selected CXTP turret on the support ring located on the crimping tool (matching the special pin on the base of the turret with the corresponding hole on the support ring), aligning the tapped holes with the socket head screws.
4. With the CXTP turret positioned against the support ring, tighten the socket head screws with the 3.5 mm Allen wrench (supplied with the kit).
5. Refer to the data plate on the CXTP turret. From the column indicating the proper conductor section, determine the number that corresponds to the contact being used.
6. Remove the retaining hook from the crimping tool selector dial. Lift the selector dial and turn it until the selector number is aligned with the indicator (SEL.NO.). Replace the retaining hook (if necessary).

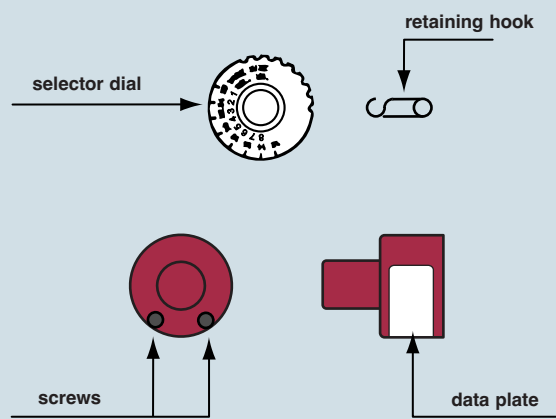
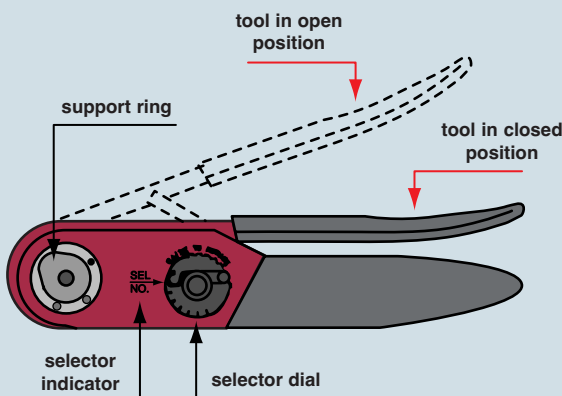

Crimping instructions

1. Insert the contact and the prepared conductor through the opening of the indenter in the turret positioner.
2. Tighten the crimping tool handle until the stop gear is released. The tool will return to the open position.
3. Check the position of the crimping on the contact crimping foot. Ideally, the crimping should be between the inspection hole and the top edge of the crimping foot. The head of the contact should not be squared and the inspection hole should be intact.

Crimping tool maintenance

No maintenance is required. However, it is good practice to keep the indenter tips free from residual deposits of the coloured band (some types of crimp contacts as per MIL standards are identified by coloured bands in the crimping area) and any other debris. A metal brush may be used for this purpose. The following is strongly recommended:

1. DO NOT immerse the tools in a solution to clean them.
2. DO NOT brush oil in the tools to lubricate them.
3. DO NOT try to disassemble the tool or repair it.

This is a high-precision manual crimping tool and must be used as such.

Removing the CXPT turret

With the crimping tool in the open position, to disassemble the turret, loosen the socket head screws using the 3.5 mm Allen wrench (supplied with the kit). After the threads are released from the support ring, pull off the turret with a straight movement.

Instructions to check calibration

The operations to check the crimping tool must be carried out with the selector dial in position 4 and the CCPNP gauge. **ATTENTION! Do not crimp the gauge.**

Calibration check

Put the crimping tool in the completely closed position.

“GO” - Insert the end (green) of the gauge as shown (Fig. 1). The gauge must pass freely between the indenter tips.

“NO GO” - Insert the end (red) of the gauge as shown (Fig. 2). The gauge should not pass through the opening.

Gauge	tool selector pos. No.	Ø A ± 0.00254 mm (go) green	Ø B ± 0.00254 mm (no go) red
CXPNP	4	1.549 (mm)	1.676 (mm)

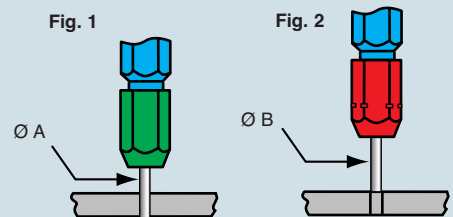

for contacts of insert series:	page
CD (10A)	39÷47
CDD (10A)	53÷60
CDC (16A)	67÷71
CQ (16A)	63÷64
CQE (16A)	74÷79
CCE (16A)	86÷96
CMCE (16A)	114÷125
CX 8/24 (16A/10A)	129
CX 6/36 (40A/10A)	130
CX 12/2 (40A/10A)	131
MIXO (40A/16A/10A)	138÷148

manual crimping tool gauge



insertion tool removal tools - tip



description	part No.	part No.
crimping tool for 10A, 16A and 40A contacts RENNSTEIG model (turret included)	CCPZ RN	
"go / no go" control gauge to verify indenter closure (see note)	CCPNP RN	
insertion tool for insertion of the contacts into the inserts for crimped contacts up to 0.75 mm ²		CCINA
removal tools for the extraction of contacts from the inserts - for 10A contacts ¹⁾ - for 16A contacts ²⁾ - for 40A contacts ³⁾		CCES CQES CXES
replacement tip for CCES removal tool		CCPR RN

Notes:

- 1) for CD, CDD, CX inserts (10A auxiliary contacts) and MIXO module (10A)
- 2) for CQ, CQE, CCE, CMCE inserts (excluded 16+2) and MIXO module (16A) for CDC, CMCE (16+2), CX inserts (contacts 16A insert CX 8/24) using a flat 3 mm screwdriver
- 3) for CX inserts (40A contacts) and MIXO module (40A)

"go / no go" control gauge

- A tool used to periodically check that the crimping tool meets standard requirements.

CCPNP RN

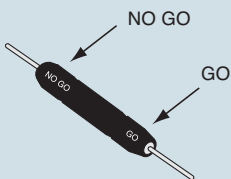

CCPZ RN

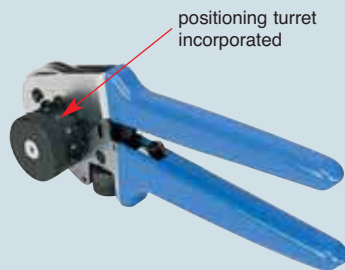

CCINA

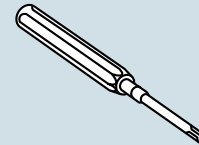

CCES

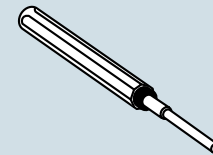

CCPR RN

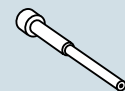

CQES

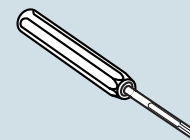

CXES

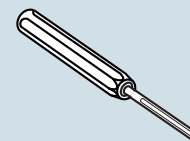

General specifications

The CCPZ RN crimping tool crimps with 8 pressure points, obtaining similar results to the prescriptions of standard MIL-C-22520/1. The tool has a geared mechanism for controlling the complete crimping cycle, and houses a positioning turret with 12 positions, three of which can be used for positioning the ILME male and female crimping contacts of series CD (10A max), CCE (16A max) and CX (40A max).

Crimping range

Wire section: dimension from 0.14 mm² (26 AWG) to 6 mm² (10 AWG)

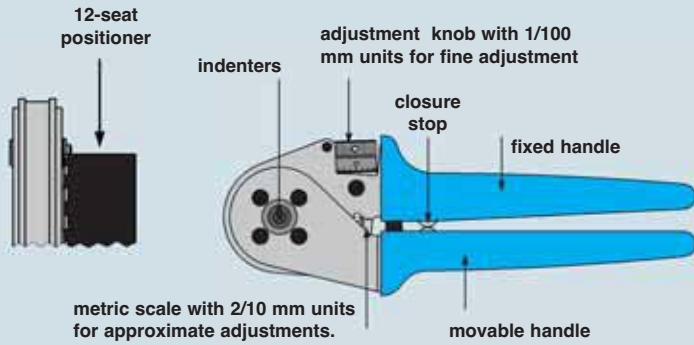

Description of tool

Crimping tool components: a first mobile handle, with a precision stop mechanism with teeth and an opening limiting guide; a second fixed handle with metric scale (units of 2/10 mm); an adjustment system with fine step adjustments of 1/100 mm; four indenters; a 12-seat positioner, fully rotating through 360° for accurate positioning of contacts. A reference table engraved on the tool surface provides the positioner (POS) number and crimping depth (SET) to select according to the type and size of the ILME contact (the crimping tool can be set to any crimping depth which may be required by the contact manufacturer).

Crimping instructions

The reference matrix on the crimping tool indicates the correct seat of the positioner (POS 1,2, or 3) to select, and the crimping depth (SET) to adjust for the contact to be crimped. The contact is inserted through the crimper entry hole on the opposite side of the positioner. The contact is closed by closing the handles in the first stop position, in order to prevent the contact coming out off the crimper and to facilitate fitting the conductor in the contact.

The precision stop mechanism with teeth ensures consistently precise crimps, by forcing the crimper to close completely and finish the crimping cycle before the crimper can be re-opened.

Adjustment tool

Positioner seat = 1

CDMA/D (male) CCFA/D (female)	Section (mm ²)	Crimp depth (mm)
0.3	0.14	1.3
	0.25	
	0.37	
0.5	0.5	1.55
0.7	0.75	1.55
1.0	1.0	1.55
1.5	1.5	1.55
2.5	2.5	1.55

Positioner seat = 2

CCMA/D (male) CCFA/D (female)	Section (mm ²)	Crimp depth (mm)
0.5	0.5	1.55
0.7	0.75	1.55
1.0	1.0	1.55
1.5	1.5	1.8
2.5	2.5	1.8
4.0	4	2.0

Positioner seat = 3

CXMA/D (male) CXFA/D (female)	Section (mm ²)	Crimp depth (mm)
1.5	1.5	1.55
2.5	2.5	1.8
4.0	4	2.0
6.0	6	2.5

Adjustment of crimp depth

Crimp depth to be adjusted ad follows:

the adjustment knob should be turned clockwise to reduce crimping depth, and anti-clockwise to increase it.

Adjustment tolerances:

- 1 scale mark on the knob = adjustment of 1/100 mm (0.01 mm)
- 1 complete rotation of knob = adjustment of 2/10 mm (0.2 mm, this indication can be read on the knob and on the approximate scale)
- 5 knob rotations = adjustment of 1.0 mm (this indication can be read on the scale)

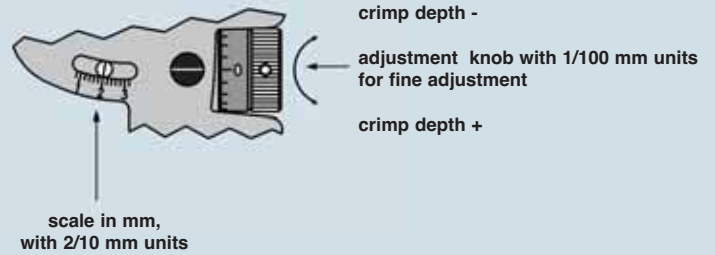

Maintenance and repair

Keep the crimping tool clean and store it correctly when not in use. The joints need to be lubricated periodically, and the pin stop circular clips must always stay in position. This is a high precision crimping tool and must be used as such.

Calibration check

The crimping tool is adjusted in the manufacturer's plant. To ensure correct calibration, we advise you to check the tool with a gauge every working day.

This is easily done with the CCPNP RN cylindrical gauge in the 2.0 mm Ø position.

ATTENTION!: Do not crimp the gauge.

Crimping depth of 2 mm can be adjusted with the adjustment knob (scale marked on "2", screw indicator on "0" as shown in the above figure).

Put the crimping tool in the completely position.

"GO" - Insert the end of the gauge as shown (Fig. 1).

The gauge must pass freely between the indenter tips.

"NO GO" - Insert the end of the gauge as shown (Fig. 2).

The gauge should not pass through the opening.

Gauge	tool selector pos. No.	Ø A GO	Ø B NO GO
CCPNP RN	2	1.94 (mm)	2.06 (mm)

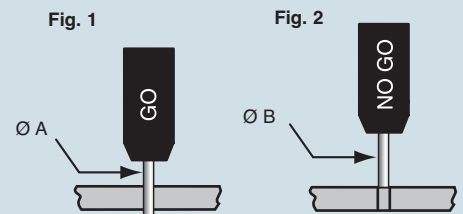

for contacts of insert series:
MIXO (100A) page 137

**manual crimp pliers
 crimp matrixes**



carrying case



description	part No.	part No.
crimp pliers for 100A CG series contacts basic tool mod. CEMBRE HT 45 with built-in ILME locator (excluding crimp matrixes)	CGPZ	
crimp matrixes - for CG contacts with 16 mm ² (AWG 6 - 5) section - for CG contacts with 25 mm ² (AWG 4 - 3) section - for CG contacts with 35 mm ² (AWG 2) section	CGD 16 C CGD 25 C CGD 35 C	
thermoplastic carrying case for CGPZ* pliers - dimensions 445 x 290 x h 95mm - weight 1.2kg houses 20 pairs of matrixes		CGPZ VLG

Note:
 * to store the CGPZ pliers inside the carrying case, turn the pliers head by 180° so that the locator becomes visible.

General specifications

The **CGPZ** pliers are a hydraulically operated tool suitable for manually crimping **ILME CG** series (100A max) removable crimp contacts which may be used in **MIXO** series type **CG** (page 3) modular inserts and **CGT 16** adaptor to connect 16 mm² flexible safety wires to the largest of MIXO series frame earth terminals.

By using a suitable, hexagonal footprint crimp matrix pair, these pliers allow crimped connections to be made which conform to the highest quality standards.

The main features of these pliers are listed below:

- Scope of application: suitable for crimping wire terminals for up to 150 mm² flexible copper wires.
- Force developed: 50 kN (6 tons)
- Nominal operating pressure: 600 bar (8.600psi)
- Dimensions: length 346 mm (13.6")
 - width (locked moving handle) 130 mm (5.1")
 - width (free moving handle) 250 mm (9.8")
- Weight: (without matrixes and without ILME locator) 2.0kg (4.4lbs)
- Recommended oil: AGIP ARNICA 32 or SHELL TELLUS OIL TX 32 or equivalent
- Other features: please read the user and maintenance manual supplied with the tool.

The pliers are equipped with a locator specifically designed for ILME CG series crimp contacts already fitted on the moving part of the pliers head by means of the Allen screw provided.

This **CGPZ LOC** locator is available on request if it needs replacing.

WARNING: For crimping the CGT 16 adaptor, the crimp locating operation must be carried out by the user.

User instructions

1) Preliminary operations

According to requirements, the pliers can be fitted with one or more pairs of crimp matrixes selected from the matrixes listed in the catalogue, to crimp the contacts shown in the table below:

article ref.	punching	contacts	mm ²	AWG min (mm ²)	AWG max (mm ²)
CGD 16 C	ME 3	CGMA 16, CGFA 16	16	6	5
		CGT 16		(13.3)	(16.8)
CGD 25 C	ME 5	CGMA 25, CGFA 25	25	4	3
				(21.2)	(26.3)
CGD 35 C	ME 7	CGMA 35, CGFA 35	35	-	2
					(33.6)

NOTE: The CG series crimp contacts are only suitable for crimping flexible copper wires featuring a nominal section shown in the table with the crimp matrixes shown in the table. Any contacts – wires – matrixes combination which does not conform to these instructions is not physically possible (ex: using 35 mm² contacts with CGD 25 C matrixes is not possible because the pliers head would not close) or produces non conforming crimped connections or not usable in the MIXO series CG type connector modules.

Open the tool head by moving the matrix supporting hook (22) outwards until the matrix support (21) is released.

With reference to Figures 1 and 2, select a pair of matrixes suitable to the type of contact and insert them in the housings: one in the matrix support (21), the other one in the matrix pusher support (26). (NB: the two matrixes of each pair are the same). Insert the contact by resting it in the locator with the tip forward, then close the head. The contact crimp housing will be accessible in the mouth between the matrixes.

NOTE: for **CGMA 35** and **CGFA 35** contacts, and their corresponding **CGD 35 C** matrix pair, the contact may be inserted even after closing the head.

Remove the moving handle (36) by removing the handle locking belt from the handle. Before carrying out the next operations, make sure the head is fully closed to avoid damages.

The pliers head can rotate by 180° in relation to the body, thus allowing the operator to work in the most comfortable position.

WARNING: do not force the head by trying to rotate it when the tool is under pressure.

2) Approaching the matrixes

If possible, rest the pliers head on a work top, then move the moving handle to start moving the matrixes closer to the contact, then carry on moving them until the contact is locked between the matrixes.

Push the correctly stripped and suitable long (15 mm) wire all the way in the contact (or the CGT adaptor) crimp housing by carefully checking that the braids are fully compacted, are not damaged and, above all, are all fully inserted.

Correctly pushing the contact in the locator ensures that the matrixes are exactly in the right area to compress (the contact crimp shaft centre). Make sure that the locator is free from any residue which would alter the position of the contact.

For crimping the CFT 15 earth adaptor, manually locate the area to be crimped between the matrixes. If necessary, re-open the matrixes by following the instructions described in paragraph 4 and reposition the contact.

3) Crimping

Continue to operate the moving handle (pumping): the piston will gradually move forward until the matrixes come into contact. Continue the pumping action until the maximum pressure valve clicks in.

4) Releasing the matrixes

Fully press the pressure release lever (50) located on the pliers pumping body until the piston goes back and the matrixes open.

To remove the crimped contact, re-open the pliers head.

5) Storage

Fully return the piston as described in paragraph 4, then lock the moving handle in position by using the belt provided.

Cleaning and maintenance

The tool is very sturdy and does not require any special care; a correct operation is ensured by following a few simple precautions.

The tool is supplied with a user and maintenance manual, which gives all detailed instructions. Read this manual before use.

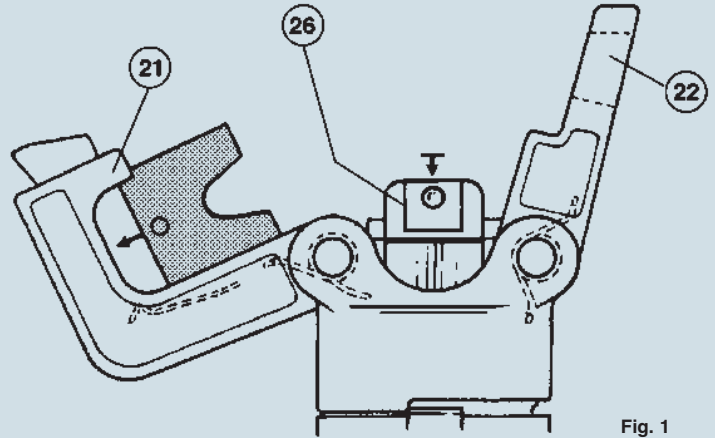

Fig. 1

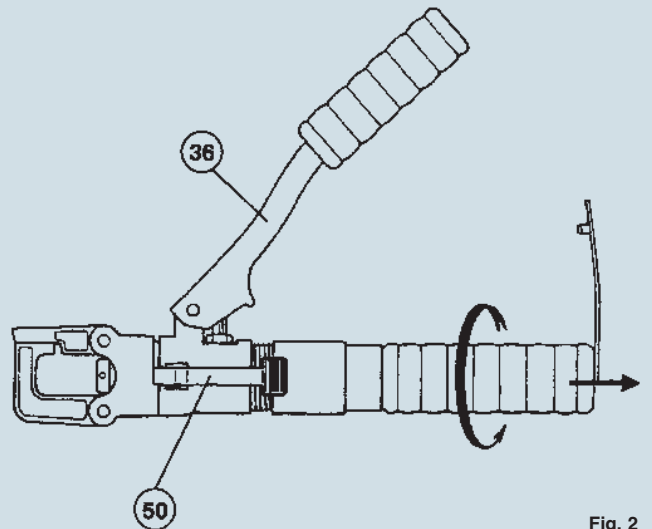

Fig. 2

for contacts of insert series:	page
CD (10A)	39÷47
CDD (10A)	53÷60
CDC (16A)	67÷71
CQ (16A)	63÷64
CQE (16A)	74÷79
CCE (16A)	86÷96
CMCE (16A)	114÷125
CX 8/24 (16A/10A)	129
CX 6/36 (10A)	130
CX 12/2 (10A)	131
MIXO (16A/10A)	140÷148

* the underlined polarities indicate those contacts that require the tools shown in this page

**pneumatic crimping tool
turret heads - gauge**



**insertion tool
removal tools - tip**



description	part No.	part No.
pneumatic crimping tool for 10A and 16A contacts model DANIELS WA27F (turret excluded)	CCPZP	
turret heads (see note) - for 10A contacts (CDF and CDM series) - for 16A contacts (CCF and CCM series)	CCTP 10 CCTP 16	
support for CCPZP pneumatic crimping tool	CCSPZP	
pneumatic foot valve	CCVPP	
"go / no go" control gauge to verify indenter closure (see note)	CCPNP	
insertion tool for insertion of the contacts into the inserts for crimped contacts up to 0.75 mm ²		CCINA
removal tools for the extraction of contacts from the inserts - for 10A contacts ¹⁾ - for 16A contacts ²⁾		CCES CQES
replacement tip for CCES removal tool		CCPR RN

Notes:

- 1) for CD, CDD, CX inserts (10A auxiliary contacts) and MIXO module (10A)
- 2) for CQ, CQE, CCE, CMCE inserts (excluded 16+2) and MIXO module (16A) for CDC, CMCE (16+2), CX inserts (contacts 16A insert CX 8/24) using a flat 3 mm screwdriver

Positioning turret

conforms to international standard MIL-C-22520/1

- An interchangeable and indispensable accessory of the CCPZP crimping tool, it precisely positions the contact where crimping is performed. Each series of contacts requires its own turret.

"go / no go" control gauge

conforms to international standard MIL-C-22520/3

- A tool used to periodically check that the crimping tool meets standard requirements.

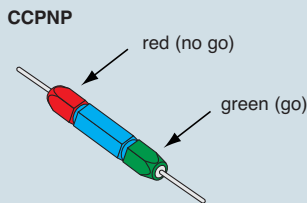

CCPZP

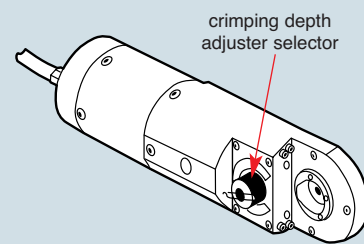

CCTP

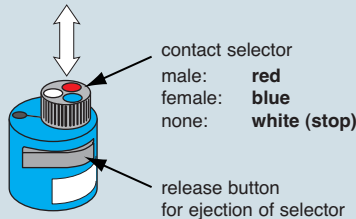

CCSPZP

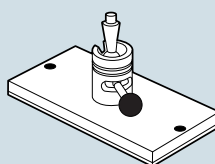

CCVPP

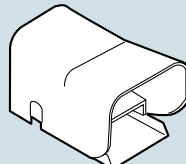

CCINA

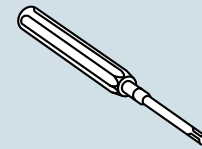

CCES

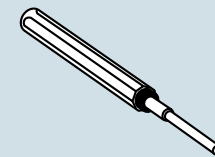

CCPR RN

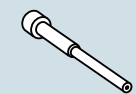

CQES

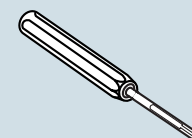

General specifications

This is the pneumatic version of the crimping tool. Crimping is performed with 8 pressure points. The tool is equipped with a geared mechanism to control the complete crimping cycle.

The tool must be equipped with an interchangeable turret (CCTP) according to the series of contacts to be crimped.

It is possible to use a hand valve (located on the crimping tool) or a foot valve (optional). The tool operating pressure is 5.5 ÷ 8.3 bar. It is recommended to utilise a lubrication, adjustment and air filtering unit.

Crimping range

Wire section: dimension from 0.12 mm² (26 AWG) to 4 mm² (12 AWG).

Operation with foot valve (optional)

Connect the foot valve between the compressed air source and the tool air inlet. Lower the hand valve and stop it in the lowered position with the stop screw (A) using a 1.5 mm Allen wrench.

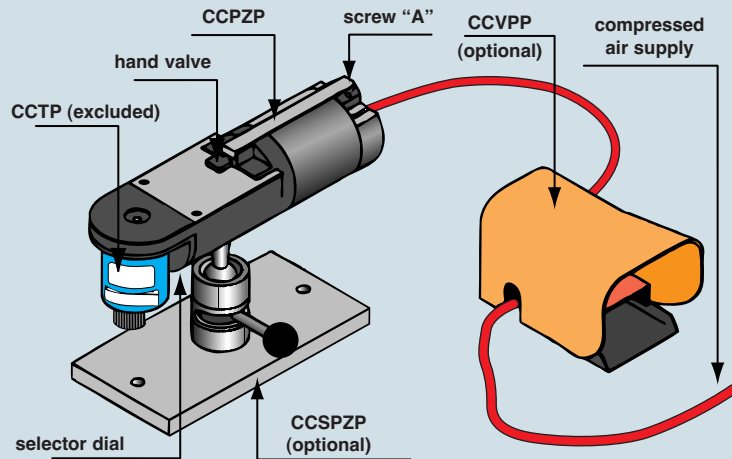

Checking the crimping complete cycle control mechanism

Correct operation can be checked based on the following procedure:

1. Install a CCTP turret.
2. Reduce the pressure to 1 bar.
3. Using a contact that corresponds to the installed turret, with size 0.5, and a wire with section 0.5 mm², use the crimping tool, referring to the crimping instructions. The indenters will not reach the fully closed position and the contact will be internally blocked if the geared mechanism is operating correctly.
4. To release the partially crimped contact, increase the air pressure of the line to 5.5 ÷ 8.3 bar and again use the crimping tool. It will then complete the crimping, allowing the indenters to return to the fully open position.

Crimping instructions

1. Insert the contact and the prepared conductor through the opening of the indenter in the turret positioner.
2. Activate the hand valve or the optional foot valve. Once crimping has been completed, the tool will return to the open position.
3. Check the position of the crimping on the contact crimping foot. Ideally, the crimping should be between the inspection hole and the top edge of the crimping foot. The head of the contact should not be squared and the inspection hole should be intact.

Crimping tool maintenance

No maintenance is required. However, it is good practice to keep the indenter tips free from residual deposits of the coloured band (some types of crimp contacts as per MIL standards are identified by coloured bands in the crimping area) and any other debris. A metal brush may be used for this purpose. The following is strongly recommended:

1. DO NOT immerse the tools in a solution to clean them.
2. DO NOT brush oil in the tools to lubricate them.
3. DO NOT try to disassemble the tool or repair it.

This is a high-precision crimping tool and must be used as such.

CCTP turret installation

1. Position the previously selected CCTP turret on the support ring located on the crimping tool (matching the special pin on the base of the turret with the corresponding hole on the support ring), aligning the tapped holes with the socket head screws.
2. With the CCTP turret positioned against the support ring, tighten the socket head screws with the 3.5 mm Allen wrench (supplied with the kit).
3. Refer to the data plate on the CCTP turret. From the colour code column, select the colour of the positioner that corresponds to the appropriate code and dimension of the contact to be crimped.
4. With the CCTP turret in the adjustment position, turn the turret until the colour-coded positioner is aligned with the indicator line. Press the turret until it clicks into the connected position.
5. Refer to the data plate on the CCTP turret. From the column indicating the proper conductor section, determine the number that corresponds to the contact being used.
6. Remove the retaining hook from the crimping tool selector dial. Lift the selector dial and turn it until the selector number is aligned with the indicator (SEL.NO.). Replace the retaining hook (if necessary).

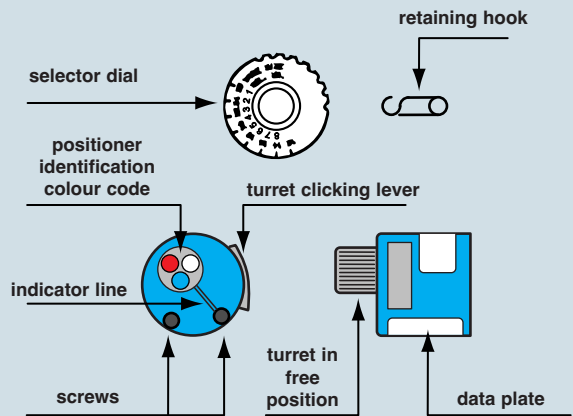

Removing the CCTP turret

With the crimping tool in the open position, to disassemble the turret, loosen the socket head screws using the 3.5 mm Allen wrench (supplied with the kit). After the threads are released from the support ring, pull off the turret with a straight movement.

Releasing a partially crimped contact

To release a partially crimped contact, do the following:

1. Increase the air pressure to 8.5 bar and use the crimping tool. If the increase in air pressure does not release the contact, do the following.
2. Turn the selector dial clockwise to the highest lockable setting (the selector dial must be in the blocked position before continuing). Use the crimping tool.
3. If it does not release after several attempts, contact the ILME offices.

Instructions to check calibration

The operations to check the crimping tool must be carried out with the selector dial in position 4 and the CCPNP gauge. **CAUTION! Do not crimp the gauge.**

Calibration check

Put the crimping tool in the completely closed position.

“GO” - Insert the end (green) of the gauge as shown (Fig. 1). The gauge must pass freely between the indenter tips.

“NO GO” - Insert the end (red) of the gauge as shown (Fig. 2). The gauge should not pass through the opening.

Gauge	tool selector pos. No.	Ø A ± 0.00254 mm (go) green	Ø B ± 0.00254 mm (no go) red
CCPNP	4	0.991 (mm)	1.118 (mm)

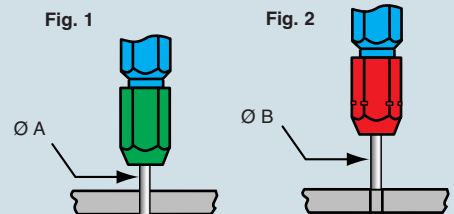

for contacts of insert series:	page
CD (10A)	39÷47
CDD (10A)	53÷60
CDC (16A)	67÷71
CQ (16A)	63÷64
CQE (16A)	74÷79
CCE (16A)	86÷96
CMCE (16A)	114÷125
CX 8/24 (10A/16A)	129
CX 6/36 (10A)	130
CX 12/2 (10A)	131
MIXO (10A/16A)	140÷148

* the underlined polarities indicate those contacts that require the tools shown in this page

pneumatic crimping tool with automatic positioner - inserts - gauge

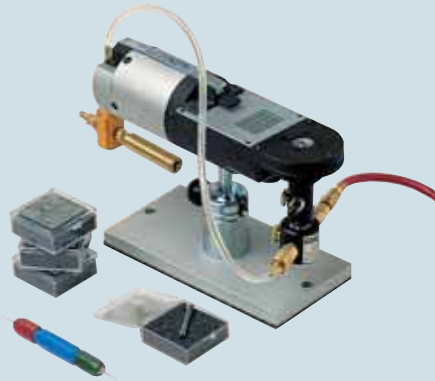

**insertion tool
removal tools - tip**



description	part No.	part No.
crimping tool with automatic positioner model DANIELS WA27FAP (inserts excluded)	CCPZPA	
positioner inserts (see note) - male contacts 10A (CDM series) - female contacts 10A (CDF series) - male contacts 16A (CCM series) - female contacts 16A (CCF series)	CCTPADM CCTPADF CCTPACM CCTPACF	
"go / no go" control gauge to verify indenter closure (see note)	CCPNP	
insertion tool for insertion of the contacts into the inserts for crimped contacts up to 0.75 mm ²		CCINA
removal tools for the extraction of contacts from the inserts - for 10A contacts ¹⁾ - for 16A contacts ²⁾		CCES CQES
replacement tip for CCES removal tool		CCPR RN

Notes:

- for CD, CDD, CX inserts (10A auxiliary contacts) and MIXO module (10A)
- for CQ, CQE, CCE, CMCE inserts (excluded 16+2) and MIXO module (16A) for CDC, CMCE (16+2), CX inserts (contacts 16A insert CX 8/24) using a flat 3 mm screwdriver

Positioner inserts

- Interchangeable and indispensable accessories of the CCPZPA crimping tool precisely position the contact where crimping is performed. Each contact requires its own positioner insert selected according to the type of contact (10A or 16A) and the kind (male or female).

"go / no go" control gauge

conforms with international standard MIL-C-22520/3
- A tool used to periodically check that the crimping tool meets standard requirements.

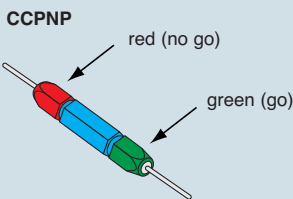

CCPZPA

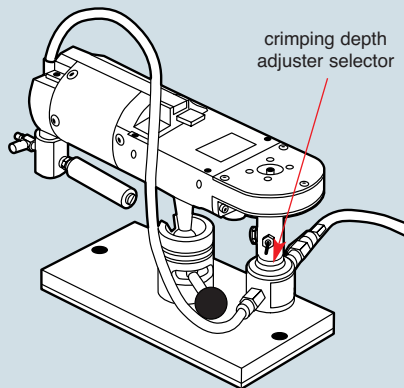

**CCTPADM and CCTPADF
CCTPACM and CCTPACF**

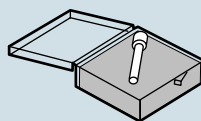

CCINA

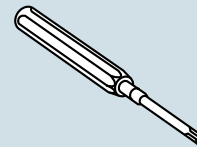

CCES

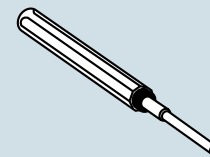

CCPR RN

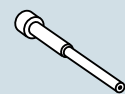

CQES

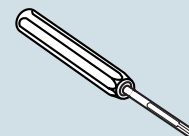

General specifications

This is the pneumatic version of the manual crimping tool. Crimping is performed with 8 pressure points. The tool is equipped with a geared mechanism to control the complete crimping cycle.

Thanks to the automatic positioner it is possible to crimp simply by inserting the uncrimped contact + wire into the tool crimping cavity.

It is also necessary to order the interchangeable positioner inserts relative to the series of contacts to be crimped.

The tool operating pressure is $5.5 \div 8.3$ bar. It is recommended to utilise a lubrication, adjustment and air filtering unit.

Crimping range

Wire section: dimension from 0.12 mm^2 (26 AWG) to 4 mm^2 (12 AWG).

Fig. A (complete crimping tool)

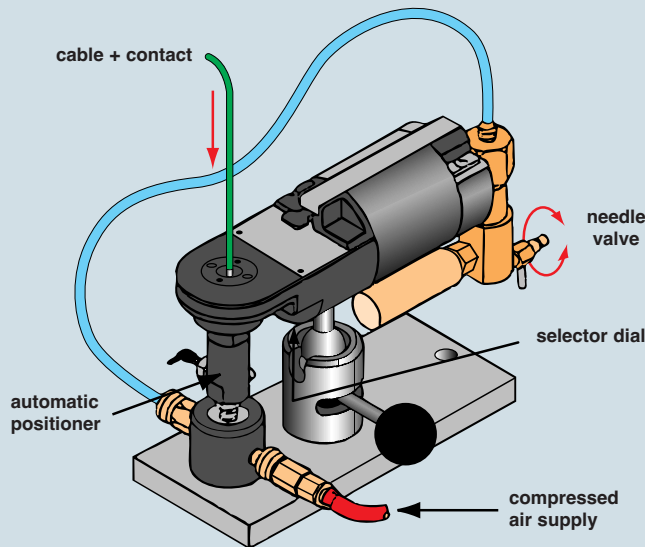

Checking the crimping complete cycle control mechanism

Correct operation can be checked based on the following procedure:

1. Reduce the pressure to 1 bar.
2. Using a contact that corresponds to the installed positioner, with size 0.5, and a wire with section 0.5 mm^2 , use the crimping tool, referring to the crimping instructions. The indenters will not reach the fully closed position and the contact will be internally blocked if the geared mechanism is operating correctly.
3. To release the partially crimped contact, increase the air pressure of the line to $5.5 \div 8.3$ bar and again use the crimping tool. It will then complete the crimping, allowing the indenters to return to the fully open position.

Crimping instructions

1. To obtain the suitable selector number, refer to the data plate located on the cover of the positioner case, and adjust the selector dial as specified.
2. Insert the contact and the prepared conductor through the opening of the indenter in the crimping tool casing (Fig. A).
3. Exert slight pressure until the crimping tool automatically crimps the contact. **CAUTION: Wire sections less than 0.34 mm^2 (24 AWG) up to 0.08 mm^2 (28 AWG) or equivalent are not sufficiently rigid, so that it may be rather difficult to push the contact + wire.**
4. Check the position of the crimping on the contact crimping foot. Ideally, the crimping should be between the inspection hole and the top edge of the crimping foot. The head of the contact should not be squared and the inspection hole should be intact.

Crimping tool maintenance

No maintenance is required. However, it is good practice to keep the indenter tips free from residual deposits of the coloured band (some types of crimp contacts as per MIL standards are identified by coloured bands in the crimping area) and any other debris. A metal brush may be used for this purpose. The following is strongly recommended:

1. DO NOT immerse the tools in a solution to clean them.
2. DO NOT brush oil in the tools to lubricate them.
3. DO NOT try to disassemble the tool or repair it.

This is a high-precision crimping tool and must be used as such.

Installation or replacement of a positioner insert

1. Disconnect the workshop compressed air source.
2. Disconnect the air hoses from the automatic positioner (rapid connectors).
3. Remove the connection screws, using the 3.5 mm Allen wrench (supplied with the kit), to separate the automatic positioner from the crimping tool.
4. Unscrew the positioner closing housing.
5. Install or replace the proper positioner insert in the positioner housing, replacing the underlying spring.
6. Reverse the operations, as described from point 4 to point 1.

Fig. B (automatic positioner)

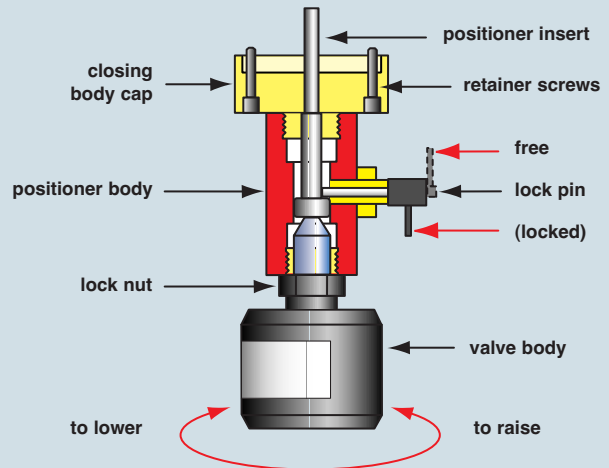

Crimping position adjustment (Fig. B)

1. Release the automatic positioner from the crimping tool body (see points 1 and 2 "Installation replacement of a positioner insert").
2. While holding the positioner body in position using a 19 mm wrench, loosen the lock nut with a 14 mm wrench.
3. Push the positioner insert toward the bottom and lock it using the lock pin.
4. If the pin doesn't lock, unscrew the valve body toward the bottom.
5. With the pin locked, tighten the valve body toward the top until it strikes against the positioner insert.
6. While maintaining that position, tighten the lock nut.
7. Replace and connect the positioner on the crimping tool.
8. Release the lock pin in the "free" position.

Instructions to check calibration

The operations to check the crimping tool must be carried out with the selector dial in position 4 and the CCPNP gauge. **CAUTION! Do not crimp the gauge.**

Calibration check

1. Disconnect the compressed air.
2. Push the positioner insert toward the bottom and lock it using the lock pin.
3. Reconnect the compressed air.
4. Turn the needle valve counterclockwise to open the air supply (Fig. A).
5. The indenters will extend and remain in the extracted position until the valve is closed.
6. Check using the gauge, referring to the "go / no go" instructions reported below.
7. When the calibration check has been completed, close the needle valve turning it clockwise (Fig. A).
8. Put the lock pin in the "free" position.

"GO" - Insert the end (green) of the gauge as shown (Fig. 1). The gauge must pass freely between the indenter tips.

"NO GO" - Insert the end (red) of the gauge as shown (Fig. 2). The gauge should not pass through the opening.

Gauge	tool selector pos. No.	$\varnothing A \pm 0.00254 \text{ mm}$ (go) green	$\varnothing B \pm 0.00254 \text{ mm}$ (no go) red
CCPNP	4	0.991 (mm)	1.118 (mm)

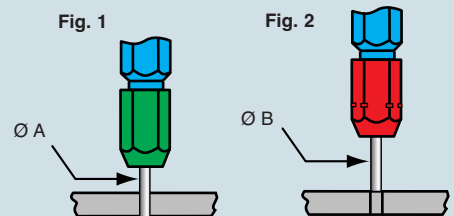

for contacts of insert series:	page
CD (10A)	39÷47
CDD (10A)	53÷60
CDC (16A)	67÷71
CQ (16A)	63÷64
CQE (16A)	74÷79
CCE (16A)	86÷96
CMCE (16A)	114÷125
CX 8/24 (10A/16A)	129
CX 6/36 (10A)	130
CX 12/2 (10A)	131
MIXO (10A/16A)	140÷148

* the underlined polarities indicate those contacts that require the tools shown in this page

stripping - crimping machine



insertion tool

removal tools - replacement tip



description	part No.	part No.
stripping, crimping machine Zoller+Fröhlich AM-03 Universal model	ZFU-CD	
insertion tool for insertion of the contacts into the inserts for crimped contacts up to 0.75 mm ²		CCINA
removal tools for the extraction of contacts from the inserts - for 10A contacts 1) - for 16A contacts 2)		CCES CQES
replacement tip for CCES removal tool		CCPR RN

Notes:

1) for CD, CDD, CX inserts (10A auxiliary contacts) and MIXO module (10A)

2) for CQ, CQE, CCE, CMCE inserts (excluded 16+2) and MIXO module (16A). For CDC, CMCE (16+2), CX inserts (16A contacts CX 8/24 insert) a 3 mm flat screwdriver should be used

Technical specifications

Drive	electro-pneumatic
Electric feeder	230V/50Hz
Absorbed power	120VA
Fuse (on the system filter module)	2 x 2 A mT
Air operating pressure	5.5 bar
Air consumption	2 ml/cycle
Flexible conductors in conformity with.....	IEC 60228 class 5
Rated section	0.34-2.5 mm ² (22 AWG-14 AWG)
Feeding length	52 mm
Contacts	loose, turned
Contact breaker	see list of tools
Feeding	vibrating conveyor
Crimping form.....	4/8 ratchets
Cycle time	2.5 s - 3 s
Continuous sound level	<70 dB (A)
Dimensions (l x d x h).....	(530 x 500 x 480) mm
Colour.....	blue, RAL 5012
Weight.....	40 Kg

Tools list

contacts	CD... (10A max)						CC... (16A max)					
conductor section (mm ²)	0.34	0.5	0.75	1.0	1.5	2.5	0.5	0.75	1.0	1.5	2.5	
AWG (approximate)	22	20	18	18	16	14	20	18	18	16	14	
feeding bowl/male	A						B (M)					
feeding bowl/female							B (F)					
feeding tube	A						B					
wire holder	0.34	0.5-1.5				2.5	0.5-1.5					2.5
starting unit	AB						AB					
stripping blades	V-shaped blades						V-shaped blades					
rear blade spacers	0.5 mm / 1.0 mm						0.5 mm / 1.0 mm					
left/right												
contact holder / pins	A (M)						B					
contact holder / bushes	A (F)											
contact stop	A						B					

Preset stripping and contact crimping programs

	CD... (10A max)						CC... (16A max)				
conductor section (mm ²)	0.34	0.5	0.75	1.0	1.5	2.5	0.5	0.75	1.0	1.5	2.5
AWG (approximate)	22	20	18	18	16	14	20	18	18	16	14
Program number	1A	2A	3A	4A	5A	6A	7B	8B	9B	10B	11B
stripping position (mm)	0.75	1.00	1.20	1.30	1.40	1.70	1.00	1.20	1.30	1.40	1.70
crimping position	1.30	1.35	1.40	1.50	1.55	1.60	1.40	1.40	1.50	1.55	1.70

Supplied with the following accessories:

- 1 vibrating conveyor feeder bowl for CD contact series
- 1 vibrating conveyor feeder bowl for male CC contact series
- 1 vibrating conveyor feeder bowl for female CC contact series
- 1 feeder tube (contact passage from vibrating conveyor to machine) for CD contact series
- 1 feeder tube (contact passage from vibrating conveyor to machine) for CC contact series
- 1 contact holder (in crimping position) for male CD contact series
- 1 contact holder (in crimping position) for female CD contact series
- 1 contact holder (in crimping position) for CC contact series
- 1 contact stop for CD contact series

- 1 contact stop for CC contact series
- 1 wire holder for 0.34 mm² cables
- 1 wire holder for 0.5 to 1.5 mm² cables
- 1 wire holder for 2.5 mm² cables
- 1 "GO / NO GO" control gauge
- 1 Allen wrench for setup operations
- 1 set of spacers to regulate the stripping length
- 1 removal tool to extract contacts from the crimping chamber

crimping tools

General specifications

The Zoller+Fröhlich AM-03 Universal stripping-crimping machine is a semi-automatic, electro-pneumatically operated bench machine used to quickly and reliably strip flexible copper wires and to crimp loose, turned crimp male and female, **CD** series (10A max) and **CC** series (16A max) contacts in a single run.

The contacts are automatically fed by means of a vibro-conveyor unit fitted on the top section of the machine.

The machine carries out the crimping operation with four, eight pressure point indenters, in compliance with the requirements set out in the MIL-C-22520/1 standard. The stripping depth and crimping depth adjustment is controlled by a software controlled motor. Up to 50 different combinations may be stored and retrieved from the program; these combinations are useful, for example, to meet different requirements related to the wire insulator type and thickness. The adjustment and programming operations are carried out by using the keypad located on the front panel. The LCD display shows all the functions, the main information and any errors.

The machine is fitted with devices used to check that the crimping cycle has been completed.

The general safety instructions described in the machine user and maintenance manual must be followed and the use of the machine should only be restricted to qualified and trained personnel.

Operational setups

The tool carrier carriage may be accessed by opening the front door, by anticlockwise rotation of the knob, which releases the pressure from all the valves. For tool selection, see table on page 308.

- For CD series male and female crimp contacts (10A max), the feeding cup A must be fitted onto the machine, whilst for CC series crimp contacts (16A max) feeding cup B (M) for male contacts and B (F) for female contacts must be used.
- The feeding tubes to be fitted are A for CD series contacts and B for CC series contacts respectively.
- The wire holders which support the wire during the stripping stage feature three different sizes for CD contacts and two sizes for CC contacts.
- The contact holders are two (A (M) for male contacts and A (F) for female contacts) for CD series contacts, according to the different rear diameter between male and female contacts in this series, whilst there is only one holder (B) for CC series contacts.
- The contact holder is A for CD series contacts and B for CC series contacts.

Feeding the wire

The wire must be cut straight and the single braids must not be bent or pulled apart; in particular, the first 4cm must be perfectly straight.

Checking the stripping depth:

The machine can be operated simply as a stripping machine by disabling the crimping operation. Please refer to the machine user manual.

Maintenance and repairs

Stripping residues collection tray: empty the tray approximately every 2000 cycles (the frequency depends on the sizes of the stripped wire and on the stripping length). Pneumatically controlled maintenance unit: regularly drain any water that may have collected. The trap may be cleaned with water. To remove the trap, simply disconnect the air supply. The filter unit may be unscrewed for cleaning purposes, then immersed in a cleaning agent (such as petrol or oil), thoroughly washed and dried.

Checking the calibration values

The correct calibration of the machine must be periodically checked by using the "GO / NO GO" caliper supplied as standard with the machine, by following the procedure described in the machine user and maintenance manual.

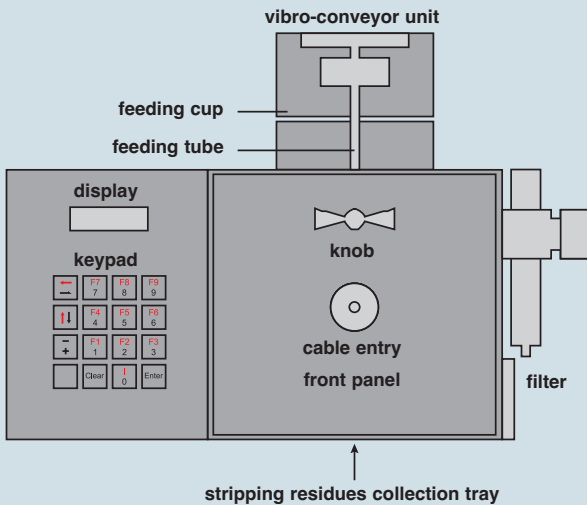

Crimping range

Wire section: from 0.34 mm² (AWG 26) to 2.5 mm² (AWG 14).

Description of the machine

To ensure a correct operation, the machine must be positioned on a hard bench, which does not amplify the effects of the internal movements occurring inside the machine. The machine consists of a vibrator which loads the contacts, of a tube which feeds the contacts and of a motorised wire stripping and contact crimping unit.

For each type and size of contact, the machine is provided with a factory stored preset program (see the machine user manual), which may be customised at any time. The program allows the user to: load, edit and save a program, as well as check/edit the stripping length and depth and the crimping depth.

Warning: when the machine is switched on, the working program is always the last program used.

The machine electronics adjustment is carried out by means of the keypad. Select one of the 12 programs (see table on page 308) according to the contact used*. Each program stores the stripping and crimping depth.

The stripping depth is the measurement in mm of how much the stripping blades must penetrate the insulator to strip it off, and depends on the type of cable used.

The crimping depth is the measurement in mm of how much the four indenters must penetrate the contact at the end of the crimping operation. This depth depends on the size and shape of the contact (crimp shaft thickness) and determines the quality of the crimping operation in terms of gas tightness and resistance to tensile stress.

*Note: the machine also has a 12C program suitable for 10 A, 2.5 mm² crimp contacts with 6mm stripping length. This program is therefore unsuitable for ILME CD series contacts (stripping length 8mm).

for insert series:

CJ (RJ45)

page

278

manual crimp pliers



screened cable stripper



description

RJ45 CJ series plug insert crimp pliers
basic tool YAMAICHI Y-ContTool-11 mod.
with plug insert inserter

Y-ContTool-20 cable stripper
cuts the cable sheath and
releases the wires in a single operation

part No.

CJPZ Y

part No.

CJST

how to use the RJ45 plug insert crimp pliers

The diagram illustrates the 11 steps for using the RJ45 plug insert crimp pliers:

- Preparation of the cable with a 6-7 mm crimp length and a 35 mm total length.
- Inserting the wires into the plug insert.
- Initial crimping of the wires.
- Trimming the wires to a 6-7 mm length, leaving a 25 mm section of the outer sheath.
- Stripping the outer sheath of the cable.
- Inserting the stripped cable into the crimping tool.
- Aligning the cable with the crimping tool's die.
- Pressing the handles together to crimp the wires.
- Releasing the crimped plug insert from the tool.
- Final inspection of the crimped plug insert.
- Final inspection of the crimped plug insert.

crimping tools





Part No.	page	Part No.	page	Part No.	page
CAC 06 L.....	237	CAP 10 CS	185	CAV 06 LG21	178
CAC 10	237	CAP 10 CS2	185	CAV 06 LG29	178
CAC 10 L.....	237	CAP 10 CS229	185	CAV 06 YX21	243
CAC 16	237	CAP 10 CS29	185	CAV 06 YX29	243
CAC 16 L.....	237	CAP 10 L.....	185	CAV 10 G	187
CAC 24	237	CAP 10 L2	185	CAV 10 G29	187
CAC 24 L.....	237	CAP 10 L229	185	CAV 10 L21	186
CAF 10	186	CAP 10 L29	185	CAV 10 L29	186
CAF 16	200	CAP 10 LS.....	185	CAV 10 LG21	187
CAF 16.221	236	CAP 10 LS2.....	185	CAV 10 LG29	187
CAF 24.21	214	CAP 10 LS229.....	185	CAV 10 X.....	188
CAF 24.221	236	CAP 10 LS29.....	185	CAV 10 X29.....	188
CAF 24.29	214	CAP 10 YC229	242	CAV 10 YX21	243
CAN 24	238	CAP 10.21	185	CAV 10 YX29	243
CAO 06 L21	178	CAP 10.221	185	CAV 10.21	186
CAO 06 L29	178	CAP 10.229	185	CAV 10.213	236
CAO 06 YX21	243	CAP 10.29	185	CAV 10.29	186
CAO 06 YX29	243	CAP 16 CP	199	CAV 16 G	200
CAO 10 L21	186	CAP 16 CP2	199	CAV 16 G29	200
CAO 10 L29	186	CAP 16 CP229	199	CAV 16 L21	200
CAO 10 X	188	CAP 16 CP29	199	CAV 16 L29	200
CAO 10 X29	188	CAP 16 CS	199	CAV 16 LG21	200
CAO 10 YX21	243	CAP 16 CS2	199	CAV 16 LG29	200
CAO 10 YX29	243	CAP 16 CS229	199	CAV 16 X.....	202
CAO 10.21.....	186	CAP 16 CS29	199	CAV 16 X29.....	202
CAO 10.29.....	186	CAP 16 L.....	199	CAV 16 YX21	243
CAO 16 L21	243	CAP 16 L2	199	CAV 16 YX29	243
CAO 16 L29	243	CAP 16 L229	199	CAV 16.21	200
CAO 16 X	202	CAP 16 L29.....	199	CAV 16.216	236
CAO 16 X29	202	CAP 16 LS.....	199	CAV 16.221	236
CAO 16 YX21	243	CAP 16 LS2.....	199	CAV 16.29	200
CAO 16 YX29	243	CAP 16 LS229.....	199	CAV 24 G	215
CAO 16.21.....	200	CAP 16 LS29.....	199	CAV 24 G29	215
CAO 16.29.....	200	CAP 16 YC229	242	CAV 24 L21	214
CAO 24 L21	200-214	CAP 16.21	199	CAV 24 L29	214
CAO 24 L29	200-214	CAP 16.221	199	CAV 24 LG21	214
CAO 24 X	216	CAP 16.229	199	CAV 24 LG29	214
CAO 24 X29	216	CAP 16.29	199	CAV 24 X.....	216
CAO 24 YX21	243	CAP 24 CP.....	199-213	CAV 24 X29.....	216
CAO 24 YX29	243	CAP 24 CP2.....	199-213	CAV 24 YX21	243
CAO 24.21.....	214	CAP 24 CP229.....	199-213	CAV 24 YX29	243
CAO 24.29.....	214	CAP 24 CP29.....	199-213	CAV 24.21	214
CAO 50 X	173	CAP 24 CS.....	199-213	CAV 24.221	236
CAO 50 X29	173	CAP 24 CS2.....	199-213	CAV 24.229	236
CAO 50.21.....	172	CAP 24 CS229.....	199-213	CAV 24.29	214
CAO 50.29.....	172	CAP 24 CS29.....	199-213	CAV 50 G29	172
CAOR 06 L21	180	CAP 24 L.....	213	CAV 50 X.....	173
CAOR 10.21	194	CAP 24 L2	213	CAV 50 X29.....	173
CAOR 16.21	208	CAP 24 L229	213	CAV 50.21	172
CAOR 24.29	222	CAP 24 L29	213	CAV 50.29	172
CAOS 06 L21	182	CAP 24 LS.....	213	CAVR 06 L21.....	180
CAOS 10.21	196	CAP 24 LS2.....	213	CAVR 10.21.....	194
CAOS 16.29	210	CAP 24 LS229.....	213	CAVR 16.21.....	208
CAOS 24.29	224	CAP 24 LS29.....	213	CAVR 24.29.....	222
CAOW 06 L21	181	CAP 24 YC229	242	CAVS 06 L21.....	182
CAOW 10.21	195	CAP 24.21	213	CAVS 10.21	196
CAOW 16.29	209	CAP 24.221	213	CAVS 16.29.....	210
CAOW 24.29	223	CAP 24.229	213	CAVS 24.29.....	224
CAOW 50.29	174	CAP 24.29	213	CAVV 06 L21	181
CAP 06 L.....	177	CAPR 10.21	194	CAVV 06 LG	181
CAP 06 L2	177	CAPR 16.21	208	CAVV 10 G	195
CAP 06 L229	177	CAPR 24.21	222	CAVV 10.21	195
CAP 06 L29	177	CAPS 06 L	182	CAVV 16 G29.....	209
CAP 06 LS.....	177	CAPS 10.21.....	196	CAVV 16.29	209
CAP 06 LS2	177	CAPS 16.21.....	210	CAVV 24.29	223
CAP 06 LS229.....	177	CAPS 24.21.....	224	CAVV 50.29	174
CAP 06 LS29.....	177	CAPW 06 L	181	CBGF	273
CAP 06 YC229	242	CAPW 10.21	195	CC 0.5 AN	63*
CAP 10 CP	185	CAPW 16.21	209	CC 0.7 AN	63*
CAP 10 CP2	185	CAPW 24.21	223	CC 1.0 AN	63*
CAP 10 CP229	185	CAV 06 L21	178	CC 1.5 AN	63*
CAP 10 CP29	185	CAV 06 L29	178	CC 2.5 AN	63*

* These items are also shown in various sections throughout the catalogue.

Part Nos. index



Part No.	page	Part No.	page	Part No.	page
CCEF 06	86	CDAM 16 XN.....	70	CFO 06 L29.....	178
CCEF 10	88	CDCF 10	67	CFO 32	228
CCEF 16	90-94	CDCF 16	69-71	CFO 32.29.....	228
CCEF 16 N	94	CDCF 16 N	71	CFO 32.42.....	228
CCEF 24	92-96	CDCM 10.....	67	CFO 32 L.....	228
CCEF 24 N	96	CDCM 16	69-71	CFO 32 X	229
CCEM 06.....	86	CDCM 16 N.....	71	CFO 48 L.....	232
CCEM 10.....	88	CDDF 108	58-60	CFO 48 L29.....	232
CCEM 16	90-94	CDDF 108 N	60	CFO 48 L42.....	232
CCEM 16 N	94	CDDF 24	53	CFO 50.21.....	172
CCEM 24	92-96	CDDF 38	54-57	CFO 50.29.....	172
CCEM 24 N	96	CDDF 42	55	CFO 50 X	173
CCES	296-300-304-306	CDDF 72	56-59	CFO 50 X29	173
CCFA 0.5	63*	CDDF 72 N	59	CFV 06 L21.....	178
CCFA 0.7	63*	CDDM 108	58-60	CFV 06 L29.....	178
CCFA 1.0	63*	CDDM 108 N.....	60	CFV 06 LG21	178
CCFA 1.5	63*	CDDM 24	53	CFV 06 LG29	178
CCFA 2.5	63*	CDDM 38	54-57	CFV 10.213.....	236
CCFA 3.0	67*	CDDM 42.....	55	CFV 10 G	187
CCFA 4.0	64*	CDDM 72	56-59	CFV 10 G29	187
CCFC 0,5	265*	CDDM 72 N.....	59	CFV 10 LG21	187
CCFD 0.5	63*	CDF 07	39	CFV 10 LG29	187
CCFD 0.7	63*	CDF 07 N	39	CFV 16.216.....	236
CCFD 1.0	63*	CDF 08	40	CFV 16.221.....	236
CCFD 1.5	63*	CDF 15	41	CFV 16 G	200
CCFD 2.5	63*	CDF 25	42-44	CFV 16 G29	200
CCFD 3.0	67*	CDF 25 Z	44	CFV 16 LG21	200
CCFD 4.0	64*	CDF 40.....	43-46	CFV 16 LG29	200
CCFF 0,5	265*	CDF 64.....	45-47	CFV 24.221.....	236
CCINA	296-300-304-306	CDFA 0.3	39-286-287*	CFV 24 G	215
CCMA 0.5	63*	CDFA 0.5	39-286-287*	CFV 24 G29	215
CCMA 0.7.....	63*	CDFA 0.7	39-286-287*	CFV 24 LG21	215
CCMA 1.0.....	63*	CDFA 1.0	39-286-287*	CFV 24 LG29	215
CCMA 1.5.....	63*	CDFA 1.5	39-286-287*	CFV 32	228
CCMA 2.5.....	63*	CDFA 2.5	39-286-287*	CFV 32.29	228
CCMA 3.0.....	67*	CDFA 6A	264	CFV 32.42	228
CCMA 4.0.....	64*	CDFD 0.3.....	39-286-287*	CFV 32 G	228
CCMC 0,5	265*	CDFD 0.5.....	39-286-287*	CFV 32 G29	228
CCMD 0.5	63*	CDFD 0.7.....	39-286-287*	CFV 32 G42	228
CCMD 0.7	63*	CDFD 1.0.....	39-286-287*	CFV 32 L.....	228
CCMD 1.0	63*	CDFD 1.5.....	39-286-287*	CFV 32 LG	228
CCMD 1.5	63*	CDFD 2.5.....	39-286-287*	CFV 32 X.....	229
CCMD 2.5	63*	CDFD 6A	264	CFV 48 L	232
CCMD 3.0	67*	CDM 07	39	CFV 48 L29.....	232
CCMD 4.0	64*	CDM 07 N	39	CFV 48 L42.....	232
CCMF 0,5	265*	CDM 08	40	CFV 50.21	172
CCPNP	296-304-306	CDM 15	41	CFV 50.29	172
CCPNP RN	300	CDM 25	42-44	CFV 50 G29	172
CCPR RN	296-300-304-306	CDM 25 Z	44	CFV 50 X.....	173
CCPZ MIL	296	CDM 40	43-46	CFV 50 X29.....	173
CCPZP	304	CDM 64	45-47	CG 06 FL.....	252
CCPZPA	306	CDMA 0.3	39-286-287*	CG 10 FL.....	252
CCPZ RN	300	CDMA 0.5	39-286-287*	CG 16 FL.....	252
CCSPZP	304	CDMA 0.7	39-286-287*	CG 24 FL.....	252
CCTP 10	296-304	CDMA 1.0	39-286-287*	CGC 06	249
CCTP 16	296-304	CDMA 1.5	39-286-287*	CGC 06 B	251
CCTPACF	306	CDMA 2.5	39-286-287*	CGC 10	249
CCTPACM.....	306	CDMA 6A.....	264	CGC 10 B	251
CCTPADF	306	CDMD 0.3.....	39-286-287*	CGC 16	249
CCTPADM.....	306	CDMD 0.5	39-286-287*	CGC 16 B	251
CCVPP	304	CDMD 0.7	39-286-287*	CGC 24	249
CDAF 10	66	CDMD 1.0	39-286-287*	CGC 24 B	251
CDAF 10 X	66	CDMD 1.5	39-286-287*	CGD 16 C	302
CDAF 16	68-70	CDMD 2.5	39-286-287*	CGD 25 C	302
CDAF 16 N	70	CDMD 6A	264	CGD 35 C	302
CDAF 16 X.....	68-70	CFF 10	186	CGFA 16	137
CDAF 16 XN	70	CFF 10	200	CGFA 25	137
CDAM 10.....	66	CFF 16.221.....	236	CGFA 35	137
CDAM 10 X	66	CFF 24.21	214	CGI 06	248
CDAM 16	68-70	CFF 24.29	214	CGI 06 B	250
CDAM 16 N.....	70	CFF 24.221	236	CGI 10	248
CDAM 16 X	68-70	CFO 06 L21.....	178	CGI 10 B	250

* These items are also shown in various sections throughout the catalogue

Part No.	page	Part No.	page	Part No.	page
CGI 16	248	CHC 06 LC	179	CHI 24 C	212
CGI 16 B	250	CHC 06 LG	179	CHI 24 CP	212
CGI 24	248	CHC 10	188-193	CHI 24 CS	212
CGI 24 B	250	CHC 10 C	188-193	CHI 24 L	212
CGK I	246	CHC 10 G	188-193	CHI 24 LS	212
CGK IA	246	CHC 10 L	188-193	CHI 24 YC	242
CGK IAP13	246	CHC 10 LG	188-193	CHI 32	226
CGK V13	247	CHC 16	202-207	CHI 32 CS	226
CGMA 16	137	CHC 16 C	202-207	CHI 32 L	226
CGMA 25	137	CHC 16 G	202-207	CHI 32 LS	226
CGMA 35	137	CHC 16 L	202-207	CHI 48 L	232
CGO 06.16	249	CHC 16 LG	202-207	CHI 48 LS	232
CGO 06.16 B	251	CHC 24	216-221	CHI 50	171
CGO 06.21	249	CHC 24 C	216-221	CHI 50 CS	171
CGO 06.21 B	251	CHC 24 G	216-221	CHIR 10	194
CGO 06.29	249	CHC 24 L	216-221	CHIR 16	208
CGO 06.29 B	251	CHC 24 LG	216-221	CHIR 24	222
CGO 10.16	249	CHC 32	229	CHIR 48 LS	233
CGO 10.16 B	251	CHC 32 C	229	CHIS 06 L	182
CGO 10.21	249	CHC 32 G	229	CHIS 10	196
CGO 10.21 B	251	CHC 32 L	229	CHIS 16	210
CGO 10.29	249	CHC 32 LG	229	CHIS 24	224
CGO 10.29 B	251	CHC 50	173	CHIW 06 L	181
CGO 16.21	249	CHC 50 G	173	CHIW 10	195
CGO 16.21 B	251	CHCR 06 L	180	CHIW 16	209
CGO 16.29	249	CHCR 10	194	CHIW 24	223
CGO 16.29 B	251	CHCR 10 G	194	CHIW 32	230
CGO 16.36	249	CHCR 16	208	CHIW 48 LS	234
CGO 16.36 B	251	CHCR 16 G	208	CHIW 50	174
CGO 24.21	249	CHCR 24	222	CHO 06 L13	178
CGO 24.21 B	251	CHCR 24 G	222	CHO 06 L16	178
CGO 24.29	249	CHCS 06 L	182	CHO 06 LX16	179
CGO 24.29 B	251	CHCS 06 LG	182	CHO 10	186
CGO 24.36	249	CHCS 10	196	CHO 10 L	186
CGO 24.36 B	251	CHCS 10 G	196	CHO 10 X	188
CGP 06.29	248	CHCS 16	210	CHO 16	200
CGP 10.29	248	CHCS 16 G	210	CHO 16 L	200
CGP 16.36	248	CHCS 24	224	CHO 16 X	202
CGP 24.236	248	CHCS 24 G	224	CHO 24	214
CGP 24.36	248	CHCW 06 L	181	CHO 24 L	214
CGPZ	302	CHCW 06 LG	181	CHO 24 X	216
CGPZ VLG	302	CHCW 10	195	CHO 32	228
CGV 06.16	249	CHCW 10 G	195	CHO 32 L	228
CGV 06.16 B	251	CHCW 16	209	CHO 32 X	229
CGV 06.21	249	CHCW 16 G	209	CHO 32.29	228
CGV 06.21 B	251	CHCW 24	223	CHO 32.42	228
CGV 06.29	249	CHCW 24 G	223	CHO 48 L	232
CGV 06.29 B	251	CHCW 32	230	CHO 48 L29	232
CGV 10.16	249	CHCW 32 G	230	CHO 48 L42	232
CGV 10.16 B	251	CHCW 50	174	CHO 50	172
CGV 10.21	249	CHCW 50 G	174	CHO 50 X	173
CGV 10.21 B	251	CHI 06 L	176	CHOR 06 L13	180
CGV 10.29	249	CHI 06 LC	176	CHOR 10	194
CGV 10.29 B	251	CHI 06 LCP	176	CHOR 16	208
CGV 16.21	249	CHI 06 LCS	176	CHOR 24	222
CGV 16.21 B	251	CHI 06 LS	176	CHOR 48 L	233
CGV 16.221	249	CHI 06 YC	242	CHOS 16	210
CGV 16.221 B	251	CHI 10	184	CHOS 24	224
CGV 16.29	249	CHI 10 C	184	CHOW 16	209
CGV 16.29 B	251	CHI 10 CP	184	CHOW 24	223
CGV 16.36	249	CHI 10 CS	184	CHOW 32	230
CGV 16.36 B	251	CHI 10 L	184	CHOW 48 L	233
CGV 24.21	249	CHI 10 LS	184	CHOW 50	174
CGV 24.21 B	251	CHI 10 YC	242	CHP 06 L	177
CGV 24.229	249	CHI 16	198-240-241	CHP 06 L2	177
CGV 24.229 B	251	CHI 16 C	198-241	CHP 06 LS	177
CGV 24.29	249	CHI 16 CP	198-241	CHP 06 LS2	177
CGV 24.29 B	251	CHI 16 CS	198-241	CHP 10	185
CGV 24.36	249	CHI 16 L	198-241	CHP 10 CP	185
CGV 24.36 B	251	CHI 16 LS	198-241	CHP 10 CP2	185
CGT 16	137	CHI 16 YC	242	CHP 10 CS	185
CHC 06 L	179	CHI 24	212-240	CHP 10 CS2	185

Part No.	page	Part No.	page	Part No.	page
CHP 10 L	185	CHV 16 LG	200	CKAS 03 V	158
CHP 10 L2	185	CHV 16 X	202	CKAS 03 VA	158
CHP 10 LS	185	CHV 24	214	CKAW 03 V	157
CHP 10 LS2	185	CHV 24 G	215	CKAW 03 VA	157
CHP 10.2	185	CHV 24 L	214	CKAX 03 APS	155
CHP 16	199	CHV 24 L29	214	CKAX 03 CX	156
CHP 16 CP	199	CHV 24 LG	215	CKAX 03 CXA	156
CHP 16 CP2	199	CHV 24 X	216	CKAX 03 I	155-290
CHP 16 CS	199	CHV 24.29	214	CKAX 03 IA	155
CHP 16 CS2	199	CHV 32	228	CKAX 03 IAPS	155
CHP 16 L	199	CHV 32 G	228	CKAX 03 VGS	156
CHP 16 L2	199	CHV 32 G29	228	CKAXS 03 AP	158
CHP 16 LS	199	CHV 32 G42	228	CKAXS 03 I	158
CHP 16 LS2	199	CHV 32 L	228	CKAXS 03 IA	158
CHP 16.2	199	CHV 32 LG	228	CKAXS 03 IAP	158
CHP 24	213	CHV 32 X	229	CKAXS 03 VG	158
CHP 24 CP	213	CHV 32.29	228	CKAXW 03 AP	157
CHP 24 CP2	213	CHV 32.42	228	CKAXW 03 I	157
CHP 24 CS	213	CHV 48 L	232	CKAXW 03 IA	157
CHP 24 CS2	213	CHV 48 L29	232	CKAXW 03 IAP	157
CHP 24 L	213	CHV 48 L42	232	CKAXW 03 VG	157
CHP 24 L2	213	CHVR 06 L13	180	CKF 03	36
CHP 24 LS	213	CHVR 10	194	CKF 03 N	36
CHP 24 LS2	213	CHVR 16	208	CKF 04	36
CHP 24.2	213	CHVR 24	222	CKF 04 N	36
CHP 32	227	CHVR 48 L	233	CKG 03 CN	288
CHP 32 L	227	CHVS 16	210	CKG 03 VAN	289
CHP 32 L2	227	CHVS 24	224	CKG 03 VN	289
CHP 32 L229	227	CHVW 16	209	CKM 03	36
CHP 32 L242	227	CHVW 24	223	CKM 03 N	36
CHP 32 L29	227	CHVW 24 G	223	CKM 03 T1	272
CHP 32 L42	227	CHVW 32	230	CKM 03 T2	272
CHP 32 LS	227	CHVW 32 G	230	CKM 03 T3	272
CHP 32 LS2	227	CHVW 48 L	234	CKM 04	36
CHP 32 LS229	227	CIF 2.4	264	CKM 04 N	36
CHP 32 LS242	227	CIF 2.4 A	264	CKR 65	153*
CHP 32 LS29	227	CJ KF	278	CKR 65 D	153*
CHP 32 LS42	227	CJ KM	278	CKSF 03	37
CHP 32.2	227	CJPZ Y	310	CKSM 03	37
CHP 32.229	227	CJST	310	CKSF 04	37
CHP 32.242	227	CK 03 C	154	CKSM 04	37
CHP 32.29	227	CK 03 CA	154	CMAF 03	191
CHP 32.42	227	CK 03 CAN	154	CMAF 06	205
CHP 48 LS	232	CK 03 CN	154	CMAF 16.21	219
CHP 48 LS29	232	CK 03 CX	154	CMAF 16.29	219
CHP 50 CS	171	CK 03 CXA	154	CMAN 16	239
CHP 50 CS2	171	CK 03 CXAN	154	CMAO 03 L21	191
CHP 50 CS229	171	CK 03 CXN	154	CMAO 03 L29	191
CHP 50 CS29	171	CK 03 I	153	CMAO 03 X	193
CHP 50.21	171	CK 03 IA	153	CMAO 03 X29	193
CHP 50.221	171	CK 03 IAN	153	CMAO 03.21	191
CHP 50.229	171	CK 03 IAPNS	153	CMAO 03.29	191
CHP 50.29	171	CK 03 IAPS	153	CMAO 06 L21	205
CHPR 10	194	CK 03 IN	153-288	CMAO 06 L29	205
CHPR 48 LS	233	CK 03 VANS	154	CMAO 06 X	207
CHPW 32	230	CK 03 VAS	154	CMAO 06 X29	207
CHPW 48 LS	234	CK 03 VGNS	154	CMAO 06.21	205
CHPW 50.21	174	CK 03 VGS	154	CMAO 06.29	205
CHPW 50.229	174	CK 03 VNS	154	CMAO 16 L21	219
CHSDS	276	CK 03 VS	154	CMAO 16 L29	219
CHV 06 L13	178	CKA 03 APS	155	CMAO 16 X	221
CHV 06 L16	178	CKA 03 C	156	CMAO 16 X29	221
CHV 06 LG	178	CKA 03 CA	156	CMAO 16.21	219
CHV 06 LX16	179	CKA 03 I	155	CMAO 16.29	219
CHV 10	186	CKA 03 IA	155	CMAO 16.29	219
CHV 10 G	187	CKA 03 IAPS	155	CMAO 16.29	219
CHV 10 L	186	CKA 03 IAPS	155	CMAO 16.29	219
CHV 10 LG	187	CKA 03 VAS	156	CMAO 16.29	219
CHV 10 X	188	CKA 03 VGS	156	CMAO 16.29	219
CHV 16	200	CKA 03 VS	156	CMAO 16.29	219
CHV 16 G	200	CKAG 03 C	290	CMAO 16.29	219
CHV 16 L	200	CKAG 03 V	291	CMAO 16.29	219
		CKAG 03 VA	290	CMAP 03 CP	190
				CMAP 03 CP2	190
				CMAP 03 CP29	190
				CMAP 03 CS	190
				CMAP 03 CS2	190
				CMAP 03 CS29	190
				CMAP 03 L	190
				CMAP 03 L2	190

* These items are also shown in various sections throughout the catalogue

Part No.	page	Part No.	page	Part No.	page
CMAV 03 L229	190	CMAV 16 G	220	CMI 03 LS	189
CMAV 03 L29	190	CMAV 16 G29	220	CMI 06	203
CMAV 03 LS	190	CMAV 16 L21	219	CMI 06 CP	203
CMAV 03 LS2	190	CMAV 16 L29	219	CMI 06 CS	203
CMAV 03 LS29	190	CMAV 16 LG21	220	CMI 06 L	203
CMAV 03.21	190	CMAV 16 LG29	220	CMI 06 LS	203
CMAV 03.221	190	CMAV 16 X	221	CMI 16	217
CMAV 03.229	190	CMAV 16 X29	221	CMI 16 CP	217
CMAV 03.29	190	CMAV 16.21	219	CMI 16 CS	217
CMAV 03CP229	190	CMAV 16.29	219	CMI 16 L	217
CMAV 03CS229	190	CMCEF 03	114	CMI 16 LS	217
CMAV 03LS229	190	CMCEF 06	116-120	CMO 03	191
CMAV 06 CP	204	CMCEF 06 N	120	CMO 03 L	191
CMAV 06 CP2	204	CMCEF 10	118-122	CMO 03 X	193
CMAV 06 CP29	204	CMCEF 10 N	122	CMO 06	205
CMAV 06 CS	204	CMCEF 16	124-125	CMO 06 L	205
CMAV 06 CS2	204	CMCEF 16 N	125	CMO 06 X	207
CMAV 06 CS29	204	CMCEM 03	114	CMO 16	219
CMAV 06 L	204	CMCEM 06	116-120	CMO 16 L	219
CMAV 06 L2	204	CMCEM 06 N	120	CMO 16 X	221
CMAV 06 L229	204	CMCEM 10	118-122	CMP 03	190
CMAV 06 L29	204	CMCEM 10 N	122	CMP 03 CP	190
CMAV 06 LS	204	CMCEM 16	124-125	CMP 03 CP2	190
CMAV 06 LS2	204	CMCEM 16 N	125	CMP 03 CS	190
CMAV 06 LS29	204	CMEF 03 T	115	CMP 03 CS2	190
CMAV 06.21	204	CMEF 03 TX	115	CMP 03 L	190
CMAV 06.221	204	CMEF 06 T	117-121	CMP 03 L2	190
CMAV 06.229	204	CMEF 06 TN	121	CMP 03 LS	190
CMAV 06.29	204	CMEF 06 TX	117-121	CMP 03 LS2	190
CMAV 06CP229	204	CMEF 06 TXN	121	CMP 03.2	190
CMAV 06CS229	204	CMEF 10 T	119-123	CMP 06	204
CMAV 06LS229	204	CMEF 10 TN	123	CMP 06 CP	204
CMAV 16 CP	218	CMEF 10 TX	119-123	CMP 06 CP2	204
CMAV 16 CP2	218	CMEF 10 TXN	123	CMP 06 CS	204
CMAV 16 CP29	218	CMEF 16	124-125	CMP 06 CS2	204
CMAV 16 CS	218	CMEF 16 N	125	CMP 06 L	204
CMAV 16 CS2	218	CMEM 03 T	115	CMP 06 L2	204
CMAV 16 CS29	218	CMEM 03 TX	115	CMP 06 LS	204
CMAV 16 L	218	CMEM 06 T	117-121	CMP 06 LS2	204
CMAV 16 L2	218	CMEM 06 TN	121	CMP 06.2	204
CMAV 16 L229	218	CMEM 06 TX	117-121	CMP 16	218
CMAV 16 L29	218	CMEM 06 TXN	121	CMP 16 CP	218
CMAV 16 LS	218	CMEM 10 T	119-123	CMP 16 CP2	218
CMAV 16 LS2	218	CMEM 10 TN	123	CMP 16 CS	218
CMAV 16 LS29	218	CMEM 10 TX	119-123	CMP 16 CS2	218
CMAV 16.21	218	CMEM 10 TXN	123	CMP 16 L	218
CMAV 16.221	218	CMEM 16	124-125	CMP 16 L2	218
CMAV 16.229	218	CMEM 16 N	125	CMP 16 LS	218
CMAV 16.29	218	CMFF 03	191	CMP 16 LS2	218
CMAV 16CP229	218	CMFF 16.21	219	CMP 16.2	218
CMAV 16CS229	218	CMFF 16.29	219	CMSEF 03	114
CMAV 16LS229	218	CMAF 06	205	CMSEF 06	116-120
CMAV 03 G	192	CMFV 03 G	192	CMSEF 06 N	120
CMAV 03 G29	192	CMFV 03 G29	192	CMSEF 10	118-122
CMAV 03 L21	191	CMFV 03 LG21	192	CMSEF 10 N	122
CMAV 03 L29	191	CMFV 03 LG29	192	CMSEM 03	114
CMAV 03 LG21	192	CMFV 06 G	206	CMSEM 06	116-120
CMAV 03 LG29	192	CMFV 06 G29	206	CMSEM 06 N	120
CMAV 03 X	193	CMFV 06 LG21	206	CMSEM 10	118-122
CMAV 03 X29	193	CMFV 06 LG29	206	CMSEM 10 N	122
CMAV 03.21	191	CMFV 10.220	236	CMV 03	191
CMAV 03.29	191	CMFV 16.220	236	CMV 03 G	192
CMAV 06 G	206	CMFV 16.225	236	CMV 03 L	191
CMAV 06 G29	206	CMFV 16 G	220	CMV 03 LG	192
CMAV 06 L21	205	CMFV 16 G29	220	CMV 03 X	193
CMAV 06 L29	205	CMFV 16 LG21	220	CMV 06	205
CMAV 06 LG21	206	CMFV 16 LG29	220	CMV 06 G	206
CMAV 06 LG29	206	CMFV 24.232	236	CMV 06 L	205
CMAV 06 X	207	CMI 03	189	CMV 06 LG	206
CMAV 06 X29	207	CMI 03 CP	189	CMV 06 X	207
CMAV 06.21	205	CMI 03 CS	189	CMV 16	219
CMAV 06.29	205	CMI 03 L	189	CMV 16 G	220

Part No.	page	Part No.	page	Part No.	page
CMV 16 L	219	COB TSFS	259	CR 25 AD1	275
CMV 16 L29	219	CPES	274	CR 25 AD2	275
CMV 16 LG	220	CPF 06	127-128	CR 25/16	260
CMV 16 X	221	CPF 06 N	128	CR 26 V	268
CMV 16.29	219	CPF 06 RY	127	CR 37 AD	275
CNEF 06 RYT	87	CPM 06	127-128	CR 37 AD1	275
CNEF 06 T	87	CPM 06 N	128	CR 37 AD2	275
CNEF 06 TX	87	CPM 06 RY	127	CR 42 V	268
CNEF 10 RYT	89	CPT 24	274	CR 50 AD	275
CNEF 10 T	89	CQ 08 C	161	CR 50 AD1	275
CNEF 10 TX	89	CQ 08 CA	161	CR 50 AD2	275
CNEF 16 RYT	91	CQ 08 I	160	CR CP	271
CNEF 16 T	91-95	CQ 08 V	160	CR CPA	271
CNEF 16 TN	95	CQ 08 VA	160	CR Q12	271
CNEF 16 TX	91-95	CQ 08 VG	161	CR SP	268
CNEF 16 TXN	95	CQEF 10	74	CR TM-1	273
CNEF 24 RYT	93-97	CQEF 18	75	CR VATG	262
CNEF 24 RYTN	97	CQEF 32	76-78	CR VDTG	262
CNEF 24 T	93-97	CQEF 32 N	78	CR VNTG	262
CNEF 24 TN	97	CQEF 46	77-79	CR VPTG	262
CNEF 24 TX	93-97	CQEF 46 N	79	CRAD	263
CNEF 24 TXN	97	CQEM 10	74	CRAS	263
CNEM 06 RYT	87	CQEM 18	75	CRBF	263
CNEM 06 T	87	CQEM 32	76-78	CRBM	263
CNEM 06 TX	87	CQEM 32 N	78	CRF	270
CNEM 10 RYT	89	CQEM 46	77-79	CRF CX	270
CNEM 10 T	89	CQEM 46 N	79	CRF CX D	270
CNEM 10 TX	89	CQES	296-300-304-306	CRF D	270
CNEM 16 RYT	91	CQF 04/2	65	CRH 24	277
CNEM 16 T	91-95	CQF 05	63	CRIC M3	262
CNEM 16 TN	95	CQF 08	64	CRM	270
CNEM 16 TX	91-95	CQF 12	62	CRM CX	270
CNEM 16 TXN	95	CQM 04/2	65	CRM CX D	270
CNEM 24 RYT	93-97	CQM 05	63	CRM D	270
CNEM 24 RYTN	97	CQM 08	64	CRN 1	238-239
CNEM 24 T	93-97	CQM 12	62	CRN 2	238-239
CNEM 24 TN	97	CQO 24	237	CRN 3	238-239
CNEM 24 TX	93-97	CQV 24	237	CRN P	238-239
CNEM 24 TXN	97	CR 05 CA	266-267-268	CRQ 16	161
CNF 06	80	CR 06 AT	266	CRQ 21	161
CNF 06 RY	80	CR 06 FS	268	CRZ 06	277
CNF 10	81	CR 06 SC	267	CRZ 10	277
CNF 10 RY	81	CR 06 ST	266	CRZ 16	277
CNF 16	82-84	CR 09 AD	275	CRZ 24	277
CNF 16 N	84	CR 09 AD1	275	CSEF 06	87
CNF 16 RY	82	CR 09 AD2	275	CSEF 10	89
CNF 24	83-85	CR 10 AT	266	CSEF 16	91-95
CNF 24 N	85	CR 10 CA	266-267-268	CSEF 16 N	95
CNF 24 RY	83-85	CR 10 FS	268	CSEF 24	93-97
CNF 24 RYN	85	CR 10 SC	267	CSEF 24 N	97
CNM 06	80	CR 10 ST	266	CSEM 06	87
CNM 06 RY	80	CR 15 AD	275	CSEM 10	89
CNM 10	81	CR 15 AD1	275	CSEM 16	91-95
CNM 10 RY	81	CR 15 AD2	275	CSEM 16 N	95
CNM 16	82-84	CR 15/16	260	CSEM 24	93-97
CNM 16 N	84	CR 16 AT	266	CSEM 24 N	97
CNM 16 RY	82	CR 16 FS	268	CSSF 06	98
CNM 24	83-85	CR 16 SC	267	CSSF 10	99
CNM 24 N	85	CR 16 SS	268	CSSF 16	100-102
CNM 24 RY	83	CR 16 ST	266	CSSF 16 N	102
CNM 24 RYN	85	CR 20	269	CSSF 24	101-103
COB 06 BC	258	CR 20 CX	269	CSSF 24 N	103
COB 06 CMS	258	CR 20 CX D	269	CSSM 06	98
COB 10 BC	258	CR 20 D	269	CSSM 10	98
COB 10 CMS	258	CR 24 AT	266	CSSM 16	100-102
COB 16 BC	258	CR 24 ATD	266	CSSM 16 N	102
COB 16 CMS	258	CR 24 FS	268	CSSM 24	101-103
COB 24 BC	258	CR 24 SC	267	CSSM 24 N	103
COB 24 CMS	258	CR 24 SCA	267	CT APE	263
COB L	260	CR 24 ST	266	CTEF 06 L	106
COB TCQ	258	CR 24 SS	268	CTEF 06 R	106
COB TSF	259	CR 25 AD	275	CTEF 10 L	107



Part No.	page	Part No.	page	Part No.	page
CTEF 10 R	107	CX 02 GF	137	CXL SM	286
CTEF 16 L	108	CX 02 GM	137	CXM 12/2	131
CTEF 16 R	108	CX 02 HF	145	CXM 4/0	132
CTEF 24 L	109	CX 02 HM	145	CXM 4/2	132
CTEF 24 R	109	CX 02 JF	148	CXM 4/8	133
CTEM 06 L	106	CX 02 JM	148	CXM 6/36	130
CTEM 06 R	106	CX 02 P	149	CXM 8/24	129
CTEM 10 L	107	CX 02 TF	151	CXMA 1.565*
CTEM 10 R	107	CX 02 TM	150	CXMA 2.565*
CTEM 16 L	108	CX 03 4F	139	CXMA 4.065*
CTEM 16 R	108	CX 03 4M	139	CXMA 6.065*
CTEM 24 L	109	CX 03 P	149	CXPNP	298
CTEM 24 R	109	CX 03 TF	151	CXPZ D	298
CTF 06 L	110	CX 03 TM	150	CXTP 40 F	298
CTF 06 R	110	CX 04 BF	146	CXTP 40 M	298
CTF 10 L	111	CX 04 BM	146	CYG 06H06	254
CTF 10 R	111	CX 4 JM	147-148-278	CYG 06H0606	255
CTF 16 L	112	CX 4/2 JM	147-148-278	CYG 06H06D	254
CTF 16 R	112	CX 4E JM	147-148-278	CYG 06H06D10	255
CTF 24 L	113	CX 04 TF	151	CYG 06H10	254
CTF 24 R	113	CX 04 TM	150	CYG 06H1010	255
CTF 40 L	50	CX 05 SF	143	CYG 06H10D	254
CTF 40 R	50	CX 05 SM	143	CYG 06H10D10	255
CTF 64 L	51	CX 06 CF	140	CYG 8 JF	279
CTF 64 R	51	CX 06 CM	140	CYG 8 JFA	279
CTM 06 L	110	CX 6/2 JM	147-148-278	CYG 8/2 JF	279
CTM 06 R	110	CX 06 TF	151	CYG 8/2 JFA	279
CTM 10 L	111	CX 06 TM	150	CYG 16	241
CTM 10 R	111	CX 08 CF	141	CYR 16.3	240
CTM 16 L	112	CX 08 CM	141	CYR 24.4	240
CTM 16 R	112	CX 8 JF	147-148-278	CZAC 15 L	237
CTM 24 L	113	CX 8 JM	147-148-278	CZAC 25 L	237
CTM 24 R	113	CX 8/2 JF	147-148-278	CZAO 15 L16	163
CTM 40 L	50	CX 12 DF	144	CZAO 15 L21	163
CTM 40 R	50	CX 12 DM	144	CZAO 25 L16	167
CTM 64 L	51	CX 20 CF	142	CZAO 25 L21	167
CTM 64 R	51	CX 20 CM	142	CZAOS 15 L21	165
CTSEF 06 L	106	CX 1.6 PF	149	CZAOS 25 L21	168
CTSEF 06 R	106	CX 1.6 PM	149	CZAOW 15 L21	164
CTSEF 10 L	107	CX 1.6 VC	149	CZAOW 25 L21	168
CTSEF 10 R	107	CX 3.0 PF	149	CZAP 25 L	166
CTSEF 16 L	108	CX 3.0 PM	149	CZAP 25 L2	166
CTSEF 16 R	108	CX 3.0 VC	149	CZAP 25 L21	166
CTSEF 24 L	109	CX 4.0 PF	149	CZAP 25LS221	166
CTSEF 24 R	109	CX 4.0 PM	149	CZAPR 06 L	180
CTSEM 06 L	106	CX 4.0 VC	149	CZAPS 25 L2	168
CTSEM 06 R	106	CX 6.0 PF	149	CZAPW 25 L2	168
CTSEM 10 L	107	CX 6.0 PM	149	CZAV 15 L16	163
CTSEM 10 R	107	CX 6.0 VC	149	CZAV 15 L21	163
CTSEM 16 L	108	CX BES	277	CZAV 25 L16	167
CTSEM 16 R	108	CX CFM	151	CZAV 25 L21	167
CTSEM 24 L	109	CX FM	150	CZAV 25 L216	236
CTSEM 24 R	109	CXES	298-300	CZAVS 15 L21	165
CTSF 40 L	50	CXF 12/2	131	CZAVS 25 L21	168
CTSF 40 R	50	CXF 4/0	132	CZAVW 15 L21	164
CTSF 64 L	51	CXF 4/2	132	CZAVW 25 L21	168
CTSF 64 R	51	CXF 4/8	133	CZC 15 L	163
CTSM 40 L	50	CXF 6/36	130	CZC 15 LG	163
CTSM 40 R	50	CXF 8/24	129	CZC 25 L	167
CTSM 64 L	51	CXFA 1.565*	CZC 25 LG	167
CTSM 64 R	51	CXFA 2.565*	CZCR 06 LG	180
CX 01 BF	146	CXFA 4.065*	CZCS 15 L	165
CX 01 BM	146	CXFA 6.065*	CZCS 15 LG	165
CX 01 JF	147	CXL 2/4 PF	287	CZCS 25 L	168
CX 01 JM	147	CXL 2/4 PM	287	CZCS 25 LG	168
CX 01 T	151	CXL 2/4 PFH	287	CZCW 15 L	164
CX 02 4AF	138	CXL 2/4 PMH	287	CZCW 15 LG	164
CX 02 4AM	138	CXL 2/4 SF	286	CZCW 25 L	168
CX 02 4BF	138	CXL 2/4 SM	286	CZCW 25 LG	168
CX 02 4BM	138	CXL PF	287	CZFO 15 L16	163
CX 02 BF	146	CXL PM	287	CZFO 15 L21	163
CX 02 BM	146	CXL SF	286	CZFO 25 L16	167

* These items are also shown in various sections throughout the catalogue



Part No.	page	Part No.	page	Part No.	page
CZFO 25 L21	167	MAOR 06 L32	180	MAP 24 CS232	213
CZFO 25 L16	167	MAOR 10.32	194	MAP 24 CS240	213
CZFO 15 L21	163	MAOR 16.40	208	MAP 24 CS32	213
CZFO 25 L16	167	MAOR 24.40	222	MAP 24 CS40	213
CZFO 25 L21	167	MAOS 06 L32	182	MAP 24 L232	213
CZFO 25 L216	236	MAOS 10.32	196	MAP 24 L240	213
CZI 15 L	162	MAOS 16.32	210	MAP 24 L32	213
CZI 15 LS	162	MAOS 16.40	210	MAP 24 L40	213
CZI 25 L	166	MAOS 24.32	224	MAP 24 LS232	213
CZI 25 LS	166	MAOS 24.40	224	MAP 24 LS240	213
CZIR 06 L	180	MAOW 06 L32	181	MAP 24 LS32	213
CZIS 15 L	165	MAOW 10.32	195	MAP 24 LS40	213
CZIS 25 L	168	MAOW 16.32	209	MAP 24 YC232	242
CZIW 15 L	164	MAOW 16.40	209	MAP 24.232	213
CZIW 25 L	168	MAOW 24.32	223	MAP 24.240	213
CZO 15 L	163	MAOW 24.40	223	MAP 24.32	213
CZO 25 L	167	MAOW 50.32	174	MAP 24.40	213
CZOS 15 L	165	MAP 06 L232	177	MAPR 10.32	194
CZOS 25 L	168	MAP 06 L240	177	MAPR 24.32	222
CZOW 15 L	164	MAP 06 L32	177	MAPS 06 L32	182
CZOW 25 L	168	MAP 06 L40	177	MAPS 10.32	196
CZP 15 L	162	MAP 06 LS232	177	MAPS 16.32	210
CZP 15 L2	162	MAP 06 LS240	177	MAPS 24.32	223
CZP 15 L21	162	MAP 06 LS32	177	MAPW 06 L32	181
CZP 15 LS221	162	MAP 06 LS40	177	MAPW 10.32	195
CZPR 06 L	180	MAP 06 YC232	242	MAPW 16.32	209
CZPS 15 L2	165	MAP 10 CP232	185	MAPW 24.32	223
CZPW 15 L2	164	MAP 10 CP240	185	MAV 06 L25	178
CZV 15 L	163	MAP 10 CP32	185	MAV 06 L32	178
CZV 25 L	167	MAP 10 CP40	185	MAV 06 LG25	178
CZVS 15 L	165	MAP 10 CS232	185	MAV 06 LG32	178
CZVS 25 L	168	MAP 10 CS240	185	MAV 06 YX25	243
CZVW 15 L	164	MAP 10 CS32	185	MAV 06 YX32	243
CZVW 25 L	168	MAP 10 CS40	185	MAV 10 G25	187
MAF 10.20	186	MAP 10 L232	185	MAV 10 G32	187
MAF 16.225	236	MAP 10 L240	185	MAV 10 L32	186
MAF 16.25	200	MAP 10 L32	185	MAV 10 L40	186
MAF 24.225	236	MAP 10 L40	185	MAV 10 LG25	187
MAF 24.25	214	MAP 10 LS232	185	MAV 10 LG32	187
MAF 24.32	214	MAP 10 LS240	185	MAV 10 X32	188
MAO 06 L25	178	MAP 10 LS32	185	MAV 10 X40	188
MAO 06 L32	178	MAP 10 LS40	185	MAV 10 YX32	243
MAO 06 YX25	243	MAP 10 YC232	242	MAV 10 YX40	243
MAO 06 YX32	243	MAP 10.232	185	MAV 10.220	236
MAO 10 L32	186	MAP 10.240	185	MAV 10.32	186
MAO 10 L40	186	MAP 10.32	185	MAV 10.40	186
MAO 10 X32	188	MAP 10.40	185	MAV 16 G25	200
MAO 10 X40	188	MAP 16 CP232	199	MAV 16 G32	200
MAO 10 YX32	243	MAP 16 CP240	199	MAV 16 L32	200
MAO 10 YX40	243	MAP 16 CP32	199	MAV 16 L40	200
MAO 10.32	186	MAP 16 CP40	199	MAV 16 LG25	200
MAO 10.40	186	MAP 16 CS232	199	MAV 16 LG32	200
MAO 16 L32	200	MAP 16 CS240	199	MAV 16 X32	202
MAO 16 L40	200	MAP 16 CS32	199	MAV 16 X40	202
MAO 16 X32	202	MAP 16 CS40	199	MAV 16 YX32	243
MAO 16 X40	202	MAP 16 L232	199	MAV 16 YX40	243
MAO 16 YX32	243	MAP 16 L240	199	MAV 16.220	236
MAO 16 YX40	243	MAP 16 L32	199	MAV 16.225	236
MAO 16.32	200	MAP 16 L40	199	MAV 16.32	200
MAO 16.40	200	MAP 16 LS232	199	MAV 16.40	200
MAO 24 L32	214	MAP 16 LS240	199	MAV 24 G25	215
MAO 24 L40	214	MAP 16 LS32	199	MAV 24 G32	215
MAO 24 X32	216	MAP 16 LS40	199	MAV 24 L32	200-214
MAO 24 X40	216	MAP 16 YC232	242	MAV 24 L40	200-214
MAO 24 YX32	243	MAP 16.232	199	MAV 24 LG25	215
MAO 24 YX40	243	MAP 16.240	199	MAV 24 LG32	215
MAO 24.32	214	MAP 16.32	199	MAV 24 X32	216
MAO 24.40	214	MAP 16.40	199	MAV 24 X40	216
MAO 50 X25	173	MAP 24 CP232	213	MAV 24 YX32	243
MAO 50 X32	173	MAP 24 CP240	213	MAV 24 YX40	243
MAO 50.25	172	MAP 24 CP32	213	MAV 24.232	236
MAO 50.32	172	MAP 24 CP40	213	MAV 24.32	214

Part No.	page	Part No.	page	Part No.	page
MAV 24.40	214	MFV 32.32	228	MHO 06 L20	178
MAV 50 G32	172	MFV 32.40	228	MHO 06 L25	178
MAV 50 X25	173	MFV 32.50	228	MHO 06 LX20	179
MAV 50 X32	173	MFV 48 L32	232	MHO 06 LX25	179
MAV 50.25	172	MFV 48 L40	232	MHO 10 L20	186
MAV 50.32	172	MFV 48 L50	232	MHO 10 L25	186
MAVR 06 L32	180	MFV 50 G32	172	MHO 10 X20	188
MAVR 10.32	194	MFV 50 X25	173	MHO 10 X25	188
MAVR 16.40	208	MFV 50 X32	173	MHO 10.20	186
MAVR 24.40	222	MFV 50.25	172	MHO 10.25	186
MAVS 06 L32	182	MFV 50.32	172	MHO 16 L25	200
MAVS 10.32	196	MGK IAP20	246	MHO 16 L32	200
MAVS 16.32	210	MGK V20	247	MHO 16 X25	202
MAVS 16.40	210	MGO 06.25	249	MHO 16 X32	202
MAVS 24.32	224	MGO 06.25 B	251	MHO 16.25	200
MAVS 24.40	224	MGO 06.32	249	MHO 16.32	200
MAVW 06 L32	181	MGO 06.32 B	251	MHO 24 L25	214
MAVW 06 LG32	181	MGO 10.25	249	MHO 24 L32	214
MAVW 10 G32	195	MGO 10.25 B	251	MHO 24 X25	216
MAVW 10.32	195	MGO 10.32	249	MHO 24 X32	216
MAVW 16 G32	195-209	MGO 10.32 B	251	MHO 24.25	214
MAVW 16.32	209	MGO 16.32	249	MHO 24.32	214
MAVW 16.40	209	MGO 16.32 B	251	MHO 32 L40	228
MAVW 24.32	223	MGO 16.40	249	MHO 32 X40	229
MAVW 24.40	223	MGO 16.40 B	251	MHO 32.32	228
MAVW 50.32	174	MGO 16.50	249	MHO 32.40	228
MFF 10.20	186	MGO 16.50 B	251	MHO 32.50	228
MFF 16.225	236	MGO 24.32	249	MHO 48 L32	232
MFF 16.25	200	MGO 24.32 B	251	MHO 48 L40	232
MFF 24.225	236	MGO 24.40	249	MHO 48 L50	232
MFF 24.25	214	MGO 24.40 B	251	MHO 50 X25	173
MFF 24.32	214	MGO 24.50	249	MHO 50 X32	173
MFO 06 L25	178	MGO 24.50 B	251	MHO 50.25	172
MFO 06 L32	178	MGP 06.32	248	MHO 50.32	172
MFO 32 L40	228	MGP 10.32	248	MHOR 06 L20	180
MFO 32 X40	229	MGP 16.40	248	MHOR 10.20	194
MFO 32.32	228	MGP 24.240	248	MHOR 16.25	208
MFO 32.40	228	MGP 24.40	248	MHOR 24.25	222
MFO 32.50	228	MGV 06.25	249	MHOR 48 L40	233
MFO 48 L32	232	MGV 06.25 B	251	MHOS 16.25	210
MFO 48 L40	232	MGV 06.32	249	MHOS 16.32	210
MFO 48 L50	232	MGV 06.32 B	251	MHOS 24.25	224
MFO 50 X25	173	MGV 06.40	249	MHOS 24.32	224
MFO 50 X32	173	MGV 06.40 B	251	MHOW 16.25	209
MFO 50.25	172	MGV 10.25	249	MHOW 16.32	209
MFO 50.32	172	MGV 10.25 B	251	MHOW 24.25	223
MFV 06 L25	178	MGV 10.32	249	MHOW 24.32	223
MFV 06 L32	178	MGV 10.32 B	251	MHOW 32.40	230
MFV 06 LG25	178	MGV 10.40	249	MHOW 48 L40	234
MFV 06 LG32	178	MGV 10.40 B	251	MHOW 50.25	174
MFV 10 G25	187	MGV 16.225	249	MHOW 50.32	174
MFV 10 G32	187	MGV 16.225 B	251	MHP 06 L20	177
MFV 10 LG25	187	MGV 16.25	249	MHP 06 L220	177
MFV 10 LG32	187	MGV 16.25 B	251	MHP 06 LS20	177
MFV 10.220	236	MGV 16.32	249	MHP 06 LS220	177
MFV 16 G25	200	MGV 16.32 B	251	MHP 10 CP20	185
MFV 16 G32	200	MGV 16.40	249	MHP 10 CP220	185
MFV 16 LG25	200	MGV 16.40 B	251	MHP 10 CS20	185
MFV 16 LG32	200	MGV 16.50	249	MHP 10 CS220	185
MFV 16.220	236	MGV 16.50 B	251	MHP 10 L20	185
MFV 16.225	236	MGV 24.232	249	MHP 10 L220	185
MFV 24 G25	215	MGV 24.232 B	251	MHP 10 LS20	185
MFV 24 G32	215	MGV 24.240	249	MHP 10 LS220	185
MFV 24 LG25	215	MGV 24.240 B	251	MHP 10.20	185
MFV 24 LG32	215	MGV 24.32	249	MHP 10.220	185
MFV 24.232	236	MGV 24.32 B	251	MHP 16 CP225	199
MFV 32 G32	228	MGV 24.325	249	MHP 16 CP25	199
MFV 32 G40	228	MGV 24.325 B	251	MHP 16 CS225	199
MFV 32 G50	228	MGV 24.40	249	MHP 16 CS25	199
MFV 32 L40	228	MGV 24.40 B	251	MHP 16 L225	199
MFV 32 LG40	228	MGV 24.50	249	MHP 16 L25	199
MFV 32 X40	229	MGV 24.50 B	251	MHP 16 LS225	199



Part No.	page	Part No.	page	Part No.	page
MHP 16 LS25	199	MHV 32 G32	228	MMAO 06 X40	207
MHP 16.225	199	MHV 32 G40	228	MMAO 06.32	205
MHP 16.25	199	MHV 32 G50	228	MMAO 06.40	205
MHP 24 CP225	213	MHV 32 L40	228	MMAO 16 L32	219
MHP 24 CP25	213	MHV 32 LG40	228	MMAO 16 L40	219
MHP 24 CS225	213	MHV 32 X40	229	MMAO 16 X32	221
MHP 24 CS25	213	MHV 32.32	228	MMAO 16 X40	221
MHP 24 L225	213	MHV 32.40	228	MMAO 16.32	219
MHP 24 L25	213	MHV 32.50	228	MMAO 16.40	219
MHP 24 LS225	213	MHV 48 L32	232	MMAP 03 CP32	190
MHP 24 LS25	213	MHV 48 L40	232	MMAP 03 CP40	190
MHP 24.225	213	MHV 48 L50	232	MMAP 03 CS32	190
MHP 24.25	213	MHVR 06 L20	180	MMAP 03 CS40	190
MHP 32 L240	227	MHVR 10.20	194	MMAP 03 L232	190
MHP 32 L250	227	MHVR 16.25	208	MMAP 03 L240	190
MHP 32 L40	227	MHVR 24.25	222	MMAP 03 L32	190
MHP 32 L50	227	MHVR 48 L40	233	MMAP 03 L40	190
MHP 32 LS240	227	MHVS 16.25	210	MMAP 03 LS32	190
MHP 32 LS250	227	MHVS 16.32	210	MMAP 03 LS40	190
MHP 32 LS40	227	MHVS 24.25	224	MMAP 03.232	190
MHP 32 LS50	227	MHVS 24.32	224	MMAP 03.240	190
MHP 32.240	227	MHVW 16.25	209	MMAP 03.32	190
MHP 32.250	227	MHVW 16.32	209	MMAP 03.40	190
MHP 32.40	227	MHVW 24 G32	223	MMAP 03CP232	190
MHP 32.50	227	MHVW 24.25	223	MMAP 03CP240	190
MHP 48 LS40	232	MHVW 24.32	223	MMAP 03CS232	190
MHP 48 LS50	232	MHVW 32 G40	230	MMAP 03CS240	190
MHP 50 CS232	171	MHVW 32.40	230	MMAP 03LS232	190
MHP 50 CS240	171	MHVW 48 L40	234	MMAP 03LS240	190
MHP 50 CS32	171	MK IAP20	153	MMAP 06 CP32	204
MHP 50 CS40	171	MK IAPN20	153	MMAP 06 CP40	204
MHP 50.232	171	MK V20	154	MMAP 06 CS32	204
MHP 50.240	171	MK VA20	154	MMAP 06 CS40	204
MHP 50.32	171	MK VAN20	154	MMAP 06 L232	204
MHP 50.40	171	MK VG20	154	MMAP 06 L240	204
MHPR 10.20	194	MK VGN20	154	MMAP 06 L32	204
MHPR 48 LS40	233	MK VN20	154	MMAP 06 L40	204
MHPW 32.50	230	MKA AP20	155	MMAP 06 LS32	204
MHPW 48 LS40	234	MKA IAP20	155	MMAP 06 LS40	204
MHPW 50.250	174	MKA V20	156	MMAP 06.232	204
MHPW 50.32	174	MKA VA20	156	MMAP 06.240	204
MHV 06 L20	178	MKA VG20	156	MMAP 06.32	204
MHV 06 L25	178	MKAG V20	291	MMAP 06.40	204
MHV 06 LG25	178	MKAG VA20	291	MMAP 06CP232	204
MHV 06 LX20	179	MKAS V20	158	MMAP 06CP240	204
MHV 06 LX25	179	MKAS VA20	158	MMAP 06CS232	204
MHV 10 G25	187	MKAW V20	157	MMAP 06CS240	204
MHV 10 L20	186	MKAW VA20	157	MMAP 06LS232	204
MHV 10 L25	186	MKAX AP20	155	MMAP 06LS240	204
MHV 10 LG25	187	MKAX IAP20	155	MMAP 16 CP32	218
MHV 10 X20	188	MKAX VG20	156	MMAP 16 CP40	218
MHV 10 X25	188	MKAXS AP20	158	MMAP 16 CS32	218
MHV 10.20	186	MKAXS IAP20	158	MMAP 16 CS40	218
MHV 10.25	186	MKAXS VG20	158	MMAP 16 L232	218
MHV 16 G32	200	MKAXW AP20	157	MMAP 16 L240	218
MHV 16 L25	200	MKAXW IAP20	157	MMAP 16 L32	218
MHV 16 L32	200	MKAXW VG20	157	MMAP 16 L40	218
MHV 16 LG32	200	MKG VAN20	289	MMAP 16 LS32	218
MHV 16 X25	202	MKG VN20	289	MMAP 16 LS40	218
MHV 16 X32	202	MMAF 03.20	191	MMAP 16.232	218
MHV 16.25	200	MMAF 06.25	205	MMAP 16.240	218
MHV 16.32	200	MMAF 16.25	219	MMAP 16.32	218
MHV 24 G32	215	MMAF 16.32	219	MMAP 16.40	218
MHV 24 L25	214	MMAO 03 L32	191	MMAP 16CP232	218
MHV 24 L32	214	MMAO 03 L40	191	MMAP 16CP240	218
MHV 24 L40	214	MMAO 03 X32	193	MMAP 16CS232	218
MHV 24 LG32	215	MMAO 03 X40	193	MMAP 16CS240	218
MHV 24 X25	216	MMAO 03.32	191	MMAP 16LS232	218
MHV 24 X32	216	MMAO 03.40	191	MMAP 16LS240	218
MHV 24.25	214	MMAO 06 L32	205	MMAV 03 G25	192
MHV 24.32	214	MMAO 06 L40	205	MMAV 03 G32	192
MHV 24.40	214	MMAO 06 X32	207	MMAV 03 L32	191



Part No.	page	Part No.	page	Part No.	page
MMAV 03 L40	191	MMP 06 CS25	204	MZFO 15 L20	163
MMAV 03 LG25	192	MMP 06 L225	204	MZFO 15 L25	163
MMAV 03 LG32	192	MMP 06 L25	204	MZFV 25 L20	167
MMAV 03 X32	193	MMP 06 LS225	204	MZFV 25 L25	167
MMAV 03 X40	193	MMP 06 LS25	204	MZFO 25 L20	163
MMAV 03.32	191	MMP 06.225	204	MZFO 25 L25	163
MMAV 03.40	191	MMP 06.25	204	MZFV 25 L20	163
MMAV 06 G25	206	MMP 16 CP225	218	MZFV 25 L220	236
MMAV 06 G32	206	MMP 16 CP25	218	MZFV 25 L25	163
MMAV 06 L32	205	MMP 16 CS225	218	MZO 15 L20	163
MMAV 06 L40	205	MMP 16 CS25	218	MZO 15 L25	163
MMAV 06 LG25	206	MMP 16 L225	218	MZO 25 L20	167
MMAV 06 LG32	206	MMP 16 L25	218	MZO 25 L25	167
MMAV 06 X32	207	MMP 16 LS225	218	MZOS 15 L20	165
MMAV 06 X40	207	MMP 16 LS25	218	MZOS 15 L25	165
MMAV 06.32	205	MMP 16.225	218	MZOS 25 L20	168
MMAV 06.40	205	MMP 16.25	218	MZOS 25 L25	168
MMAV 16 G25	220	MMV 03 G25	192	MZOW 15 L20	164
MMAV 16 G32	220	MMV 03 L20	191	MZOW 15 L25	164
MMAV 16 L32	219	MMV 03 L25	191	MZOW 25 L20	168
MMAV 16 L40	219	MMV 03 LG25	192	MZOW 25 L25	168
MMAV 16 LG25	220	MMV 03 X20	193	MZP 15 L225	162
MMAV 16 LG32	220	MMV 03 X25	193	MZP 15 L25	162
MMAV 16 X32	221	MMV 03.20	191	MZP 15 LS225	162
MMAV 16 X40	221	MMV 03.25	191	MZPR 06 L20	180
MMAV 16.32	219	MMV 06 G32	206	MZPS 15 L225	164
MMAV 16.40	219	MMV 06 L25	205	MZPW 15 L225	164
MMFF 03.20	191	MMV 06 L32	205	MZV 15 L20	163
MMFF 06.25	205	MMV 06 LG32	206	MZV 25 L20	167
MMFF 16.25	219	MMV 06 X25	207	MZVS 15 L20	165
MMFF 16.32	219	MMV 06 X32	207	MZVS 25 L20	168
MMFV 03 G25	192	MMV 06.25	205	MZVW 15 L20	164
MMFV 03 G32	192	MMV 06.32	205	MZVW 25 L20	168
MMFV 06 G25	206	MMV 16 G32	220	SDS	276
MMFV 06 G32	206	MMV 16 L25	219		
MMFV 06 LG25	206	MMV 16 L32	219		
MMFV 06 LG32	206	MMV 16 L40	219		
MMFV 16 G25	220	MMV 16 LG32	220		
MMFV 16 G32	220	MMV 16 X25	221		
MMFV 16 LG25	220	MMV 16 X32	221		
MMFV 16 LG32	220	MMV 16.25	219		
MMO 03 L20	191	MMV 16.32	219		
MMO 03 L25	191	MMV 16.40	219		
MMO 03 X20	193	MQO 24.40	237		
MMO 03 X25	193	MQV 24.40	237		
MMO 03.20	191	MZAO 15 L20	163		
MMO 03.25	191	MZAO 15 L25	163		
MMO 06 L25	205	MZAO 25 L20	167		
MMO 06 L32	205	MZAO 25 L25	167		
MMO 06 X25	207	MZAO 25 L25	167		
MMO 06 X32	207	MZAO 25 L25	167		
MMO 06.25	205	MZAO 25 L25	167		
MMO 06.32	205	MZAO 25 L25	167		
MMO 16 L25	219	MZAO 25 L25	167		
MMO 16 L32	219	MZAO 25 L25	167		
MMO 16 X25	221	MZAO 25 L25	167		
MMO 16 X32	221	MZAO 25 L25	167		
MMO 16.25	219	MZAO 25 L25	167		
MMO 16.32	219	MZAO 25 L25	167		
MMP 03 CP20	190	MZAO 25 L25	167		
MMP 03 CP220	190	MZAO 25 L25	167		
MMP 03 CS20	190	MZAO 25 L25	167		
MMP 03 CS220	190	MZAO 25 L25	167		
MMP 03 L20	190	MZAO 25 L25	167		
MMP 03 L220	190	MZAO 25 L25	167		
MMP 03 LS20	190	MZAO 25 L25	167		
MMP 03 LS220	190	MZAO 25 L25	167		
MMP 03.20	190	MZAO 25 L25	167		
MMP 03.220	190	MZAO 25 L25	167		
MMP 06 CP225	204	MZAO 25 L25	167		
MMP 06 CP25	204	MZAO 25 L25	167		
MMP 06 CS225	204	MZAO 25 L25	167		
		MZAV 15 L20	163		
		MZAV 15 L25	163		
		MZAV 25 L20	167		
		MZAV 25 L220	236		
		MZAV 25 L25	167		
		MZAVS 15 L25	165		
		MZAVS 25 L25	168		
		MZAVW 15 L25	164		
		MZAVW 25 L25	168		
		MZFO 15 L20	163		
		MZFO 15 L25	163		
		MZFO 25 L20	167		
		MZFO 25 L25	167		



