

Telemecanique Sensors Detection components

Panorama

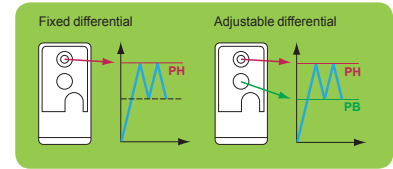
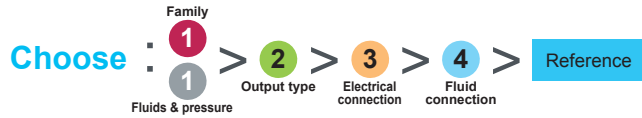

Simply easy!™

Pressure switches: OsiSense XM



XMLA / XMLB Electromechanical		Hydraulic oils, air, fresh water, sea water / Temp. : up to 70° C						
Screw terminal	Bar	psi	1 C/O single pole contact fixed differential			1 C/O single pole contact adjustable differential		
			ISO M20	Pg13	DIN connector	ISO M20	Pg13	DIN connector
	-1	-14.5	XMLAM01V2S12	XMLAM01V2S11	XMLAM01V2C11	XMLBM02V2S12	XMLBM02V2S11	XMLBM02V2C11
	2.5	36.3	XMLA002A2S12	XMLA002A2S11	XMLA002A2C11	XMLB002A2S12	XMLB002A2S11	XMLB002A2C11
	4	58	XMLA004A2S12	XMLA004A2S11	XMLA004A2C11	XMLB004A2S12	XMLB004A2S11	XMLB004A2C11
	10	145	XMLA010A2S12	XMLA010A2S11	XMLA010A2C11	XMLB010A2S12	XMLB010A2S11	XMLB010A2C11
	20	290	XMLA020A2S12	XMLA020A2S11	XMLA020A2C11	XMLB020A2S12	XMLB020A2S11	XMLB020A2C11
	35	508	XMLA035A2S12	XMLA035A2S11	XMLA035A2C11	XMLB035A2S12	XMLB035A2S11	XMLB035A2C11
		Hydraulic oils / Temp. : up to 160° C						
	7	14.5	XMLA001R2S12	XMLA001R2S11	XMLA001R2C11	XMLB001R2S12	XMLB001R2S11	XMLB001R2C11
	10	1015	XMLA070D2S12	XMLA070D2S11	XMLA070D2C11	XMLB070D2S12	XMLB070D2S11	XMLB070D2C11
	160	2320	XMLA160D2S12	XMLA160D2S11	XMLA160D2C11	XMLB160D2S12	XMLB160D2S11	XMLB160D2C11
	300	4350	XMLA300D2S12	XMLA300D2S11	XMLA300D2C11	XMLB300D2S12	XMLB300D2S11	XMLB300D2C11
	500	7250	XMLA500D2S12	XMLA500D2S11	XMLA500D2C11	XMLB500D2S12	XMLB500D2S11	XMLB500D2C11

XMLR Electronic + Display		Hydraulic oils, air, fresh water, refrigerant fluids					
M12 4 pin or 5 pin	Bar	psi	Analogue output		Analogue + 2 switching outputs		
			4...20 mA	0...10 V	PNP - NO/NC programmable		
	-1	-14.5	XMLRM01G0T25	XMLRM01G0T75	XMLRM01G2P25		
	1	14.5	XMLR001G0T25	XMLR001G0T75			
	2.5	35.2	XMLR2D5G0T25	XMLR2D5G0T75			
	10	145	XMLR010G0T25	XMLR010G0T75	XMLR010G2P25		
	16	232	XMLR016G0T25	XMLR016G0T75	XMLR016G2P25		
	25	362	XMLR025G0T25	XMLR025G0T75			
	40	580	XMLR040G0T25	XMLR040G0T75	XMLR040G2P25		
	100	1450	XMLR100G0T25	XMLR100G0T75			
	160	2320	XMLR160G0T25	XMLR160G0T75			
	250	3625	XMLR250G0T25	XMLR250G0T75	XMLR250G2P25		
	400	5800	XMLR400G0T25	XMLR400G0T75	XMLR400G2P25		
	600	8700	XMLR600G0T25	XMLR600G0T75			
		Hydraulic oils, air, fresh water, refrigerant fluids					
	-1	-14.5	XMLRM01G1P25	XMLRM01G1P75	XMLRM01G2P05		
	1	14.5	XMLR001G1P25	XMLR001G1P75	XMLR001G2P05		
	2.5	35.2	XMLR2D5G1P25	XMLR2D5G1P75	XMLR2D5G2P05		
	10	145	XMLR010G1P25	XMLR010G1P75	XMLR010G2P05		
	16	232	XMLR016G1P25	XMLR016G1P75	XMLR016G2P05		
	25	362	XMLR025G1P25	XMLR025G1P75	XMLR025G2P05		
	40	580	XMLR040G1P25	XMLR040G1P75	XMLR040G2P05		
	100	1450	XMLR100G1P25	XMLR100G1P75	XMLR100G2P05		
	160	2320	XMLR160G1P25	XMLR160G1P75	XMLR160G2P05		
	250	3625	XMLR250G1P25	XMLR250G1P75	XMLR250G2P05		
	400	5800	XMLR400G1P25	XMLR400G1P75	XMLR400G2P05		
	600	8700	XMLR600G1P25	XMLR600G1P75	XMLR600G2P05		

Cabling XM			Connectors (female)				PUR pre wired connectors (female)*				PUR Jumper cables			
	M12		straight		elbowed	M12	straight	elbowed	elbowed PNP LED	M12 (female)	straight	elbowed		
(1)	4 pin	XZCC12FDM40B	XZCC12FCM40B			4 pin	2 m	XZCP1141L2	XZCP1241L2	XZCP1340L2	M12 (male)	straight		
(2)	4 pin	XZCC12FDP40B	XZCC12FCP40B				5 m	XZCP1141L5	XZCP1241L5	XZCP1340L5	4 pin	1 m	XZCR1511041C1	XZCR1512041C1
(1)	5 pin	XZCC12FDM50B	XZCC12FCM50B				10 m	XZCP1141L10	XZCP1241L10	XZCP1340L10		2 m	XZCR1511041C2	XZCR1512041C2

(1) Steel ring (2) Plastic ring

* For a PVC cable, add the letter V after the P. Example: XZCPxxxxx become XZCPVxxxxx

Pressure switches: OsiSense XM

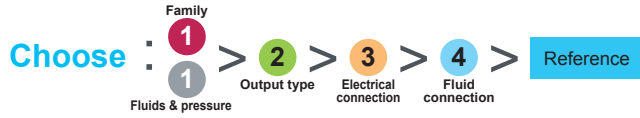

XMLP Electronic transmitter		Hydraulic oils, air, fresh water, refrigerant fluids					
M12 4 pin (male)		-30...+85° C		Analogue output			
		Bar	psi	4...20 mA	0...10 V	0.5...4.5 V	
<p>G 1/4A (male)</p>		-1	-14.5	XMLPM00GD21F	XMLPM00GD71F	XMLPM00GD11F	
		1	14.5	XMLP001GD21F	XMLP001GD71F	XMLP001GD11F	
		6	87	XMLP006GD21F	XMLP006GD71F	XMLP006GD11F	
		10	145	XMLP010BD21V	XMLP010BD71V	XMLP010BD11V	
		16	232	XMLP016BD21V	XMLP016BD71V	XMLP016BD11V	
		25	362	XMLP025BD21V	XMLP025BD71V	XMLP025BD11V	
		40	580	XMLP040BD21V	XMLP040BD71V	XMLP040BD11V	
		60	870	XMLP060BD21V	XMLP060BD71V	XMLP060BD11V	
		100	1450	XMLP100BD22	XMLP100BD72	XMLP100BD12	
		160	2320	XMLP160BD22	XMLP160BD72	XMLP160BD12	
		250	3625	XMLP250BD22	XMLP250BD72	XMLP250BD12	
		400	5800	XMLP400BD22	XMLP400BD72	XMLP400BD12	
		600	8700	XMLP600BD22	XMLP600BD72	XMLP600BD12	

ZMLP Display and switch		4-20 mA analogue + switching output		2 switching outputs	
M12 4 pin (male)		NO/NC Programmable		NO/NC Programmable	
PNP		Window	Hysteresis	Fixed hysteresis	
<p>M12 4 pin (female)</p>		ZMLPA1P2SW	ZMLPA1P2SH	ZMLPA2P0SH	
		<p>Only usable with 4-20mA analogue output XMLP electronic transmitter</p>			
		Quick fixing bracket	Horizontal plan	Vertical plan or pipe	
			XMLPZLH01	XMLPZLV01	

Cabling XM			Connectors (female)			PUR pre wired connectors (female)*			PUR Jumper cables							
			straight		elbowed	straight		elbowed	elbowed PNP LED	M12 (female)		straight	elbowed			
(1)	4 pin	XZCC12FDM40B	XZCC12FCM40B			M12	4 pin	2 m	XZCP1141L2	XZCP1241L2	XZCP1340L2	M12 (female)	4 pin	1 m	XZCR1511041C1	XZCR1512041C1
(2)	4 pin	XZCC12FDP40B	XZCC12FCP40B					5 m	XZCP1141L5	XZCP1241L5	XZCP1340L5	M12 (male)	4 pin	2 m	XZCR1511041C2	XZCR1512041C2
(1)	5 pin	XZCC12FDM50B	XZCC12FCM50B					10 m	XZCP1141L10	XZCP1241L10	XZCP1340L10					

(1) Steel ring (2) Plastic ring

* For a PVC cable, add the letter V after the P. Example: XZCPxxxxx become XZCPVxxxxx

Limit switches: OsiSense XC



Choose: **1** > **2** > **3** > **4** > Reference

Body Head Contact Connection

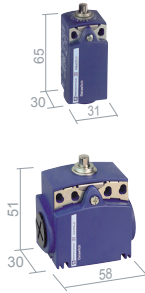

Material	Contact	Body	Head	Connection	Reference			
XCKD Metal	NO+NC Snap	M16	XCKD2110P16	XCKD2102P16	XCKD2121P16	XCKD2106P16	XCKD2118P16	XCKD2145P16
		Pg11	XCKD2110G11	XCKD2102G11	XCKD2121G11	XCKD2106G11	XCKD2118G11	XCKD2145G11
		M12 5P	XCKD2110M12	XCKD2102M12	XCKD2121M12	XCKD2106M12	XCKD2118M12	XCKD2145M12
XCKP Plastic	NO+NC Snap	M16	XCKP2110P16	XCKP2102P16	XCKP2121P16	XCKP2106P16	XCKP2118P16	XCKP2145P16
		Pg11	XCKP2110G11	XCKP2102G11	XCKP2121G11	XCKP2106G11	XCKP2118G11	XCKP2145G11
		M12 4P	XCKP2110M12	XCKP2102M12	XCKP2121M12	XCKP2106M12	XCKP2118M12	XCKP2145M12
XCKT Plastic	NO+NC Snap	M16	XCKT2110P16	XCKT2102P16	XCKT2121P16	XCKT2106P16	XCKT2118P16	XCKT2145P16
		Pg11	XCKT2110G11	XCKT2102G11	XCKT2121G11	XCKT2106G11	XCKT2118G11	XCKT2145G11



Material	Contact	Body	Head	Connection	Reference				
XCMD Metal	NO+NC Snap	1 m	XCMD2110L1	XCMD2102L1	XCMD2124L1	XCMD21F0L1	XCMD21F2L1	XCMD2115L1	XCMD2116L1
	NO+NC Slow	1 m	XCMD2510L1	XCMD2502L1	XCMD2524L1	XCMD25F0L1	XCMD25F2L1	XCMD2515L1	XCMD2516L1
	NO+NC Snap	M12 5P	XCMD2110C12	XCMD2102C12	XCMD2124C12	XCMD21F0C12	XCMD21F2C12	XCMD2115C12	XCMD2116C12
	1 C/O Snap	M12 4P	XCMD2110M12	XCMD2102M12	XCMD2124M12	XCMD21F0M12	XCMD21F2M12	XCMD2115M12	XCMD2116M12



Material	Contact	Body	Head	Connection	Reference		
XCKM Metal	NO+NC Snap	M20	XCKM110H29	XCKM102H29	XCKM121H29	XCKM115H29	XCKM106H29
		Pg11	XCKM110	XCKM102	XCKM121	XCKM115	XCKM106
XCKL Metal	NO+NC Snap	CG	XCKL110	XCKL102	XCKL121	XCKL115	XCKL106

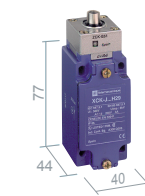

Material	Contact	Body	Head	Connection	Reference			
XCKJ Metal	NO+NC Snap	M20	XCKJ161H29	XCKJ167H29	XCKJ10511H29	XCKJ10513H29	XCKJ10541H29	XCKJ10559H29
		Pg13	XCKJ161	XCKJ167	XCKJ10511	XCKJ10513	XCKJ10541	XCKJ10559
		1/2NPT	XCKJ161H7	XCKJ167H7	XCKJ10511H7	XCKJ10513H7	XCKJ10541H7	XCKJ10559H7
		M12 5P	XCKJ161D	XCKJ167D	XCKJ10511D	XCKJ10513D	XCKJ10541D	XCKJ10559D

(1) Plastic roller (2) Steel roller



Material	Contact	Body	Head	Connection	Reference	
XCSA Metal		M20	NC+2NO Slow	2NC+NO Slow	3NC Slow	Accessories
		Pg13	XCSA502	XCSA702	XCSA802	XCSZ01 XCSZ03
		1/2NPT	XCSA503	XCSA703	XCSA803	



Material	Contact	Body	Head	Connection	Reference			
XCSPA Plastic		M16	NC+NO Slow	2NC Slow	2NO+NC Slow	2NC+NO Slow	2NC+NO Snap	Accessories
		Pg11	XCSPA592	XCSPA792	XCSPA892	XCSPA992	XCSPA492	XCSZ11 XCSZ13
		1/2NPT	XCSPA593	XCSPA793	XCSPA893	XCSPA993	XCSPA493	

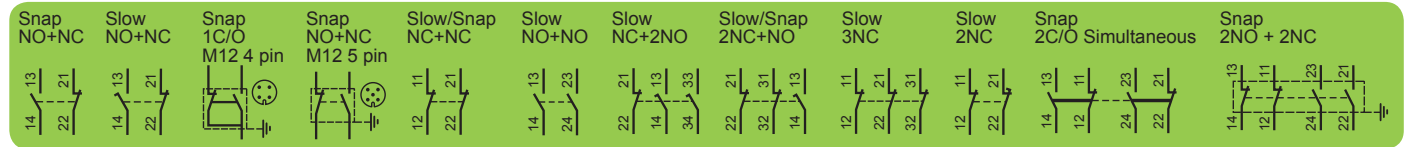

- M16 Tapped M16x1.5 for ISO cable gland
- M20 Tapped M20x1.5 for ISO cable gland
- Pg11 Tapped for a N°11 cable gland
- Pg13 Tapped for a N°13 cable gland
- 1/2NPT Tapped for a 1/2" NPT
- PF1/2 Tapped for a PF1/2"
- M12 5P Connector M12, 5 pin
- M12 4P Connector M12, 4 pin
- CG Tapped with cable gland included

Cabling XC

M12	PUR pre wired connectors (female)*			Connectors (female)			
	straight	elbowed	elbowed PNP LED	M12	straight	elbowed	
4 pin	2 m	XZCP1141L2	XZCP1241L2	XZCP1340L2	(1) 4 pin	XZCC12FDM40B	XZCC12FCM40B
	5 m	XZCP1141L5	XZCP1241L5	XZCP1340L5	(2) 4 pin	XZCC12FDP40B	XZCC12FCP40B
	10 m	XZCP1141L10	XZCP1241L10	XZCP1340L10	(1) 5 pin	XZCC12FDM50B	XZCC12FCM50B
5 pin	5 m	XZCP1164L5	XZCP1264L5				

(1) Steel ring (2) Plastic ring

*For a PVC cable, add the letter V after the P. Example: XZCPxxxxx become XZCPVxxxxx

Limit switches: OsiSense XC



XCKP / XCKD / XCKT

Plastic / Metal / Plastic

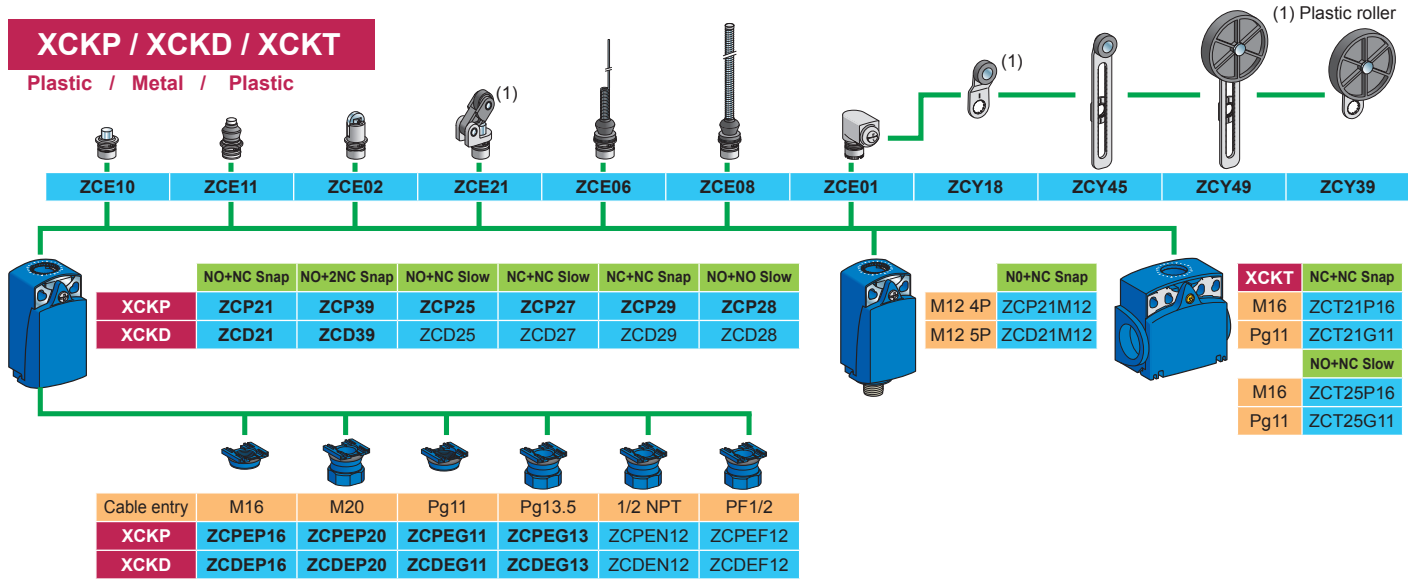

XCMD

Metal

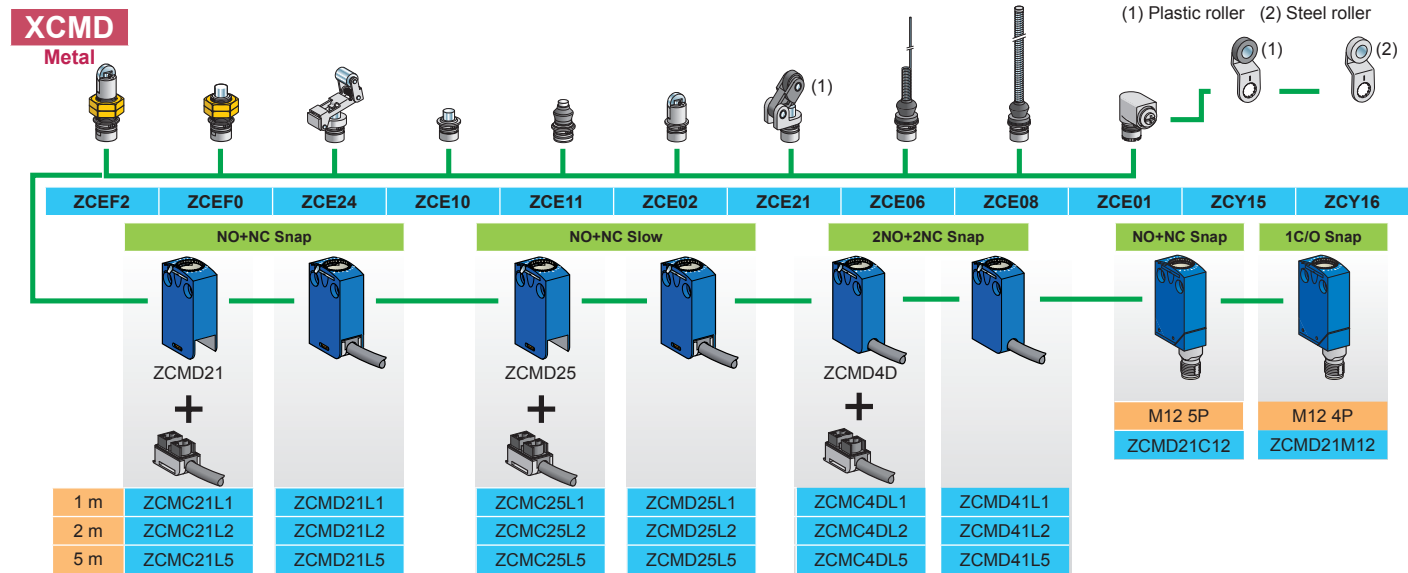

XCMD / XCKL

Metal / Metal

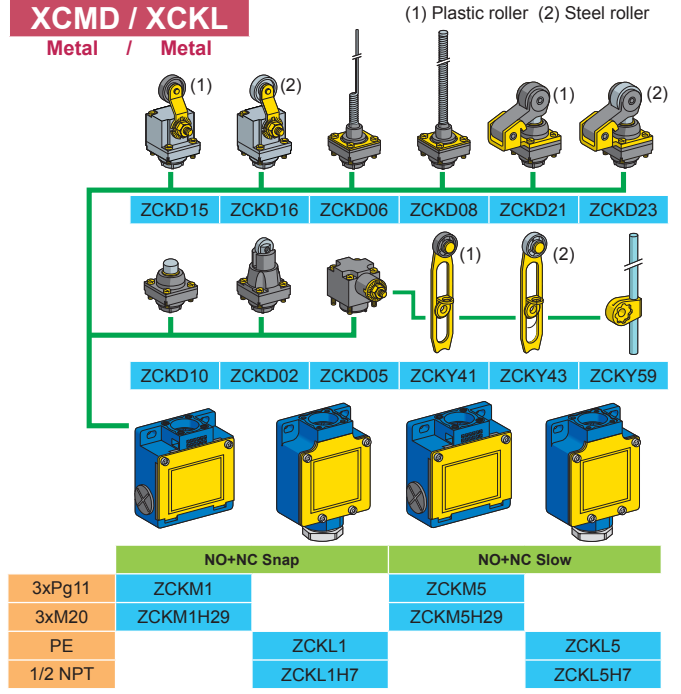

XCKJ

Metal

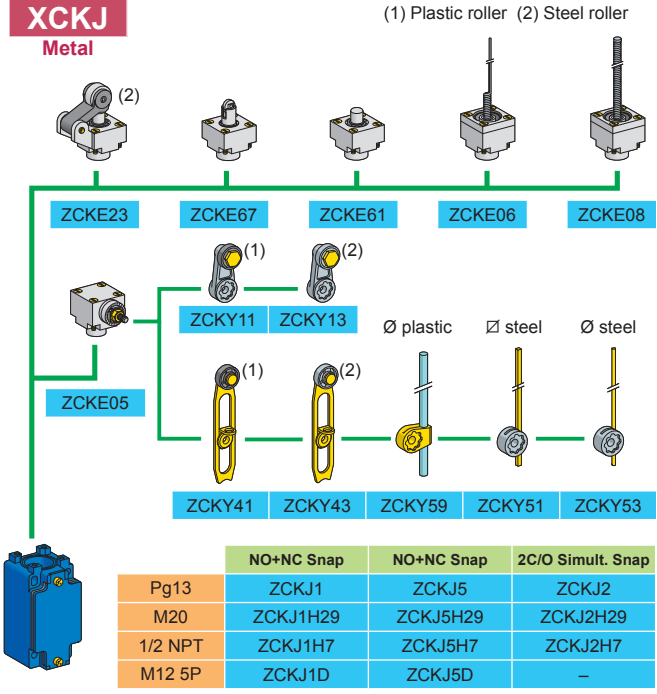

Inductives: OsiSense XS

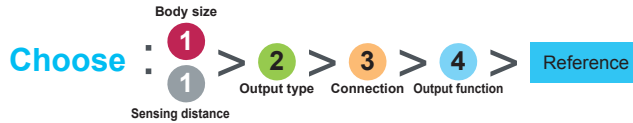

Flush mountable			M8				M12				
			Sensing distance		1.5 mm		2.5 mm		2 mm		4 mm
Short	DC3	PNP	cable	XS508B1P A L2	XS108B3P A L2	XS512B1P A L2	XS112B3P A L2	XS512B1P A M12	XS112B3P A M12	XS512B1N A L2	XS112B3N A L2
			connector	XS508B1P A M8	XS108 B3P A M8	XS512B1N A M12	XS112B3N A M12	XS508B1N A L2	XS108B3N A L2	XS512B1N A M12	XS112B3N A M12
	NPN	cable	XS508B1N A L2	XS108B3N A L2	XS512B1N A L2	XS112B3N A L2	XS508B1N A M8	XS108B3N A M8	XS512B1N A M12	XS112B3N A M12	
		connector	XS508B1N A M8	XS108B3N A M8	XS512B1N A M12	XS112B3N A M12	XS508B1N A M12	XS108B3N A M12	XS512B1N A M12	XS112B3N A M12	
	DC2		cable	XS508B3C A L2	XS608B3C A L2	XS512BSD A L2	XS612B3D A L2	XS508B3C A L01M12	XS608B3C A L01M12	XS512BSD A M12	XS612B3D A M12
			connector	XS508B3C A L01M12	XS608B3C A L01M12	XS512BSD A M12	XS612B3D A M12	XS508B3C A M12	XS608B3C A M12	XS512BSD A M12	XS612B3D A M12
Long	DC3	PNP	cable	XS508BLP A L2	XS608B1P A L2	XS512BLP A L2	XS612B1P A L2	XS508BLP A M12	XS608B1P A M12	XS512BLP A M12	XS612B1P A M12
			connector	XS508BLP A M12	XS608B1P A M12	XS512BLP A M12	XS612B1P A M12	XS508BLN A L2	XS608B1N A L2	XS512BLN A L2	XS612B1N A L2
	NPN	cable	XS508BLN A L2	XS608B1N A L2	XS512BLN A L2	XS612B1N A L2	XS508BLN A M12	XS608B1N A M12	XS512BLN A M12	XS612B1N A M12	
		connector	XS508BLN A M12	XS608B1N A M12	XS512BLN A M12	XS612B1N A M12	XS508B1D A L2	XS608B1D A L2	XS512B1D A L2	XS612B1D A L2	
	DC2		cable	XS508B1D A L2	XS608B1D A L2	XS512B1D A L2	XS612B1D A L2	XS508B1D A M12	XS608B1D A M12	XS512B1D A M12	XS612B1D A M12
			connector	XS508B1D A M12	XS608B1D A M12	XS512B1D A M12	XS612B1D A M12	XS512B1M A L2	XS612B1M A L2	XS512B1M A U20	XS612B1M A U20
AC/DC		cable			XS512B1M A L2	XS612B1M A L2			XS512B1M A U20	XS612B1M A U20	
		connector									
Output function			NO	A						A	
			NC	B						B	



Flush mountable			8x22x8 mm		15x32x8 mm		26x26x13 mm		40x40x15 mm		
			Sensing distance		2.5 mm		5 mm		10 mm		15 mm
Short	DC3	PNP	cable	XS7J1A1P A L2	XS7F1A1P A L2	XS7E1A1P A L2	XS7C1A1P A L2	XS7J1A1P A L01M8	XS7F1A1P A L01M8	XS7E1A1P A M8	XS7C1A1P A M8
			connector	XS7J1A1P A M8	XS7F1A1P A M8	XS7E1A1P A M8	XS7C1A1P A M8	XS7J1A1N A L2	XS7F1A1N A L2	XS7E1A1N A L2	XS7C1A1N A L2
	NPN	cable	XS7J1A1N A L2	XS7F1A1N A L2	XS7E1A1N A L2	XS7C1A1N A L2	XS7J1A1N A L01M8	XS7F1A1N A L01M8	XS7E1A1N A M8	XS7C1A1N A M8	
		connector	XS7J1A1N A M8	XS7F1A1N A M8	XS7E1A1N A M8	XS7C1A1N A M8	XS7J1A1D A L2	XS7F1A1D A L2	XS7E1A1D A L2	XS7C1A1D A L2	
	DC2		cable	XS7J1A1D A L2	XS7F1A1D A L2	XS7E1A1D A L2	XS7C1A1D A L2	XS7J1A1D A L01M8	XS7F1A1D A L01M8	XS7E1A1D A M8	XS7C1A1D A M8
			connector	XS7J1A1D A M8	XS7F1A1D A M8	XS7E1A1D A M8	XS7C1A1D A M8				
Flush adaptable mountable	DC3	PNP	cable			XS8E1A1P A L2	XS8C1A1P A L2				
			connector			XS8E1A1P A M8	XS8C1A1P A M8				
	NPN	cable			XS8E1A1N A L2	XS8C1A1N A L2					
		connector			XS8E1A1N A M8	XS8C1A1N A M8					
	AC/DC		cable			XS8E1A1M A L2	XS8C1A1M A L2				
			connector			XS8E1A1M A L01U20	XS8C1A1M A L01U20				
Output function			NO	A						A	
			NC	B						B	

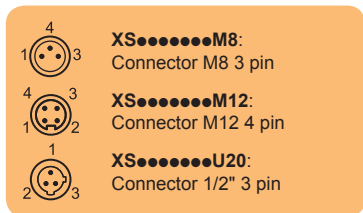

Cabling XS

M8		PUR pre wired connectors (female)*		
		straight	elbowed	
3 pin	2 m	XZCP0566L2	XZCP0666L2	
	5 m	XZCP0566L5	XZCP0666L5	
	10 m	XZCP0566L10	XZCP0666L10	
1/2"	3 pin	5 m	XZCP1865L5	XZCP1965L5

*For a PVC cable, add the letter V after the P. Example: XZCPxxxxx become XZCPVxxxxx

Inductives: OsiSense XS

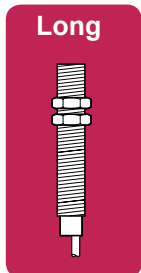

			M18		M30	
			5 mm	8 mm	10 mm	15 mm
DC3	PNP	cable	XS518B1P A L2	XS118B3P A L2	XS530B1P A L2	XS130B3P A L2
		connector	XS518B1P A M12	XS118B3P A M12	XS530B1P A M12	XS130B3P A M12
	NPN	cable	XS518B1N A L2	XS118B3N A L2	XS530B1N A L2	XS130B3N A L2
		connector	XS518B1N A M12	XS118B3N A M12	XS530B1N A M12	XS130B3N A M12
DC2		cable	XS518BSD A L2	XS618B3D A L2	XS530BSD A L2	XS630B3D A L2
		connector	XS518BSD A M12	XS618B3D A M12	XS530BSD A M12	XS630B3D A M12
DC3	PNP	cable	XS518BLP A L2	XS618B1P A L2	XS530BLP A L2	XS630B1P A L2
		connector	XS518BLP A M12	XS618B1P A M12	XS530BLP A M12	XS630B1P A M12
	NPN	cable	XS518BLN A L2	XS618B1N A L2	XS530BLN A L2	XS630B1N A L2
		connector	XS518BLN A M12	XS618B1N A M12	XS530BLN A M12	XS630B1N A M12
DC2		cable	XS518B1D A L2	XS618B1D A L2	XS530B1D A L2	XS630B1D A L2
		connector	XS518B1D A M12	XS618B1D A M12	XS530B1D A M12	XS630B1D A M12
AC/DC		cable	XS518B1M A L2	XS618B1M A L2	XS530B1M A L2	XS630B1M A L2
		connector	XS518B1M A U20	XS618B1M A U20	XS530B1M A U20	XS630B1M A U20
Output function		NO		A	A	A
		NC		B	B	B

Accessories



M8	XSZB108
M12	XSZB112
M18	XSZB118
M30	XSZB130

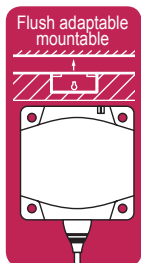
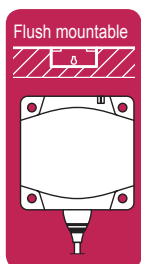

			80x80x26 mm	Cubic	40x40x117 mm	Flush mountable	Non flush mountable
			40 mm			20 mm	40 mm
DC3	PNP	cable	XS7D1A1P A L2		NO+NC	XS8C2A1PCM12	XS8C2A4PCM12
		connector	XS7D1A1P A M12			XS8C2A1NCM12	XS8C2A4NCM12
	NPN	cable	XS7D1A1N A L2		NO	XS8C2A1DAM12	XS8C2A4DAM12
		connector	XS7D1A1N A M12		NO	XS8C2A1MAU20	XS8C2A4MAU20
DC2		cable	XS7D1A1D A L2		NO+NC	XS8C4A1PCP20	XS8C4A4PCP20
	connector	XS7D1A1D A M12	NO+NC			XS8C4A1NCP20	XS8C4A4NCP20
AC/DC		cable	XS8D1A1M A L2		NO or NC	XS8C4A1DPP20	XS8C4A4DPP20
	connector	XS8D1A1M A U20	NO or NC		XS8C4A1MPP20	XS8C4A4MPP20	
Output function		NO					
		NC					

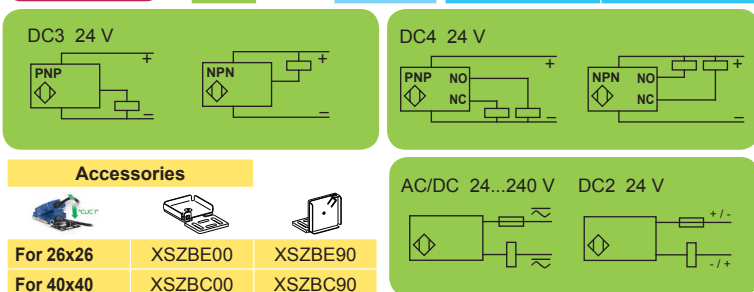

Cabling XS

M12	PUR pre wired connectors (female)*		
	straight	elbowed	elbowed PNP LED
4 pin	2 m	XZCP1141L2	XZCP1241L2 XZCP1340L2
	5 m	XZCP1141L5	XZCP1241L5 XZCP1340L5
	10 m	XZCP1141L10	XZCP1241L10 XZCP1340L10

M12	Connectors (female)	
	straight	elbowed
4 pin	(1) XZCC12FDM40B	XZCC12FCM40B
	(2) XZCC12FDP40B	XZCC12FCP40B

(1) Steel ring (2) Plastic ring

*For a PVC cable, add the letter V after the P. Example: XZCPxxxxx become XZCPVxxxxx

Photo-electrics: OsiSense XU

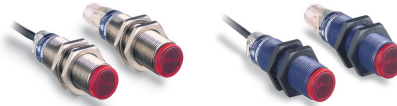
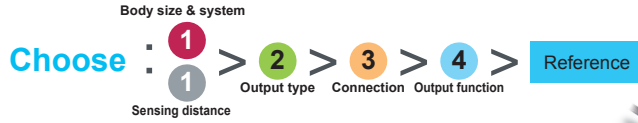

		Sensing distance				M18 metal	M18 plastic	Miniature					
Diffuse 	0.6 m	DC3	PNP	cable	XUB5BP A NL2	XUB5AP A NL2	1 m	XUM5AP C NL2					
				connector 4P	XUB5BP A NM12	XUB5AP A NM12							
		0.1 m	DC3	PNP	cable	XUB5BN A NL2		XUB5AN A NL2		XUM5AN C NL2			
	connector 4P				XUB5BN A NM12	XUB5AN A NM12		XUM5AN C NM8					
	NPN		cable	XUB4BP A NL2	XUB4AP A NL2	5 m		XUM9AP C NL2					
		connector 4P	XUB4BP A NM12	XUB4AP A NM12	XUM9AP C NM8								
cable		XUB4BN A NL2	XUB4AN A NL2	XUM9AN C NL2									
				connector 4P	XUB4BN A NM12	XUB4AN A NM12	XUM9AN C NM8						
				Accessory: Reflector		XUZC50	XUZC50	XUZC50					
Polarized Reflex 	2 m	DC3	PNP	cable	XUB9BP A NL2	XUB9AP A NL2	5 m	XUM9AP C NL2					
				connector 4P	XUB9BP A NM12	XUB9AP A NM12		XUM9AP C NM8					
				NPN	cable	XUB9BN A NL2		XUB9AN A NL2		XUM9AN C NL2			
			connector 4P		XUB9BN A NM12	XUB9AN A NM12		XUM9AN C NM8					
			Accessory: Reflector		XUZC50	XUZC50		XUZC50					
			Reflex 	4 m	DC3	PNP		cable		XUB1BP A NL2	XUB1AP A NL2	5 m	XUM9AP C NL2
connector 4P	XUB1BP A NM12	XUB1AP A NM12					XUM9AP C NM8						
NPN	cable	XUB1BN A NL2					XUB1AN A NL2	XUM9AN C NL2					
	connector 4P	XUB1BN A NM12				XUB1AN A NM12	XUM9AN C NM8						
	Accessory: Reflector					XUZC50	XUZC50	XUZC50					
Thru-beam 	15 m	DC3				PNP	cable	XUB2BP A NL2R	XUB2AP A NL2R	15 m	XUM2AP C NL2R		
			connector 4P	XUB2BP A NM12R	XUB2AP A NM12R		XUM2AP C NM8R						
			NPN	cable	XUB2BN A NL2R		XUB2AN A NL2R	XUM2AN C NL2R					
				connector 4P	XUB2BN A NM12R	XUB2AN A NM12R	XUM2AN C NM8R						
				Accessory: Transmitter		cable	XUB2BKSNL2T	XUB2AKSNL2T	XUM2AK C NL2T				
					connector 4P	XUB2BKSNM12T	XUB2AKSNM12T	XUM2AK C NM8T					
					Output function		NO		A		NO or NC	C	
							NC		B				

Multimode 		DC3	PNP	cable	XUB0BPSNL2	XUB0APSNL2	XUM0APSNL2	
				connector 4P	XUB0BPSNM12	XUB0APSNM12	XUM0APSNM12	
			NPN	cable	XUB0BNSNL2	XUB0ANSNL2	XUM0ANSNL2	
				connector 4P	XUB0BNSNM12	XUB0ANSNM12	XUM0ANSNM12	
		Sensing distance		Background Sup: 0.12 m	Diffuse: 0.3 m	BGS: 0.1 m D: 0.4 m		
		Output function		NO or NC	Polarized reflex: 3 m	Thru-beam: 20 m	P: 3 m TB: 10 m	
Accessory: Transmitter		DC		cable	XUB0BKSNL2T	XUB0AKSNL2T	XUM0AKSNL2T	
				connector 4P	XUB0BKSNM12T	XUB0AKSNM12T	XUM0AKSNM12T	

Reflectors

XUZC24, XUZC80, XUZC50, XUZC100

3D fixings with ball joint

Bracket with ball joint for sensors and reflector XUZC50

Protective housing with ball joint

M12 rod for ball joint

Fixing support for M12 rod

XUB	XUZB2003	XUZK2004
XUM0	XUZM2003	
XUK...	XUZK2003	XUZK2004
XUX...	XUZK2003	
XUB	XUZB2003	XUZ2001
XUM0	XUZM2003	
XUK...	XUZK2003	XUZ2003
XUX...	XUZK2003	

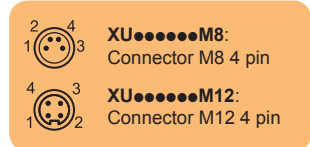

Cabling XU

PUR pre wired connectors (female)*

M8		straight	elbowed
4 pin	2 m	XZCP0941L2	XZCP1041L2
	5 m	XZCP0941L5	XZCP1041L5
	10 m	XZCP0941L10	XZCP1041L10

*For a PVC cable, add the letter V after the P. Example: XZCPxxxxx become XZCPVxxxxx

Photo-electrics: OsiSense XU



		Sensing distance			Compact 50x50 mm				Compact 92x71 mm			
	Diffuse	1 m	DC3	PNP	cable	XUK5AP A NL2	2.1 m	DC3	PNP	terminals	XUX5AP A NT16	
					connector 4P	XUK5AP A NM12				connector 4P	XUX5AP A NM12	
					NPN	cable				XUK5AN A NL2	terminals	XUX5AN A NT16
						connector 4P				XUK5AN A NM12	connector 4P	XUX5AN A NM12
AC/DC	Relay	cable	XUK5ARC NL2	AC/DC	Relay	terminals	XUX5ARC NT16					
		Output function		NO		A			A			
				NC		B			B			
	Polarized Reflex	5 m	DC3	PNP	cable	XUK9AP A NL2	11 m	DC3	PNP	terminals	XUX9AP A NT16	
					connector 4P	XUK9AP A NM12				connector 4P	XUX9AP A NM12	
					NPN	cable				XUK9AN A NL2	terminals	XUX9AN A NT16
						connector 4P				XUK9AN A NM12	connector 4P	XUX9AN A NM12
AC/DC	Relay	cable	XUK9ARC NL2	AC/DC	Relay	terminals	XUX9ARC NT16					
		Accessory: Reflector		XUZC50				XUZC50				
	Reflex	7 m	DC3	PNP	cable	XUK1AP A NL2	14 m	DC3	PNP	terminals	XUX1AP A NT16	
					connector 4P	XUK1AP A NM12				connector 4P	XUX1AP A NM12	
					NPN	cable				XUK1AN A NL2	terminals	XUX1AN A NT16
						connector 4P				XUK1AN A NM12	connector 4P	XUX1AN A NM12
AC/DC	Relay	cable	XUK1ARC NL2	AC/DC	Relay	terminals	XUX1ARC NT16					
		Accessory: Reflector		XUZC50				XUZC50				
	Thru-beam	30 m	DC3	PNP	cable	XUK2AP A NL2R	40 m	DC3	PNP	terminals	XUX2AP A NT16R	
					connector 4P	XUK2AP A NM12R				connector 4P	XUX2AP A NM12R	
					NPN	cable				XUK2AN A NL2R	terminals	XUX2AN A NT16R
						connector 4P				XUK2AN A NM12R	connector 4P	XUX2AN A NM12R
AC/DC	Relay	cable	XUK2ARC NL2R	AC/DC	Relay	terminals	XUX2ARC NT16R					
		Accessory: Transmitter		cable	XUK2AKSNL2T	terminals	XUX0AKSAT16T					
				connector 4P	XUK2AKSNM12T	connector 4P	XUX0AKSAM12T					
				AC/DC	Relay	cable	XUK2ARC NL2T	AC/DC	Relay	terminals	XUX0ARCTT16T	

Multimode		DC3 PNP/NPN		DC3 PNP/NPN					
	Background suppression (BGS)	AC/DC	Relay	cable	XUK0AKSAL2	AC/DC	Relay	terminals	XUX0AKSAT16
				connector 4P	XUK0AKSAM12			connector 4P	XUX0AKSAM12
				cable	XUK0ARCTL2			terminals	XUX0ARCTT16
		Background Suppression: 0.28 m		Diffuse: 0.8 m				Background Suppression: 1.3 m	
		Polarized reflex: 4 m		Thru-beam: 30 m				Polarized reflex: 11 m	
								Thru-beam: 40 m	
Accessory: Transmitter		DC		cable	XUK0AKSAL2T	DC		terminals	XUX0AKSAT16T
				connector 4P	XUK0AKSAM12T			connector 4P	XUX0AKSAM12T
		AC/DC		cable	XUK0ARCTL2T	AC/DC		terminals	XUX0ARCTT16T

Other fixings

	Single bracket	
	standard	with ball joint
XUB	XUZA118 (stainless steel)	XUZA218 (plastic)
XUM	XUZAM02	-
XUK	XUZA51	-
XUX	XUZX2000	-

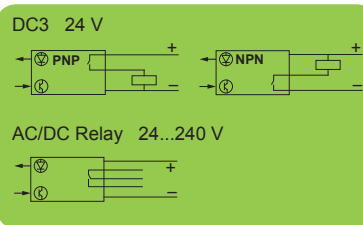

PUR pre wired connectors (female)*					Connectors (female)			
M12		straight	elbowed	elbowed PNP LED	M12	straight	elbowed	
4 pin	2 m	XZCP1141L2	XZCP1241L2	XZCP1340L2	4 pin (1)	XZCC12FDM40B	XZCC12FCM40B	
	5 m	XZCP1141L5	XZCP1241L5	XZCP1340L5		4 pin (2)	XZCC12FDP40B	XZCC12FCP40B
	10 m	XZCP1141L10	XZCP1241L10	XZCP1340L10				

*For a PVC cable, add the letter V after the P. Example: XZCPxxxxx become XZCPVxxxxx

(1) Steel ring (2) Plastic ring

Ultrasonic: OsiSense XX

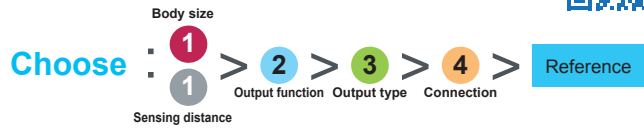

		M12		M18		M18 metal	M30		M30 stainless
Sensing distance		0.05 m	0.1 m	0.15 m	0.5 m Adjust.	0.05 m fixed	1 m Adjust.	8 m Adjust.	1 m Adjust.
Connectors/Cables		M8 4 pin	M8 3 pin	M12 4 pin	M12 4 pin	M12 4 pin	M12 4 pin	M12 4 pin	M12 4 pin
NO	DC4	PNP/NPN	XX512A1KAM8	XX518A1KAM12		XX630A1KAM12			
	DC3	PNP	XX512A2PAM8		XX518A3PAM12 (1)	XXV18B1PAM12	XX6V3A1PAM12 (1)		
		NPN	XX512A2NAM8		XX518A3NAM12 (1)	XX6V3A1NAM12 (1)			
NO+NC	DC4	PNP					XX630A1PCM12	XX630A3PCM12	XX630S1PCM12
		NPN					XX630A1NCM12	XX630A3NCM12	XX630S1NCM12
Analogue	DC4	PNP					XX9V3A1C2M12 (1)	XX930A3A2M12	XX930S1A2M12
		NPN					XX9V3A1F1M12 (1)	XX930A3A1M12	XX930S1A1M12
		4...20 mA					XX9V3A1F1M12 (1)	XX930A3A1M12	XX930S1A1M12
		0...10 V							

(1) Adjustable with XXZPB100

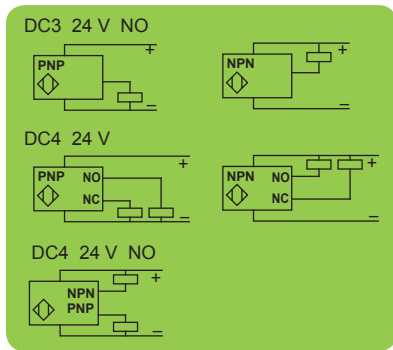

		Flat 7.6x19x33		Flat 16x30x74	Flat 60x30x18 + M18	
Sensing distance		0.1 m		0.25 m	0.5 m Adjust.	0.5 m Adjust.
Connectors		M12 4 pin		M12 4 pin	M12 4 pin	M12 4 pin
NO	DC3	PNP	XX7F1A2PAL01M12	XX7K1A2PAM12	XX7V1A1PAM12 (1)	
		NPN	XX7F1A2NAL01M12	XX7K1A2NAM12	XX7V1A1NAM12 (1)	
Analogue	DC4	4...20 mA				XX9V1A1C2M12 (1)
		0...10 V				XX9V1A1F1M12 (1)

(1) Adjustable with XXZPB100

XUZ 2001	M12	XUZB2012	For XX7K	Flat	XXZ3074F	M12	XXZ12
XUZ 2003	M18	XUZB2003		Cranked	XXZ3074S	M18	XUZA118
	M30	XUZB2030				M30	XXZ30
						XX7F	XXZ1933
						Adjustable	XXZPB100

Forks: OsiSense XUV

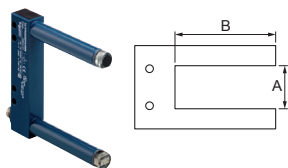

		A: 50 mm / B: 60 mm		A: 80 mm / B: 60 mm		A: 120 mm / B: 120 mm		A: 180 mm / B: 120 mm		
DC3	PNP	M8 3 pin	XUVR0605P	A NM8	XUVR0608P	A NM8	XUVR1212P	A NM8	XUVR1218P	A NM8
	NPN	M8 3 pin	XUVR0605N	A NM8	XUVR0608N	A NM8	XUVR1212N	A NM8	XUVR1218N	A NM8
Output function	NO			A		A		A		A
	NC			B		B		B		B

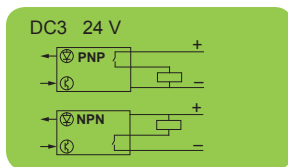

Cabling XX & XUV

		PUR pre wired connectors (female)*			Connectors (female)			
		M8	straight	elbowed	elbowed PNP LED	M12	straight	elbowed
3 pin	2 m	XZCP0566L2	XZCP0666L2			(1) 4 pin	XZCC12FDM40B	XZCC12FCM40B
	5 m	XZCP0566L5	XZCP0666L5			(2) 4 pin	XZCC12FDP40B	XZCC12FCP40B
	10 m	XZCP0566L10	XZCP0666L10					
4 pin	2 m	XZCP0941L2	XZCP1041L2					
	5 m	XZCP0941L5	XZCP1041L5					
	10 m	XZCP0941L10	XZCP1041L10					
M12	4 pin	XZCP1141L2	XZCP1241L2	XZCP1340L2				
	5 m	XZCP1141L5	XZCP1241L5	XZCP1340L5				
	10 m	XZCP1141L10	XZCP1241L10	XZCP1340L10				
					Connectors (male)			
						M12	straight	elbowed
						4 pin	XZCC12MDM40B	XZCC12MCM40B
						5 pin	XZCC12MDM50B	XZCC12MCM50B

(1) Steel ring (2) Plastic ring

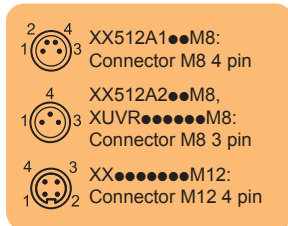

*For a PVC cable, add the letter V after the P. Example: XZCPxxxxx become XZCPVxxxxx

For more information on Detection components, please connect to website: www.tesensors.com



Schneider Electric Industries SAS

Head Office
35, rue Joseph Monier
F-92500 Rueil-Malmaison
France

www.tesensors.com

The information provided in this documentation contains general descriptions and/or technical characteristics of the performance of the products contained herein. This documentation is not intended as a substitute for and is not to be used for determining suitability or reliability of these products for specific user applications. It is the duty of any such user or integrator to perform the appropriate and complete risk analysis, evaluation and testing of the products with respect to the relevant specific application or use thereof. Neither Schneider Electric nor any of its affiliates or subsidiaries shall be responsible or liable for misuse of the information contained herein.

Design: Schneider Electric
Photos: Schneider Electric