



for a greener tomorrow



**MITSUBISHI  
ELECTRIC**

*Changes for the Better*

FACTORY AUTOMATION

# MODULAR PLC FAMILY

MELSEC iQ-R series/System Q/L series



- PLC Control
- Motion
- PC
- Process
- Multi CPU solutions
- Redundancy
- IEC 61131-3
- Networking
- Scalable
- Machine control
- Plant management
- Safety

# Global impact of Mitsubishi Electric



Through Mitsubishi Electric's vision, "Changes for the Better" are possible for a brighter future.

## *Changes for the Better*

We bring together the best minds to create the best technologies. At Mitsubishi Electric, we understand that technology is the driving force of change in our lives. By bringing greater comfort to daily life, maximising the efficiency of businesses and keeping things running across society, we integrate technology and innovation to bring changes for the better.

Mitsubishi Electric is involved in many areas including the following

### **Energy and electric systems**

A wide range of power and electrical products from generators to large-scale displays.

### **Electronic devices**

A wide portfolio of cutting-edge semiconductor devices for systems and products.

### **Home appliance**

Dependable consumer products like air conditioners and home entertainment systems.

### **Information and communication systems**

Commercial and consumer-centric equipment, products and systems.

### **Industrial automation systems**

Maximising productivity and efficiency with cutting-edge automation technology.

# Contents

Global standards	4	
World leading PLCs	5	
Multi platform	6-7	
MELSEC iQ-R series, System Q, L series	8-10	
Safety for all systems	11	
Motion control	12-13	
PC control	14-15	
Process control	16-18	
Programming	19	
Plant solutions	20	
Machine solutions	21	
Your solution partner	23	

Section 2: Technical Information

# Global standards



Through Mitsubishi Electric's vision, "Changes for the better" are possible for a brighter future

## Flexible automation

The MELSEC iQ-R series, MELSEC System Q and MELSEC L series provide global solutions for a vast range of applications. Pioneered by Mitsubishi Electric, these automation systems are modular automation platforms that bring together all features from a variety of different engineering disciplines, including traditional and advanced programmable logic controllers (PLCs), information technology, motion control and process-based control philosophies. Their focus is on boosting productivity, helping users reduce their total cost of ownership while increasing their return on investment.

## Manufactured to the highest standards

Mitsubishi Electric automation products enjoy a global reputation for outstanding quality and reliability. The process starts at the design stage, where quality is designed into even the smallest components. Our systematic pursuit of "best practice" means that Mitsubishi Electric products readily comply with shipping approvals, product directives and standards.

## One of the world's top PLC makers

The Worldwide PLC Survey conducted by the respected American automation research company ARC continues to confirm that Mitsubishi Electric is the world's largest volume producer of PLCs.

ARC is protected by ARC Advisory Group copyright 2004

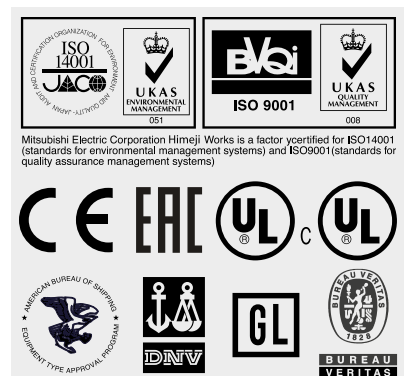

# What makes a world beating modular controller?

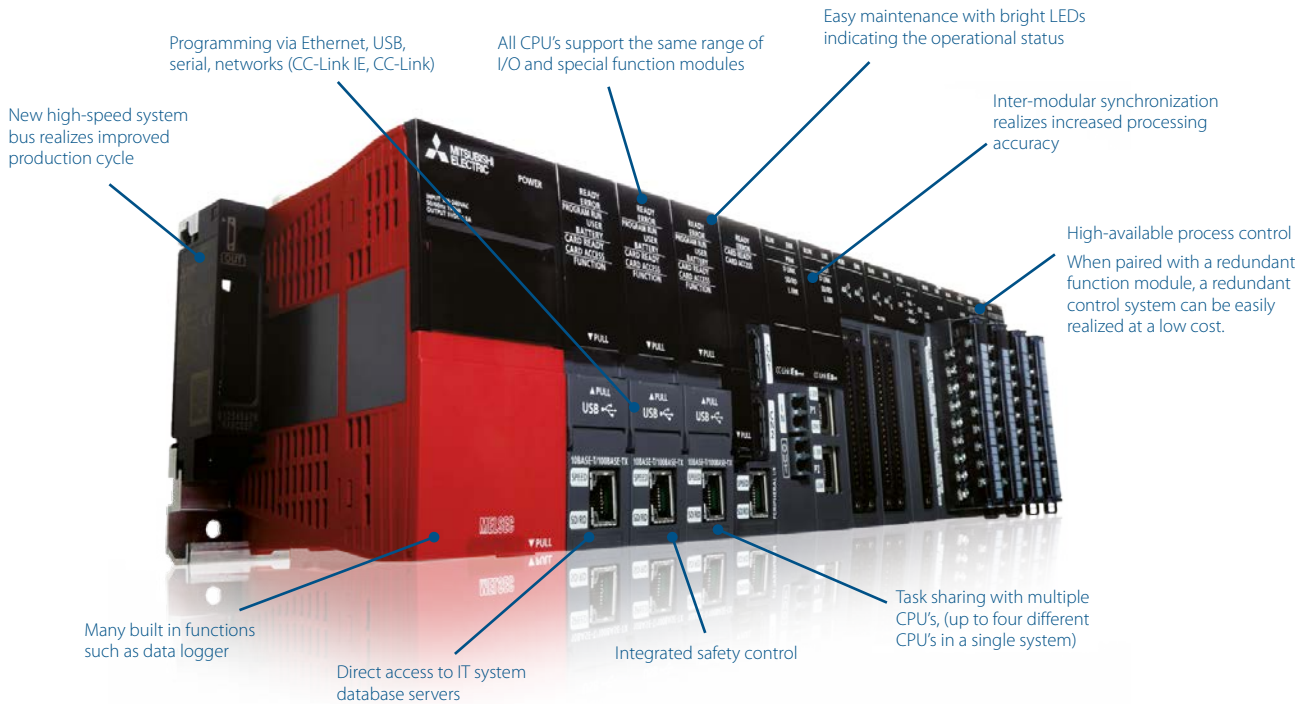

## Global use

The modular PLCs of Mitsubishi Electric will work all over the world. With the large number of marine approvals, compliance with international standards and the stringent requirements of the industry, make the modular PLC a product you can fully trust in.

## Totally scalable

The modular PLCs are designed to grow with your application, from simple standalone solutions to complex network architectures. The concept allows additions and adjustments to your needs at any time.

## Multi CPU

The MELSEC System Q Automation Platform allows you to use multiple CPU's on a single backplane. You can combine up to four CPU types, such as PLC, Motion, PC, C-CPU and Process CPU's, as well as NC and Robots CPU's, as a single seamless solution.

## Multiple connectivity

The modular PLCs of Mitsubishi Electric can communicate easily with Mitsubishi or third party products.

## Flexibility

The wide range of power supplies, CPU's, I/O modules, special function and communication modules make the modular PLCs of Mitsubishi Electric to the most flexible modular automation systems in the world.

## Redundancy

To realize a highly reliable redundant control system, two MELSEC iQ-R series process CPU modules can be combined with a redundant function module each.

For the MELSEC System Q, the redundant Process CPUs Q12/25PRH in combination with standard PLC technology provide a hot standby system with automatic synchronization of data. These modular concepts also allow different degrees of redundancy from power supply and processors to redundant network modules.

# Sophisticated yet simple

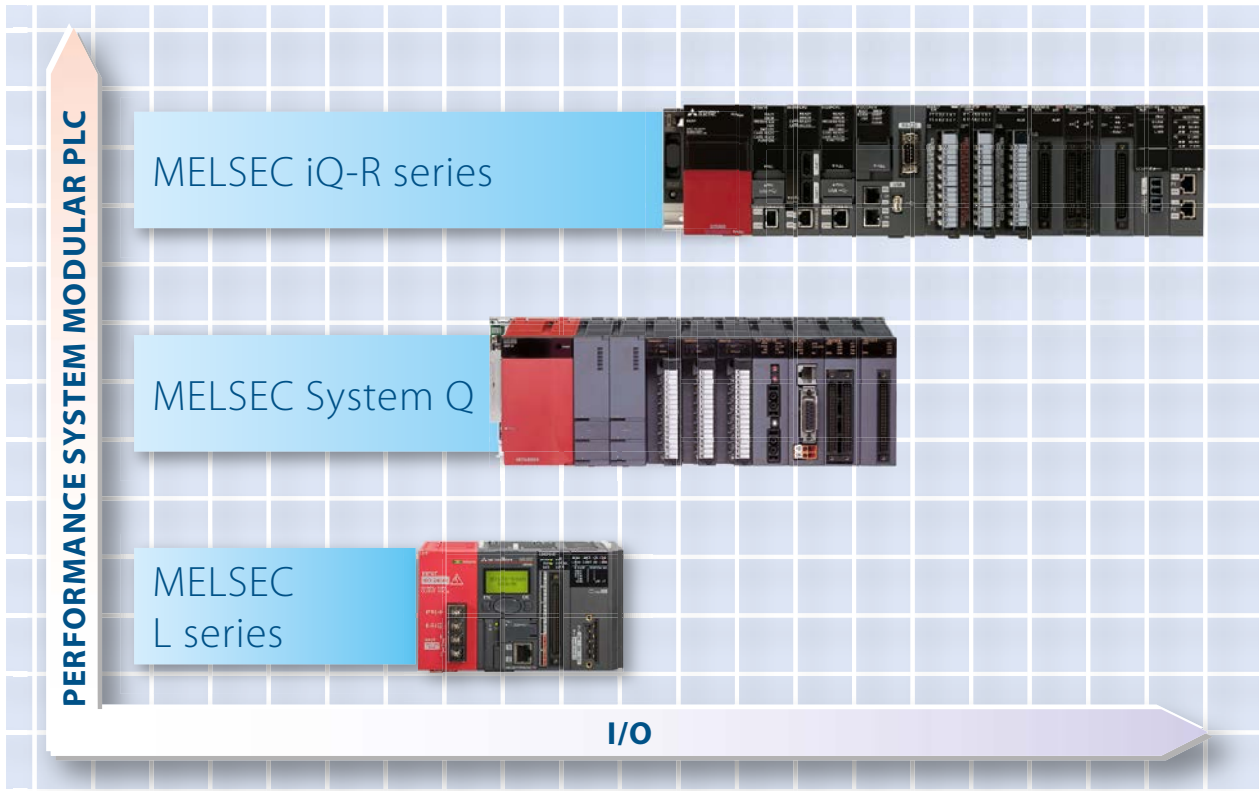

Mitsubishi Electric's modular control solutions span a wide range of capabilities.

## The modular concept

This sophisticated concept of the modular PLCs from Mitsubishi Electric allows users to mix and select the best combination of CPUs, communication devices, special function modules and I/O modules. This allows users to configure systems into what they need, when they need it, where they need it.

## Multiple capabilities

The MELSEC System Q allows to combine basic and advanced PLC CPUs, specialist motion and process controllers and even PC CPUs (industrial PCs) into a single System Q solution with up to four different CPU modules.

The concept of the MELSEC L series requires no rack and is ideal for medium-sized control applications. Using a simple motion module, up to 16 servo axes can be controlled here too.

This range of options gives the user a wide range of control philosophies, programming concepts and languages.

The MELSEC iQ-R series enables total integration of control and communications from a single, highly scalable hardware platform, capable of handling anything from a handful of I/O up to several thousand. Integrated safety control, a vast range of integrated functions as well as high-available process control make it the core for next-generation automation environment.

# Flexible and scalable

## An automation platform for the future

Flexibility and scalability are the key design features that enable the modular PLCs to be a truly powerful automation platform. Users can apply simple control to an individual machine or integrated plant wide management all from the same hardware base.

The modular PLC is supported by several software tools which enable easy and comprehensive integration using Mitsubishi Electric's EZSocket middleware. In addition, Mitsubishi Electric also offer software tools that comply with international standards such as IEC 61131-3, OPC and Active X. This tremendous flexibility permits users to reduce development time, simplify commissioning, and provide ongoing system maintenance.

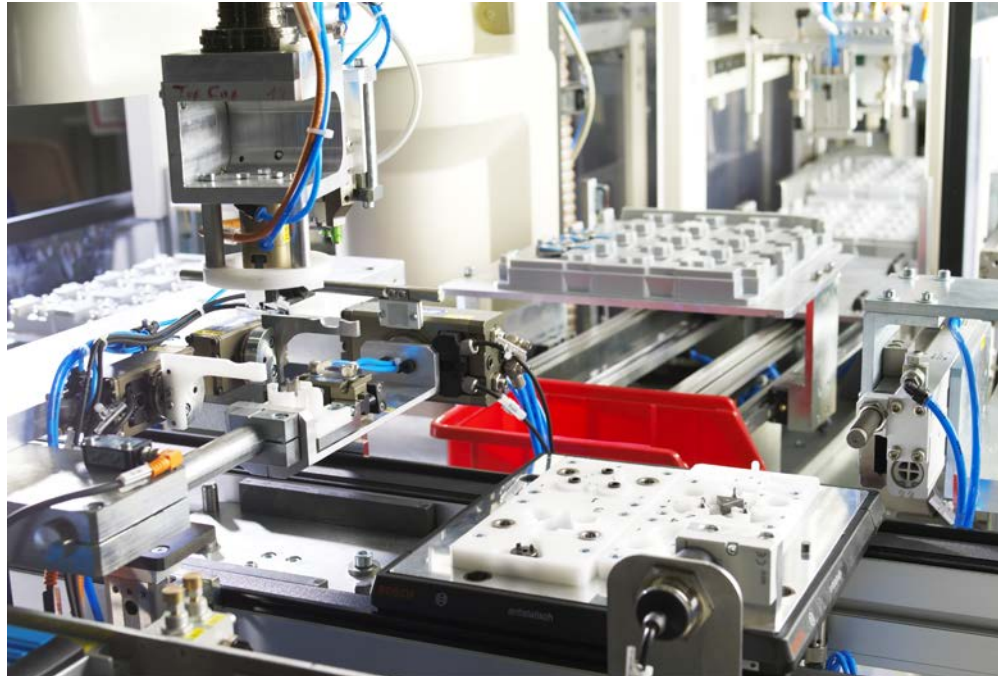

Reliable and secure switching performance even in complex high-power systems

## Proven technology

Experience and expertise have made Mitsubishi Electric one of the world's largest manufacturers of programmable logic controllers. PLC systems from Mitsubishi Electric are forerunners in new technologies and are distinguished by exceptional reliability and performance.

However, Mitsubishi Electric is not only a major provider of automation solutions. As is all too frequently forgotten, being one of the largest manufacturing companies in the Japanese and Asiatic economy, it is itself a user of these solutions. From this unique position, Mitsubishi Electric can understand the requirements of other manufacturers only too well. This enables it to sharpen its profile and achieve the optimum balance between cost control and investment.

## What you can expect

- Mitsubishi Electric modular PLC systems meet tomorrow's market requirements today.
- Safe investment thanks to sophisticated and reliable technology.
- The controllers comply with all international quality standards, confirmed by certificates and approvals.
- Standard products, such as control devices and process visualisation software, can be easily combined with all MELSEC controllers.
- Extensive system compatibility.
- European and worldwide availability guaranteed via close-knit sales network.
- Worldwide support and service

# The next level iQ Platform PLC



iQ Platform enables total integration of control and communications

## High performance CPUs

The MELSEC iQ-R series includes a wide range of programmable automation controllers capable of catering to diversified automation control needs, redesigned around the new MELSEC iQ-R high-speed system bus to ensure high performance and intelligent processing power. This enables a single CPU to perform all of the operations that would once have required multiple CPUs, offering dramatic savings in hardware costs. At the same time, mounting of multiple CPUs on an iQ-R series backplane is supported, enabling users to develop vastly more complex and sophisticated automation applications from a single PAC backplane.

## Synchronised control

The MELSEC iQ-R series offers a synchronised PLC and network scan to avoid data transfer delays and improve manufacturing quality. In addition to that all output modules are synchronized for much more precise control.

## Seamless device connectivity

With the MELSEC iQ-R series connected to other devices via CC-Link IE, CC-Link IE Field or Ethernet users can take advantage of Mitsubishi Electric's Seamless Message Protocol (SLMP) to monitor and collect data from devices anywhere on the network without consideration for network layers. For example, there is no longer any need to write code to set up communications – users simply select the communication protocol and the labels to enable the PLC and connected devices to communicate.

## Reduced maintenance effort

The MELSEC iQ-R series incorporates a host of features and functions that help to reduce maintenance efforts and costs. For example, users can define errors and events to be automatically stored to SD card through the in-built SD card slot. In the case of an error or certain event the PLC can store all relevant process information, the error & event log including operation history to an SD card. This data can then easily be analyzed and help to reduce downtime and maintenance effort.

## MELSEC System Q compatibility

The MELSEC iQ-R series is fully compatible with existing MELSEC System Q modules and terminal blocks, providing a simple upgrade path for users. In addition, programs written for the MELSEC System Q can be directly ported to the MELSEC iQ-R series, reducing programming costs for system upgrades.

## Integrated safety control

The MELSEC iQ-R series includes a safety CPU that is compliant with international safety standards, enabling safety devices to be connected via the CC-Link IE Field network.

### MELSEC iQ-R SERIES PLC CPU OVERVIEW

CPU type	Programmable Controller CPU		Safety CPU
Model range	R04CPU-R120CPU	R04ENCPU-R120ENCPU	R08SFCPU-R120SFCPU
Total inputs/outputs	4096	4096	4096
Memory capacity	Program memory	40-1200 k steps	80-1200 k steps
	Data memory	2-40 MB	5-40 MB
Instruction processing time (LD instruction)	0.98 ns	0.98 ns	0.98 ns
Multi CPU capability (max. 4 CPUs)	Yes	No	Yes (one Safety CPU per System)
Built-in CC-Link IE Control/ CC-Link IE Field ports	—	2	—



# The CPUs of the MELSEC System Q

For advanced machine designs and controlling manufacturing cells, including infrastructure and site-wide management, MELSEC System Q's CPUs offer incredible performance and versatility.

Processors are available with a wide range of memory capacities, all of which can be expanded as required. This means that MELSEC System Q PLCs can support complex programs as well as store large volumes of operation data.

## Universal PLC CPUs

Universal PLC CPUs are the latest generation of modular CPUs for the MELSEC System Q controller platform and they are the foundation of the iQ Platform system. They can be combined with the motion, robot and NC CPUs to configure scalable and highly flexible modular automation systems.

## Scalable

All MELSEC System Q PLC processors are interchangeable, which means processing power can be increased as applications grow, protecting your investment in infrastructure and hardware.



Reliable control when you need it most.

## Multi Processor support

Up to four separate MELSEC System Q PLC CPUs can be placed in a single system. These can be used to control their own set of dedicated tasks or for sharing the processing and control load, making the total system highly responsive. This provides users with faster, more dynamic control, leading to better production quality and improved production rates.

## Robots and NC CPUs

Robots and CNC controllers combine faster processing speed and enhanced motion control, providing superior flexibility and performance when designing Motion and Robot automation systems.

### MELSEC SYSTEM Q PLC CPU OVERVIEW

CPU type	Universal PLC	Robot CPU	NC CPU
Model range	Q00UJ–Q02U Q03UD(E)–Q100UD(E)H	Q172DCCPU	Q173NCCPU
Total inputs/outputs	256–4096/8192	32–256	4096/8192
Memory capacity	32 MB	2 MB	*
Program memory	10–1000 k steps	26 k steps	260 k steps
Program cycle period per logical instruction	9.5–120 ns	*	*
Multi CPU capability (max. 4 CPUs)	Yes – up to 4 per system	Yes – up to 3 per system	Yes – up to 2 CPU

\* Please check dedicated manuals

# The compact modular MELSEC L series



Labelling machine controlled by a L series PLC in combination with a Simple Motion module.

## Reliable, ease to use and flexible

The modular MELSEC L series has been designed with high reliability, user friendliness and flexibility in mind and has built-in functions that are usually found only in compact PLCs. Engineers and programmers can use their time more efficiently, saving valuable development time. Thanks to its sophisticated approach, the L series can be used at low costs and with minimum space requirements in a variety of applications. A system that easily fits perfectly in every respect.

## High system flexibility

The rack-free design promotes high system flexibility with minimum form factor. The single-CPU architecture includes built-in Ethernet and Mini-USB interfaces, a SD/SDHC memory card slot for program storage and data logging, and 24 digital I/O for simple high-speed counting and positioning functions.

Besides the functions already built-in, the CPU can be supplemented with up to 40 extension and special func-

tion modules for additional digital and analog I/Os, high-speed counters, communications interfaces, Simple Motion, positioning etc.

## Built-in I/O functions

The L series CPU has all the most important features normally needed already built-in. This minimizes hardware and en-

gineering costs significantly. Up to 2 servo axes or stepper motors can be controlled via the integrated pulse outputs without the need for additional modules.

Every MELSEC L series CPU comes with 24 points of built-in I/Os as standard. These I/O points are capable of many functions usually reserved for separate modules. Save on system costs by using the built-in functions for a variety of applications.

## USB and Ethernet as standard

The built-in USB 2.0 port or Ethernet interface can be used to connect directly at the installation site. The Ethernet interface supports direct connection and does not require any configuration of the PLC or PC to operate.

## Data logging

The built-in data logging function provides an easy way to collect information for troubleshooting, performance evaluation, and other uses. The included configuration tool makes setting up the data logging function a breeze with a step-by-step wizard like interface. Using the software GX LogViewer, the captured data is easy to interpret and understand.

MELSEC L SERIES PLC CPU OVERVIEW		
<b>CPU type</b>	Basic MELSEC L series PLC	
<b>Model range</b>	<b>L02CPU-P</b>	<b>L26CPU-PBT</b>
<b>Total inputs/outputs</b>	1024/8192	4096/8192
<b>Memory capacity for PLC program memory card</b>	20 kB	260 kB
<b>Program memory</b>	Depends on the SD/SDHC memory card used	
<b>Program cycle period per logical instruction</b>	80 k steps	1040 k steps
<b>Multi CPU capability (max. 4 CPUs)</b>	40 ns	9.5 ns
<b>Built-in functions</b>	No	
<b>Integrated I/Os ①</b>	16 inputs (24 V DC)/8 outputs (5–24 V DC, 0.1 A per channel) I/O functions: digital I/Os, high-speed counter inputs, pulse chain output for positioning	
<b>Ethernet connectivity</b>	10BASE-T/100BASE-TX (10/100MBit/s)	
<b>CC-Link connectivity</b>	—	CC-LinkMaster/Local station (up to 10Mbps)

① L02CPU-P/L26CPU-PBT with integrated source outputs

# Safety for all systems

Mitsubishi Electric provides for the MELSEC System Q and the iQ-R series a complete safety solution that can be fully integrated into the automation concept of your system. This allows visualization information, realizing optimal safety control and boosting productivity.

## Flexible implementation

It's obvious that the safety solution has to protect workers from dangerous machinery and environments. However, from a cost perspective, it should also be simple to implement and flexible enough to meet the needs of any system design. MELSEC System Q meets these requirements with a unique, multi-faceted safety solution. The safety functions can either be directly mounted on the rack, be decentralized I/O, or sit on the open CC-Link Safety network.

The MELSEC iQ-R series is equipped with a safety CPU enabling safety devices to be connected via the CC-Link IE Field network.

## Specify with confidence

The safety solutions of the MELSEC System Q and the MELSEC iQ-R series have been fully certified by all applicable safety organizations to EN 954-1 Category 4, ISO 13849-1 PL e, and IEC 61508 (JIS C 0508) SIL 3 and are certified by TÜV Rheinland.

## Integrated generic and safety control

The MELSEC iQ-R series safety CPU can execute both safety and non-safety programs, enabling easy integration into existing or new control systems. The safety CPU enables safety devices such as safety light curtains, emergency switches, and door switches to be connected via the CC-Link IE Field network without requiring a separate dedicated



Keep plant personnel safe from harm

network line. Wiring and space can be reduced as having multiple network cables are no longer required resulting in lower integration costs.

## Easy cost saving

The simplest MELSEC System Q safety option is to fit a safety relay module on the rack alongside all other system components. In this way, a system which is mostly used for conventional control can also meet safety requirements without the need for the cost of a dedicated safety controller. The safety relay modules provide the right number of safety I/O without any special programming.

If safety I/O is required in other locations around the system, safety extension I/O modules offer additional "plug and play" safety by connecting directly to the safety I/O module on the rack.

MELSEC System Q provides also the flexibility to add safety I/O modules to a conventional CC-Link network alongside other CC-Link devices such as inverters, I/O or HMI units.

## Small, simple, and safe

The MELSEC WS Safety Controller provides a cost effective way to add a safety controller capability to individual machines, or smaller scale systems. Its compact size insures easy placement in most control cabinets, without adding extra cost. Configuration saves engineering time by using a graphical icon based method, and program development and certification is simplified by the use of safety function blocks.

## Safeguarding large systems

The MELSEC QS Safety PLC offers a modern approach to safety by combining a CC-Link Safety distributed I/O network with the flexibility of a modular controller. This offers the capacity to cover an entire production line, while bringing the benefits of reduced wiring, rapid diagnostics and easy program modification and maintenance. Of course, since this is a safety controller however, there is a full complement of safeguards against system failure and unauthorized access.

# The challenge of Motion Control



Mitsubishi Electric provides a number of solutions for highly complex, networked motion tasks.

## Extended application range

The current trend for production systems for small quantities with a wide variety of types means that motion controllers are expected to offer a broad usage spectrum. Mitsubishi Electric offers various solutions for motion control, from Simple Motion modules to Motion Controller CPU modules.

Simple motion modules are easy to setup and offer high-precision motion controller performance. This is an easy-to-use module specifically designed for highly precise motion control applications.

## User-friendly development environment

Powerful functions which have been optimised for efficiency are provided via a user-friendly development environment. These simplify system design, commissioning and fault finding, increase data security and lead to shorter downtimes.

## Motion control with the MELSEC System Q

A QDS motion system with Q17nDSCPU controller and QD77MS simple motion module enables various types of control to be implemented such as position, speed and torque control, press and power screwdriver monitoring, synchronous regulation and cam control. Possible applications for these many control types include a wide range of industrial systems such as X-Y tables, winders, packing machines and bottling machines.

The Q17nDSCPU motion controller and the QD77MS Simple Motion module ensure compatibility with conventional servo amplifiers and motion controllers, enabling them to continue to be used.

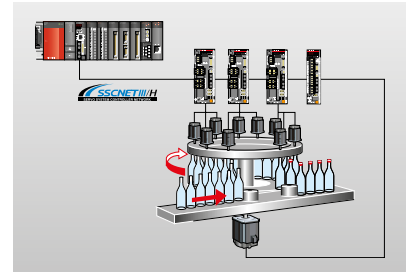

Use of a motion controller for the automatic sealing of bottles



MELSEC System Q brings machine control and motion into harmony.

## Reliable safety monitoring

Safety in production is an absolute must as all machines and equipment must comply with the international safety standards. The Q17nDSCPU is equipped as standard with safety functions which are certified to EN ISO 13849-1 Category 3, PL d.

## Visualising servo data

Information on power consumption is necessary in order to save energy. The Q17nDSCPU and the QD77MS simple motion module have an optional monitoring function which can be used, for example, to read out the motor current or the total power consumption of the servo system via SSCNET III/H. This consumption data can then be analysed on a monitor.

MOTION CONTROLLER CPU AND SIMPLE MOTION MODULE OVERVIEW										
Control method	Network									
	SSCNETIII/H							CC-Link IE Field		
Model	Q172DSCPU	Q173DSCPU	R16MTCPU	R32MTCPU	R64MTCPU	RD77MS	QD77MS	LD77MS	RD77GF	QD77GF
Control axes options	16	32	16	32	64	2-16	2-16	2-16	4-32	4-16
Control units	mm, inch, degree, pulse	mm, inch, degree, pulse	mm, inch, degree, pulse	mm, inch, degree, pulse	mm, inch, degree, pulse	mm, inch, degree, pulse	mm, inch, degree, pulse	mm, inch, degree, pulse	mm, inch, degree, pulse	mm, inch, degree, pulse
Number of positioning data items	600 data items/axes	600 data items/axes	6400	6400	6400	600 data items/axes	600 data items/axes	600 data items/axes	600 data items/axes	600 data items/axes

### Motion control with the MELSEC iQ-R series

The motion CPU is incorporated into the multiple CPU architecture of the MELSEC iQ-R series complementing the programmable controller CPU. Only one Motion CPU module is required to move up to 64 axes synchronously. High-speed communication is realized between the two CPUs via a large bandwidth data buffer memory exchange. High-speed communications are very useful when there is a need to instantaneously transfer a large amount of information such as cam data, thereby simplifying programming even further.

The Simple motion modules of the MELSEC iQ-R series are available with connection to either high-speed servo control network (SSCNETIII/H) or CC-Link IE Field network.

### Positioning with the MELSEC L series

The MELSEC L series also offers a whole range of positioning possibilities. In addition to high-speed counter modules for connection of incremental axes encoders, multi-axis positioning modules for servo or stepper drives with up to 4 axes per module are available.



Servo and motion solutions are increasingly being used across many applications.

4- and 16-axis Motion modules complement the existing positioning modules and round the product portfolio perfectly out. A variety of controls including positioning control, speed control, torque control, cam control and synchronous control can be achieved, which have previously only been possible with „real“ motion control systems. With the Simple Motion modules, complex motion control functions can easily be realized with simple parameter settings and a sequence program.

### Everything from one source

Given this wide range of Simple Motion modules and Motion CPU modules, it is easy to see how the modular PLCs from Mitsubishi Electric can be customized to work with almost any servo manufacturer's products, as well as being totally optimized for use with Mitsubishi Electric's own advanced servo solutions.

### Reduced wiring and less space requirement

With an MR-J4 servo system, the wiring effort and the space requirement



Flexible control options from a single platform.

are drastically reduced. Control via the SSCNETIII bus system is much easier to set up than using a pulse train. With an MR-J4W3-B three-axis amplifier, the space requirement compared with the MR-J3-B is reduced by approx. 30 %.

### Networking: speed and reliability

SSCNETIII/H is a dedicated motion controller network developed by Mitsubishi Electric. It offers many advantages for fast, secure communications between up to 192 servo systems and their host controller.

The latest version is SSCNETIII/H, a powerful third-generation product. It enables high-speed, full duplex, transfer rates of up to 150 Mbit/s as well as guaranteed network system cycle times of 0.22 ms. This extends to all 192 axes, making sure that user applications are really synchronised over all active servo drives.

The use of fibre-optic cabling is a great benefit to all users as it eliminates any concerns about stray electrical noise corrupting the high-speed communication process. This means SSCNETIII/H users enjoy greater reliability and flexibility since the fibre-optic cables can be placed wherever they're needed – even alongside large electrical motors.



# IT for support, monitoring and control



Integrated, embedded or networked – IT is the link from the operational environment to the management function.

Information technology has emerged as the prime conduit linking the operational site to the management function. Not only can production data, schedules and quality information be shared; maintenance and operations can be activated over the same structures.

## Industrial strength IT

MELSEC System Q is unique in being able to embed a fully equipped Windows® PC into a robust industrial design directly at the heart of the control system. The potential uses and benefits are enormous: users are completely free to write their own control and directly actuate I/O control.

Alternatively, the PC CPU can be used as an embedded process monitoring point, running a SCADA installation or user-created Visual Basic applications.

With its fanless design concept, the PC CPU is designed to have as few moving parts as possible, as these are often the points of operational failure. In fact, this principle extends to the optional silicon hard drive, which has no moving parts at all, making Mitsubishi Electric's MELSEC System Q PC CPU ideal for an industrial environment.

This rack-based PC solution can be used as a stand-alone controller or in conjunction with any other MELSEC System Q CPU to create a multidisciplinary automation platform.



Flexible and secure PC technology can even be placed within an application.



C controller add a whole new dimension to flexible control

## As easy as A, B, C

If Mitsubishi Electric's automation platform is divided into A for PLC CPUs, and B for process CPUs, then C must surely stand for the industrial "C" controller.

This advanced controller can be programmed in standard C or C++, opening up the world of automation and control directly to non-PLC based engineers. Furthermore, "C" programming is an ideal language for many process or complex math-based applications since it has a well-defined structured programming concept and flexible syntax.

The MELSEC iQ-R series module R12CCPU-V and the MELSEC System Q module Q12DCCPU-V have been meticulously designed to eliminate as many failure-prone elements as possible, including fans and hard drives. Combined with the widely used VxWorks operating system from Wind River, this makes Mitsubishi Electric C controller a powerful CPU fit for industrial environments. In addition, programming support for the CODESYS controller development system is available from 3S-Smart Software Solutions, which provides users with convenient object-oriented environments.

Based on the Q12DCCPU-V a connection also to Profinet and in combination with a partner solution to Ethernet/IP was realized.

### Remote management

The MELSEC iQ-R series and the MELSEC System Q offer various solutions to the problem of remote management. These can be used independently or combined into multifunction systems.

### Networking

The automation platform supports a variety of networking and communications modules, including Ethernet, CC-Link, CC-Link IE, CC-Link IE Field, CC-Link Safety, MELSECNET/H, FL-NET, Profibus DP, DeviceNet™, AS-interface, Modbus® TCP and Modbus® RTU. Many CPU modules offer build-in networking capabilities, such as Ethernet or CC-Link IE.

Communication is as easy as selecting the module you need.

### Webserver

The QJ71WS96 is a dedicated webserver module that fits directly onto the MELSEC System Q backplane. It offers on-board webpages as well as Java scripting and 100 MB Ethernet that make it easier than ever to share information.

### MES Interface

Both the QJ71MES96 of the MELSEC System Q and the RD81MES96 of the MELSEC iQ-R series offer the possibility to connect directly with commercial database applications like Oracle, MS SQL Server and MS Access. The MES module supports bi-directional data transfer with several databases and the event-driven communications reduce the network load. The use of the MES module reduces system complexity and cost, making gateways a thing of the past.

### IPC panels

Information technology also comes to the MELSEC automation platform in the form of industrial personal Computers (IPCs). These units provide an ideal solution for placing a PC access point directly in the production environment.

Models can be connected directly to the PLC or via a network, ensuring that all areas of the operation are kept supplied with up-to-date information directly from the Automation Controller.



Flexible and reliable communication is a key issue in many application regardless of scale and size.



Web server technology brings intuitive access directly to the heart of the control solution.

OVERVIEW OF PC AND C CONTROLLER CPUs				
<b>CPU type</b>	Windows® PC	C controller	C controller	C controller
<b>Model</b>	<b>Q10WCPU-W1-E/CFE</b>	<b>R12CCPU-V</b>	<b>Q06CCPU</b>	<b>Q12DCCPU</b>
<b>Total inputs/outputs</b>	1 input (shutdown), 2 outputs (shutdown, watchdog timer)	4096	4096/8192	4096/8192
<b>Memory capacity</b>	4 GB, built-in SSD (Solid State Disk)	Use of storage cards means data and programs can be stored for later retrieval		
<b>Program memory</b>	1 GB (main)/ 32+24 kB (L1 cache) / 512 kB (L2 cache)	256 MB/ 4 MB backup RAM	64 MB (main)/ 128 kB battery backed	128 MB (main)/ 128 kB battery backed
<b>Processor speed/ cycle time</b>	Intel® Atom™ Processor N450 1.66 GHz	ARM Cortex-A9 Dual Core	SH RISC Processor *	SH RISC Processor *
<b>Multi CPU capability (max. 4 CPUs)</b>	Yes	Yes	Yes	Yes

\* VxWorks real time system

# MELSEC iQ-R: High-available process control



Mitsubishi Electric offers highly scalable process solutions

## High availability across multiple levels

The MELSEC iQ-R series redundant system enables high availability at multiple levels in the control system hierarchy, from visualization (SCADA) to network control.

## Integrated software simplifies engineering

The integrated engineering software GX Works3 enables programming in multiple program languages such as function block diagram (FBD) for process control. Intuitive features for simplifying process control system engineering include process tag label (variable) sharing, simple program structures, and easy project upload/download to the process CPU.

## Scalable automation solution

The MELSEC iQ-R series enables a process control system through its range of CPU modules (up to 1200 k steps) integrating advanced PID and general control into one module providing excellent system scalability (from small to large) for a best-fit solution. When paired with a redundant function module, it realizes a redundant control system ideal for applications that require highly reliable control. Various network modules with redundant functionality embedded are also available, further improving reliability.

## Embedded PID algorithms

The process CPU includes dedicated algorithms such as two-degree-of-freedom PID, sample PI, and auto tuning support advanced process control.

## Extensive visualization and data acquisition

Through its interconnectivity with supervisory control and data acquisition (SCADA) software, extensive plant-wide monitoring and control can be realized. Mitsubishi SCADA MC Works64 is a next generation supervisory control and data acquisition (SCADA) software providing extensive visualization with its enhanced interconnectivity with the MELSEC iQ-R series. Advanced features such as energy management, scheduling, alarm and event management, trending, reporting, historian, and Geo-SCADA monitoring realize intuitive factory-wide control.

### OVERVIEW OF iQ-R PROCESS CPUs

<b>CPU type</b>	Process CPU
<b>Model range</b>	R08PCPU-R120PCPU
<b>Total inputs/ outputs</b>	4096
<b>Memory capacity</b>	<b>Program memory</b>
	80–1200 k steps
<b>Memory capacity</b>	<b>Data memory</b>
	5–40 MB
<b>Instruction processing time (LD instruction)</b>	0.98 ns
<b>Multi CPU capability (max. 4 CPUs)</b>	Yes (in process mode, not possible in redundant mode)
<b>Build-in CC-Link IE Control/CC-Link IE Field ports</b>	—

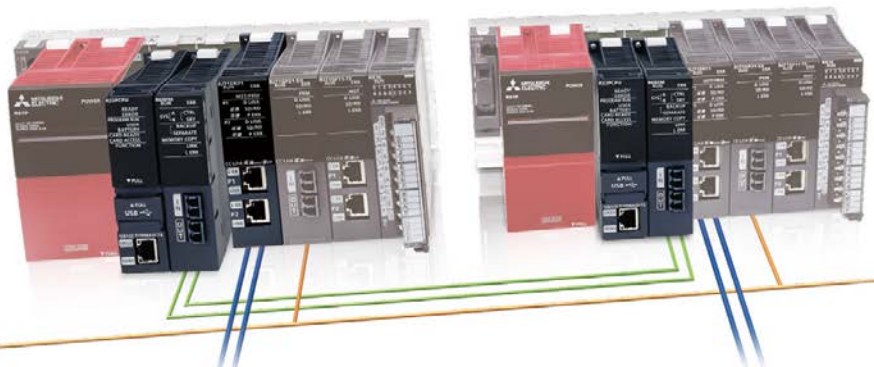



# MELSEC System Q: Process control you can count on



Reliable system operation is essential in the process industry.

## A platform to build on

The strength of MELSEC System Q's automation platform really comes into its own in traditional specialist industries. The unique flexibility of proven off-the-shelf control components such as I/O and communication devices, teamed with dedicated special devices like process CPUs, assures high functionality, ease of use and targeted control – all within budget.

## Two worlds meet

Our dedicated MELSEC System Q process CPUs build on the already high functionality of Mitsubishi's advanced PLC CPUs. This powerful combination of sequential control overlaid with dedicated process instructions gives users a hybrid control solution with the best of both worlds.

This is complemented in turn by a range of dedicated channel-isolated and high-resolution analogue modules. Here, too, a combination of specialized and standard modules as well as HART protocol supporting analog I/O's provide the basis for practical and flexible solutions.

High system availability can be maintained through various means, including redundant process CPUs, stand-by network masters, and redundant network configurations, as well as by wire-break detection and a "hot-swap" capability that allows modules to be replaced during live operation.

Programming can be implemented using a wide range of tools such as IEC 61131-3 compliant software and the process-dedicated PX Developer.

## Process control MELSEC System Q



The high availability of the dual redundant MELSEC System Q can be applied to a wide range of industries from Food and Utilities to Process, and Chemical.

### High reliability systems

The MELSEC System Q automation platform can also be applied to other areas requiring high reliability, e.g. standby network masters, redundant fieldbus (CC-Link) and redundant power supplies for remote I/O stations.

In addition, selected analogue and temperature control units have a wire-break detection feature enabling them to determine the difference between an actual signal and one that has been lost due to external system damage.

### Process CPUs

MELSEC System Q's Process CPUs bring the benefits of standard MELSEC System Q technology into the process environment, reducing both implementation and long-term running costs. These powerful processors combine standard PLC control with 52 dedicated process control functions, including loop controls with two degrees of freedom (DOF) and high-speed PID control.

### Redundant CPUs

Mitsubishi Electric's dual-redundant CPUs bring an additional layer of fault tolerance to the control of a whole system. This results in high reliability: if the main CPU, power supply or base unit fails, a secondary system starts immediately (within 21 ms) from the same control point.

For users this has two major benefits: no operational damage due to a single system failure, and production that continues seamlessly.



Complex processes involving liquids, pressures, temperatures can often need fast PID control algorithms.

OVERVIEW OF SYSTEM Q PROCESS CPUs						
CPU type	Process CPU				Redundant CPU	
Model	Q02PHCPU	Q06PHCPU	Q12PHCPU	Q25PHCPU	Q12PRHCPU	Q25PRHCPU
Total inputs/outputs	4096/8192					
Memory capacity	32 MB					
Program memory	28 k steps	60 k steps	124 k steps	252 k steps	124 k steps	252 k steps
Program cycle period per logical instruction	34 ns					
Multi CPU capability (max. 4 CPUs)	Yes – up to 4 per system				No	

# Programming and visualisation



Mitsubishi Electric's MELSOFT suit of software tools brings productivity and ease of use.



GOT2000 displays offer high resolution and touch screen technology.

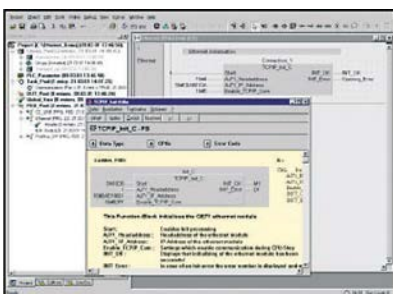

Advanced software packed in an easy to use interface.

One of the largest cost components of any project is not the control hardware but the time required to create and write the application. Mitsubishi Electric's MELSOFT software solutions help you save time by making it easier to reuse existing work, as well as making interfaces simpler and more intuitive. In addition, MELSOFT provides innovative tools to help users increase their productivity in planning, implementation, service and support.

### Programming

Three software packages are available: one in standard Mitsubishi Electric format, another in compliance with IEC 61131-3, and a third one for process control applications. This enables customers to choose the best solution for their needs. Mitsubishi Electric's programming solutions help you save time by making it easier to reuse existing programming code; they also have simple, intuitive interfaces.

### Communication

MELSOFT communication packages are designed to integrate Mitsubishi Electric products with other software packages by using plug-ins or drivers. The user benefits from the reliability and quality of Mitsubishi Electric hardware combined with the familiarity of software tools such as Microsoft Excel, Active X and OPC.

### Visualization

Mitsubishi Electric supplies both SCADA- and PC-based HMI solutions for data analysis, maintenance and linking into other high-end business operations packages.

### Human Machine Interfaces

In addition to software visualization solutions, Mitsubishi Electric offers one of the world's widest ranges of HMI, GOT and IPC technologies. Solutions range from simple small text screens all the way through to high-resolution touch screens and full-fledged industrial PCs, complimenting the range and power of the modular PLC platforms.

PACKAGE	GX WORKS2/ GX WORKS3	PX DEVELOPER	IQ WORKS
<b>IEC 61131-3 compliance</b>	Yes	No	Yes
<b>Languages</b>	LD/IL/FBD/ST/SFC	LD/IL/SFC	LD/IL/FBD/ST/SFC
<b>Simulator</b>	Yes	No	Yes
<b>Special function block setup utilities</b>	Yes	Yes	Yes

LD = Ladder Diagram, IL = Instruction List, FBD = Function Block Diagram, ST = Structured Text, SFC = Sequential Function Chart

# Plant solutions



e-Factory turns the idea into a reality.

Companies often mull over and discuss factory or plant-wide management solutions for many years – but without ever actually implanting them. After all, they are understandably reluctant to halt production for an extended period while the new system is being fitted, and find the prospect of organizing and planning the whole activity daunting, especially since they often want to implement a new solution all at once.

## e-Factory

Mitsubishi Electric's e-Factory solution answers a lot of these issues. It is based on the MELSEC System Q and MELSEC iQ-R series automation platform concept. Thanks to the modular design of these automation controllers, it is now much easier to implement plant-wide control based on segmented or manufacturing cell solutions.

## Communication

Plant-wide operations rely on good communication strategies. The MELSEC automation platform can support over 50 different forms of communication, including standard RS232, fieldbuses, Ethernet, webservers and redundant networks.

## Making life easy

Traditionally, the interface between MES and the production environment has been separated by a layer of management PCs and master PLCs used for concentrating data and cell information. With the MELSEC automation platform, this structure can be simplified by embedding the PC directly on the same backplane. This removes a layer of management structure as well as simplifies implementation.

Each customer's requirements are different and the modular PLCs from Mitsubishi Electric are designed to offer a wide range of solutions that can be easily adapted. For example, MELSEC System Q enables the use of local embedded webserver technology, meaning that Ethernet and web-based browsing can be used for capturing data. Moreover, a dedicated MES interface allows MELSEC System Q and the iQ-R series to "talk" directly to the MES software without any intermediary devices, reducing implementation and on-going maintenance costs.

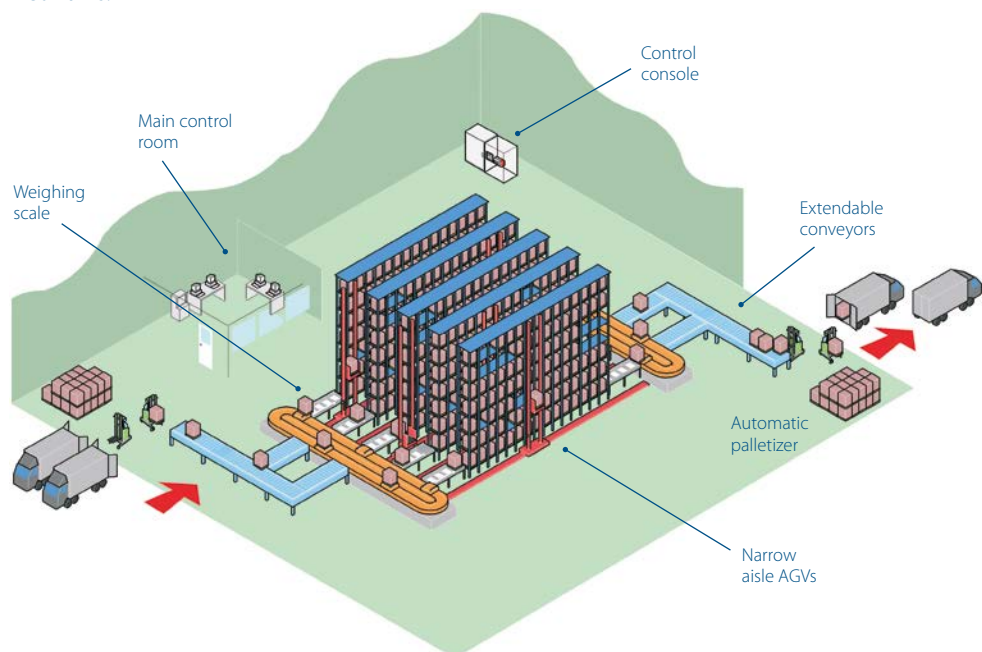

Optimal operation occurs when all elements within a plant are kept constantly running, this can only be achieved with reliable co-ordination and integration.

# Machine solutions

Each machine presents different challenges to the control system. Sometimes high quantities of I/O are required locally or are networked. Small controller size is often important, while at other times the key factors will be temperature, positioning, or analogue control.

For the machine designer, an ideal solution is to have a standard control philosophy that can be adapted to each machine's individual needs. This is exactly what the modular PLCs of Mitsubishi Electric bring to machine control.

## Compact

Due to its modular design, the modular PLCs from Mitsubishi Electric use less panel space than many other controllers. In addition, Mitsubishi Electric offers a wide range of high-density I/O cards and analogue modules that are ideal for minimizing installation space. For very compact installations, the rack-free PLC of the MELSEC L series is the ideal choice, which can additionally be enhanced by network modules or remote I/Os.

## Flexible

When designing a control system for a given machine, flexibility is often a key requirement. Many machine manufacturers develop ranges of products which require a basic control concept to which additional features can be added as machine performance increases. Considering that, the modular PLCs of Mitsubishi Electric are ideal.

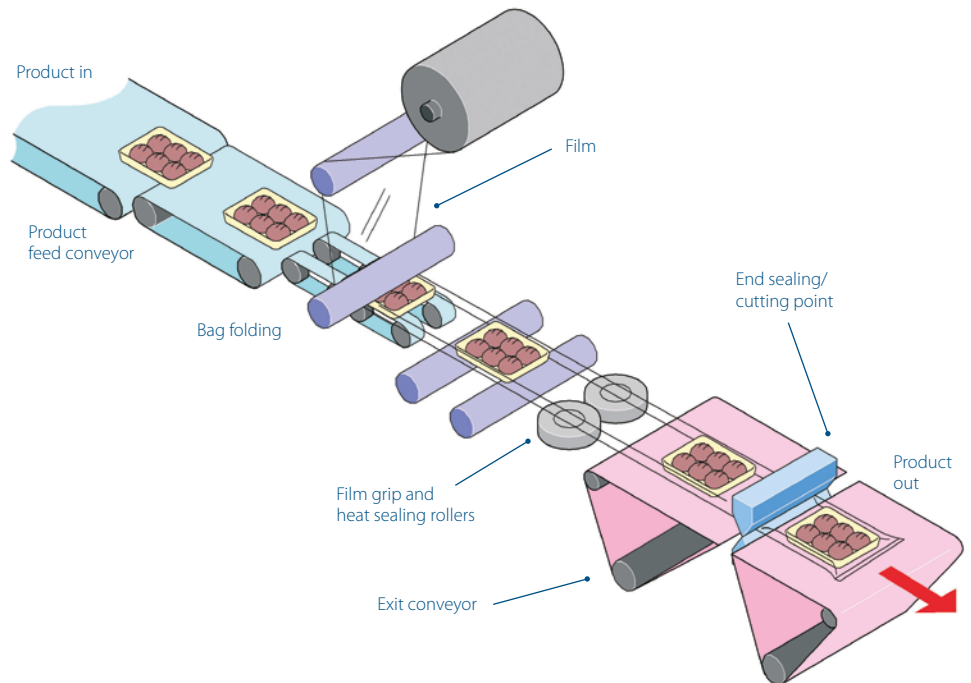

A horizontal packaging machine can present many challenges to the automation engineer.



Example of temperature control.

## Easy programming

One of the largest costs in any control solution is the programming and engineering time. The modular PLCs from Mitsubishi Electric overcome this problem with user-friendly, intuitive programming tools. With all that, reusable program components and the use of function blocks and the sequential function chart were placed in the foreground. Embedded set-up tools support this process, making the configuration of special function modules simple, quick, and easy.

The modular PLCs from Mitsubishi Electric encompass a wide range of modules, including various types of temperature and analogue modules, different positioning modules and a wide range of communication devices. These modules can be combined with all CPUs.

# A world of applications



Plant control solutions



Remote management solutions include SCADA, networking, telemetry and industrial modems.

Mitsubishi Electric products are found in an almost infinite variety of industrial, infrastructure and service sector contexts, ranging from critical applications in the pharmaceuticals industry to state-of-the-art leisure and entertainment facilities. Here are just a few examples of recent applications:

- Agriculture
  - Irrigation systems
  - Plant handling systems
  - Sawmills
- Building management
  - Smoke detection monitoring
  - Ventilation and temperature control
  - Lift (elevator) control
  - Automated revolving doors
  - Telephone management
  - Energy management
  - Swimming pool management

- Construction
  - Steel bridge manufacturing
  - Tunnel boring systems
- Food and drink
  - Bread manufacture (mixing/baking)
  - Food processing (washing/sorting/slicing/packaging)
- Leisure
  - Multiplex cinema projection
  - Animated mechatronics (museums/theme parks)
- Medical
  - Respiration machine testing
  - Sterilization
- Pharmaceutical/chemical
  - Dosing control
  - Pollution measurement systems
  - Cryogenic freezing
  - Gas chromatography
  - Packaging
- Plastics
  - Plastic welding systems
  - Energy management systems for injection moulding machines
  - Loading/unloading machines
  - Blow moulding test machines
  - Injection moulding machines
- Automotive
- Printing
- Textiles
- Transportation
  - Sanitation on passenger ships
  - Sanitation on rail rolling stock
  - Fire tender, pump management
  - Waste disposal truck management
- Utilities
  - Waste water treatment
  - Fresh water pumping
  - Sewage plants

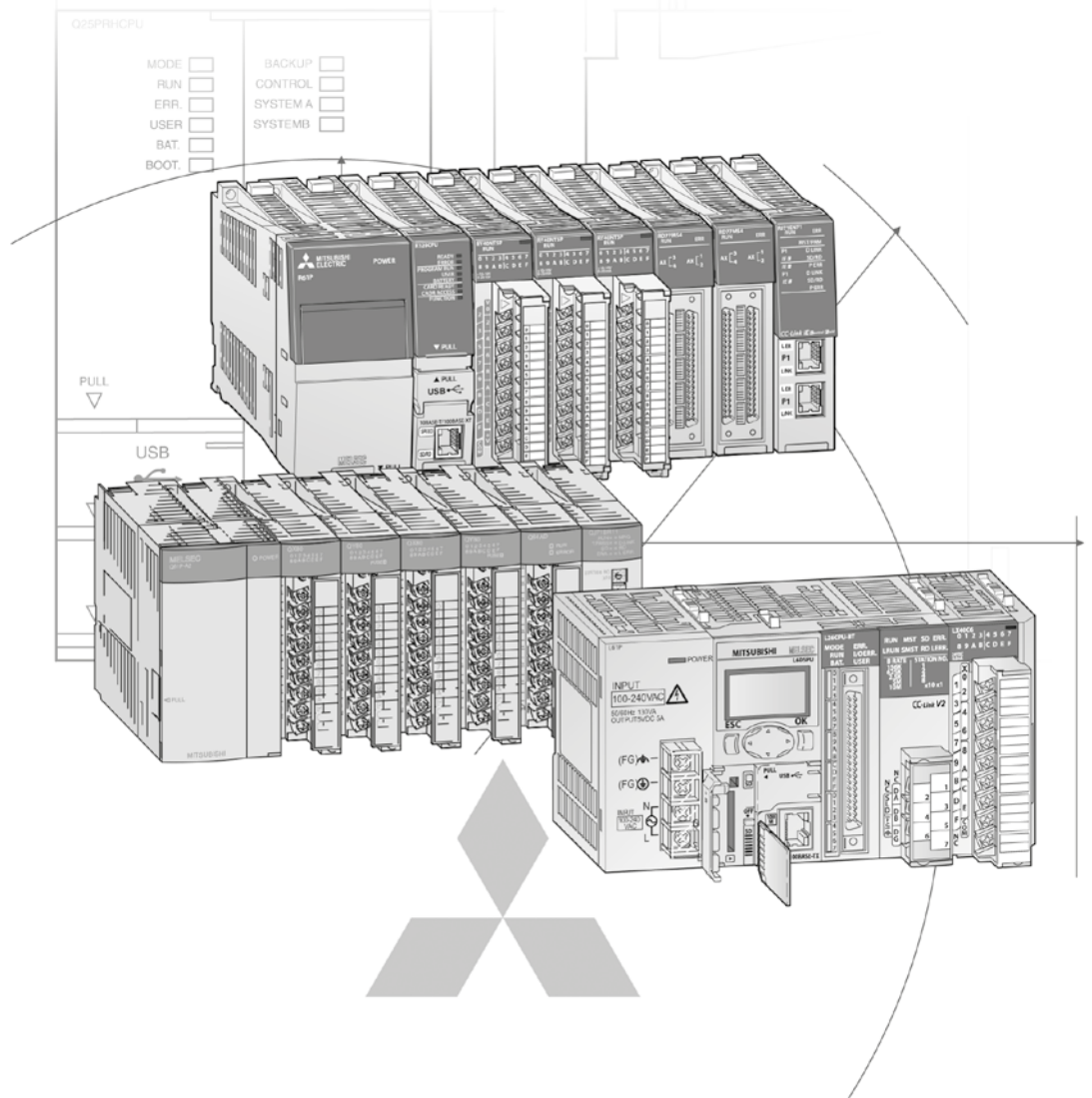

# Technical Catalogue

## Further publications within the industrial automation range

### Brochures

#### **FX Family**

Product catalogue for programmable logic controllers and accessories for the MELSEC FX family

#### **HMI Family**

Product catalogue for operator terminals, supervision software and accessories

#### **FR Family**

Product catalogue for frequency inverters and accessories

#### **MR Family**

Product catalogue for servo amplifiers and servo motors as well as motion controller and accessories

#### **MELFA Family**

Product catalogue for industrial robots and accessories

#### **LVS Family**

Product catalogue for low voltage switchgears, magnetic contactors and circuit breakers

#### **Automation Book**

Overview on all Mitsubishi Electric automation products, like frequency inverters, servo/motion, robots etc.

---

### **More information?**

The catalogue at hand is designed to give an overview of the extensive range of iQ-R, System Q and L series of MELSEC PLCs. If you cannot find the information you require in this catalogue, there are a number of ways you can get further details on configuration and technical issues, pricing and availability. For technical issues visit the <https://eu3a.mitsubishielectric.com> website. Our website provides a simple and fast way of accessing further technical data and up to the minute details on our products and services. Manuals and catalogues are available in several different languages and can be downloaded for free.

For technical, configuration, pricing and availability issues contact our distributors and partners. Mitsubishi Electric partners and distributors are only too happy to help answer your technical questions or help with configuration building. For a list of Mitsubishi Electric partners please see the back of this catalogue or alternatively take a look at the "contact us" section of our website.

### **About this technical catalogue**

This catalogue is a guide to the range of products available. For detailed configuration rules, system building, installation and configuration the associated product manuals must be read. You must satisfy yourself that any system you design with the products in this catalogue is fit for purpose, meets your requires and conforms to the product configuration rules as defined in the product manuals.

Specifications are subject to change without notice. All trademarks acknowledged.

© Mitsubishi Electric Europe B.V., Factory Automation - European Business Group

**The products of Mitsubishi Electric Europe B.V., that are listed and described in this document, are neither subject to approval for export nor subject to the Dual-Use List.**



# MELSEC modular PLCs – iQ-R series, System Q and L series

## 1 Modular overview

### MELSEC iQ-R SERIES, SYSTEM Q AND L SERIES

◆ Specifications .....	6
◆ Overview of the modular series .....	7
◆ Special functions MELSEC iQ-R .....	10
◆ Special functions MELSEC System Q .....	12
◆ Special functions MELSEC L .....	14

## 2 MELSEC iQ-R series

### SYSTEM DESCRIPTION AND BASIC COMPONENTS

◆ Configuration and handling .....	16
◆ Base units .....	17
◆ Power supply modules .....	18
◆ CPU modules .....	19

### DIGITAL MODULES

◆ Input modules .....	24
◆ Output modules .....	26
◆ Combined I/O module .....	28

### SPECIAL FUNCTION MODULES

◆ Analog modules .....	29
◆ Temperature control modules .....	32
◆ High-speed counter modules .....	33
◆ Positioning modules .....	34
◆ Simple Motion modules .....	35
◆ Interface modules .....	36
◆ Network modules .....	37
◆ MES Interface module .....	38
◆ iQ-R C-Application Server .....	39
◆ High-speed data logger module .....	40
◆ C intelligent function module .....	41

### DIMENSIONS

◆ Dimensions .....	42
--------------------	----

### ACCESSORIES

Refer to chapter 5

### 3 MELSEC System Q

#### SYSTEM DESCRIPTION AND BASIC COMPONENTS

- ◆ Configuration and handling .....45
- ◆ Base units .....50
- ◆ Power supply modules .....52
- ◆ CPU modules .....53

#### DIGITAL MODULES

- ◆ Input modules .....60
- ◆ Output modules .....62

#### SPECIAL FUNCTION MODULES

- ◆ Analog modules .....64
- ◆ Temperature control modules .....69
- ◆ Load cell module .....70
- ◆ Analog CT input module .....71
- ◆ Loop control module .....72
- ◆ Counter modules .....73
- ◆ Positioning modules .....75
- ◆ Simple Motion modules .....79
- ◆ Interface modules .....80
- ◆ Network modules .....82
- ◆ Web server module .....83
- ◆ MES Interface module .....84
- ◆ Q Series C-Application Server .....85
- ◆ High-speed data logger module .....86
- ◆ Interrupt module and high-speed inputs .....87

#### DIMENSIONS

- ◆ Dimensions .....88

#### ACCESSORIES

Refer to chapter 5

### 4 MELSEC L series

#### SYSTEM DESCRIPTION AND BASIC COMPONENTS

- ◆ Configuration and handling .....92
- ◆ Power supply modules .....94
- ◆ CPU modules .....95

#### DIGITAL MODULES

- ◆ Input modules .....96
- ◆ Output modules .....97

#### SPECIAL FUNCTION MODULES

- ◆ IO-Link module .....98
- ◆ Analog modules .....99
- ◆ Temperature control modules .....104
- ◆ Flexible high-speed I/O control module .....105
- ◆ Counter modules .....106
- ◆ Interface modules .....107
- ◆ Positioning modules .....108
- ◆ Simple motion modules .....109
- ◆ Network modules .....110
- ◆ Serial communication adapter and end cover .....111

#### DIMENSIONS

- ◆ Dimensions .....112

#### ACCESSORIES

Refer to chapter 5

## 5 Accessories

### ACCESSORIES FOR THE MELSEC MODULAR SERIES

- ◆ Batteries, DIN rail mounting adapters, connection cables with connectors. ....114
- ◆ 37 and 40-pin connectors, wireless LAN adapter. ....115
- ◆ Industrial switching HUB, Ethernet adapter module .....116

### MELSEC iQ-R series

- ◆ SD memory cards, extended SRAM cassettes, connection cables, blank cover modules .....117

### MELSEC System Q

- ◆ Dummy module, ERNT – conversion adapters, PCMCIA adapter unit .....118
- ◆ Connection cables, tracking cables, programming cables. ....119
- ◆ Connector disconnection prevention holder, adapter cables, memory cards .....120
- ◆ Extended SRAM cassettes, SRAM card batteries, interchangeable terminal blocks for I/O modules. ....121

### MELSEC L series

- ◆ Display module, SD memory cards, branch/extension module .....122
- ◆ Space module, extension cables, spring clamp terminal block (push-in type) .....123

## 6 Programming systems

### PROGRAMMING

- ◆ Software, iQ Works .....124
- ◆ GX Works, visualisation software .....125
- ◆ Profibus software .....126

## Appendix

- ◆ Index .....128

1  
2  
3  
4  
5  
6

# Modular PLCs – MELSEC iQ-R series, System Q and L series

1  
Modular overview

## MELSEC iQ-R

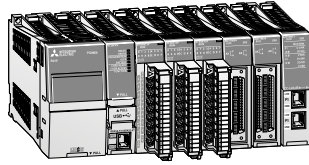

## MELSEC System Q

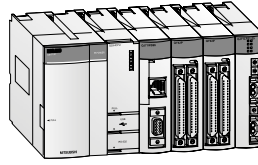

## MELSEC L

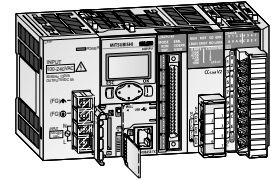

Specifications	Modular type	Modular type	Baseless type		
Lineup	<b>Programmable controller CPU: 5 models</b> <b>CC-Link IE embedded CPU: 5 models</b> <b>Safety CPU: 4 models</b> <b>Process CPU ①: 4 models</b> <b>C Controller: 1 model</b> <b>Motion CPU: 3 models</b>	<b>Programmable controller CPU (Universal model): 25 models</b> <b>Process CPU: 4 models</b> <b>Redundant CPU: 2 models</b> <b>C Controller: 4 models</b> <b>Motion CPU: 2 models</b> <b>Robot controller: 1 model</b> <b>NC CPU: 1 model</b>	<b>Programmable controller CPU</b> <b>Sink type: 5 models</b> <b>Source type: 5 models</b>		
Control method	Stored program cyclic operation	Stored program cyclic operation	Stored program cyclic operation		
I/O control mode	Refresh mode	Refresh mode	Refresh mode		
Programming language	Ladder diagram Structured text (ST) Sequential function chart (SFC) ② Function block diagram (FBD/LD) Function block (FB) C/C++ ③	Ladder diagram Structured text (ST) Instruction list MELSAP3 (SFC), MELSAP-L Function block diagram (FBD) Function block (FB) C/C++ ③	Ladder diagram Structured text (ST) Instruction list MELSAP3 (SFC), MELSAP-L Function block (FB)		
Engineering environment	MELSOFT GX Works3 MELSOFT MT Works2 CW Workbench	MELSOFT GX Works2 MELSOFT PX Developer MELSOFT MT Works2 CW Workbench	MELSOFT GX Works2		
Program size	K step	1200	1000		
Number of I/O points [X/Y]	point	4096	4096		
Device/label memory/standard RAM	K byte	3380	1792		
Data memory/standard ROM	byte	40M	16M		
Processing speed	LD instruction	ns	0.98	1.9	9.5
	MOV instruction	ns	1.96	3.9	19
	Floating point addition	μs	0.01	0.014	0.057

① Supports redundant system when paired with redundant function module R6RFM  
 ② SFC is not supported in redundant mode and by safety CPU  
 ③ When using CW Workbench

## MELSEC iQ-R series

The iQ Platform builds on the power of Mitsubishi Electric's high performance programmable automation controllers (PAC), complementing this with a broad range of control modules and network interfaces.

The iQ-R series CPU offers dramatic improvements in performance, setting new benchmark standards for processing speed. At the same time, the iQ-R series offers reductions in development cost, maintenance cost and risk of system failure, while providing an innovative upgrade path that will enable users to take advantage of ongoing developments through software upgrades rather than hardware upgrades.

Mounting of multiple CPUs on an iQ-R series backplane is supported, enabling users to develop vastly more complex and sophisticated automation applications from a single PAC backplane.

- Productivity – Improve productivity through advanced performance/functionality
- Scalability – offers Multi CPU solutions on a single backplane
- Connectivity – Seamless connectivity within all levels of manufacturing
- Flexibility – solutions can combine 4 CPU types as a seamless solution; PLC, Motion, Robots, NC, PC and Process CPUs

- Engineering – Reducing development costs through intuitive engineering
- Compatibility – Compatible with most existing MELSEC System Q I/O
- Security – Unauthorized access protection across distributed control network
- Maintenance – Reduce maintenance costs and downtime utilizing easier maintenance features

## MELSEC System Q

MELSEC System Q has been designed to be at the heart of your manufacturing process, as it is at the heart of Mitsubishi Electric's component automation concept. It offers you total integration of your control and communication needs from a single platform – connecting your automation with your business needs.

- Communication – is a communication hub connecting to fieldbus or data networks including 100 Mbps Ethernet
- Scalability – offers Multi CPU solutions on a single backplane
- Flexibility – solutions can combine 4 CPU types as a seamless solution; PLC, Motion, Robots, NC, PC and Process CPUs

- MES and web server module for quick and simple connectivity to the IT world
- Redundancy options ranging from full redundant PLC hardware to redundant network options improve uptime and productivity

## MELSEC L series

The MELSEC L series is a powerful but compact modular controller with many features built-in to the CPU itself. The rack-free design promotes high system flexibility with minimum form factor. Built-in Mini-B USB and Ethernet allow for easy communication, along with a built-in SD/SDHC memory slot for data logging and memory storage, and built-in digital I/O for simple high-speed counting and positioning functions.

The high-performance version CPU also includes a built-in CC-Link interface for Master/Local Station networking. This highly flexible architecture makes the MELSEC L series ideal for both stand-alone and networked machines.

- Rack-free design
- CPUs packed with comprehensive built-in features/functions
- Integrated data logging

- Built-in I/O features
- Communication and networking capabilities
- High-end 16-axis motion expansion possible using SSCNETIII/H

## Equipment features

Modular controllers like Mitsubishi Electric's MELSEC iQ-R series, System Q and the L series are high-performance PLC systems with broad functionality. The range, power and function of these high-end PLCs is impressive, with operation times measured in nanoseconds.

The modular design allows flexible usage in a broad range of applications. Additional back-planes can be added as the system expands.

Modular PLCs comprise a power supply, one or more CPU modules and I/O and/or special function modules.

### Use of digital and special function modules

The use of digital and analog modules and most special function modules is dependent only on the maximum available number of addresses and thus on the CPU used in each case.

The following modules are available for assembling the system:

#### Pulse catch and interrupt modules

Digital input modules for pulse storage and for processing subroutines.

#### Communications modules

Interface modules with RS232/RS422/RS485 interface for connection of peripherals or for PLC-PLC communication.

#### Network modules

For interfacing with Ethernet, CC-Link, CC-Link IE, Profibus DP/Profinet, Modbus®/TCP/RTU, DeviceNet™, AS-Interface and MELSEC networks.

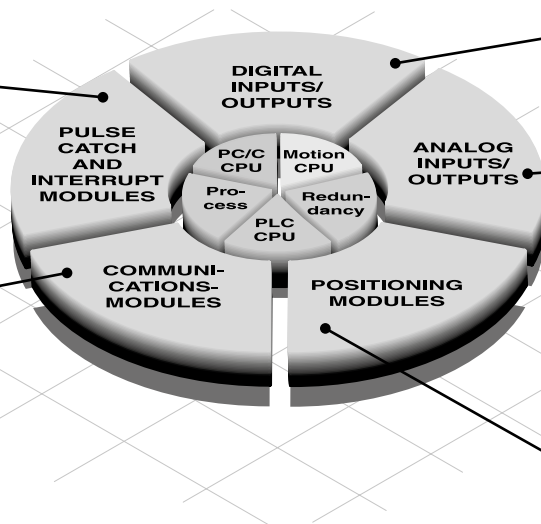

#### Digital input/output modules

For various signal levels with transistor, relay or triac switches.

#### Analog input/output modules

For processing current/voltage signals and for temperature value acquisition as well as temperature control with direct connection of Pt100 resistance thermometers or thermocouples. A HART enabled module for current input is also available for the MELSEC System Q.

#### Positioning modules

High-speed counter modules with possibility for connection of incremental shaft encoder or multi-axial positioning modules for servo and step drives with up to 8 axes per module.

## The MELSEC PLC family

### Modular PLCs

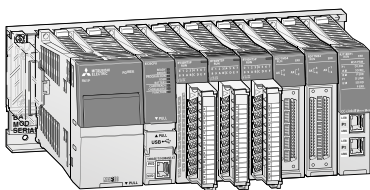

MELSEC iQ-R series

MELSEC System Q

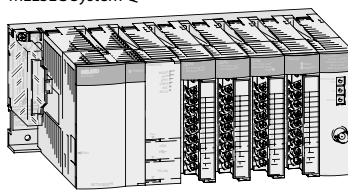

MELSEC L series

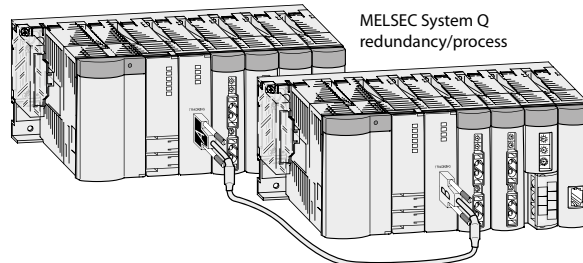
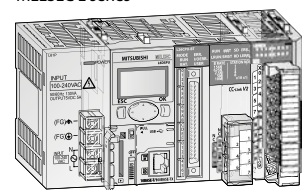

MELSEC System Q redundancy/process

### Compact PLCs

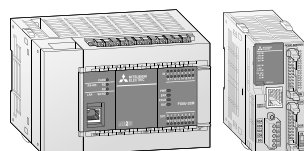

MELSEC iQ-F  
FX5 series

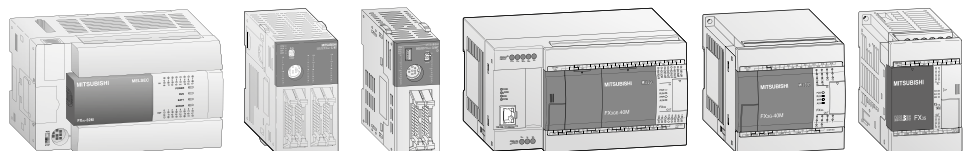

MELSEC FX3 series

## iQ Platform

Mitsubishi Electric provides all aspects of control on a consolidated automation platform. With the iQ Platform, which includes the MELSEC iQ-R series and System Q, we provide an extensive array of controller types. This platform not only has sequence controllers, but also

other various controllers specific to an industry or application area. These are, process controller, C language, embedded industrial PC, CNC controller, robot controller and HMI. Together with the abundant I/O that is available for this series, the iQ Platform solution can be

applied to almost any kind of application scope, with productivity kept optimum and reduced TCO being key.

This is a true solution for automation, this is iQ Platform.

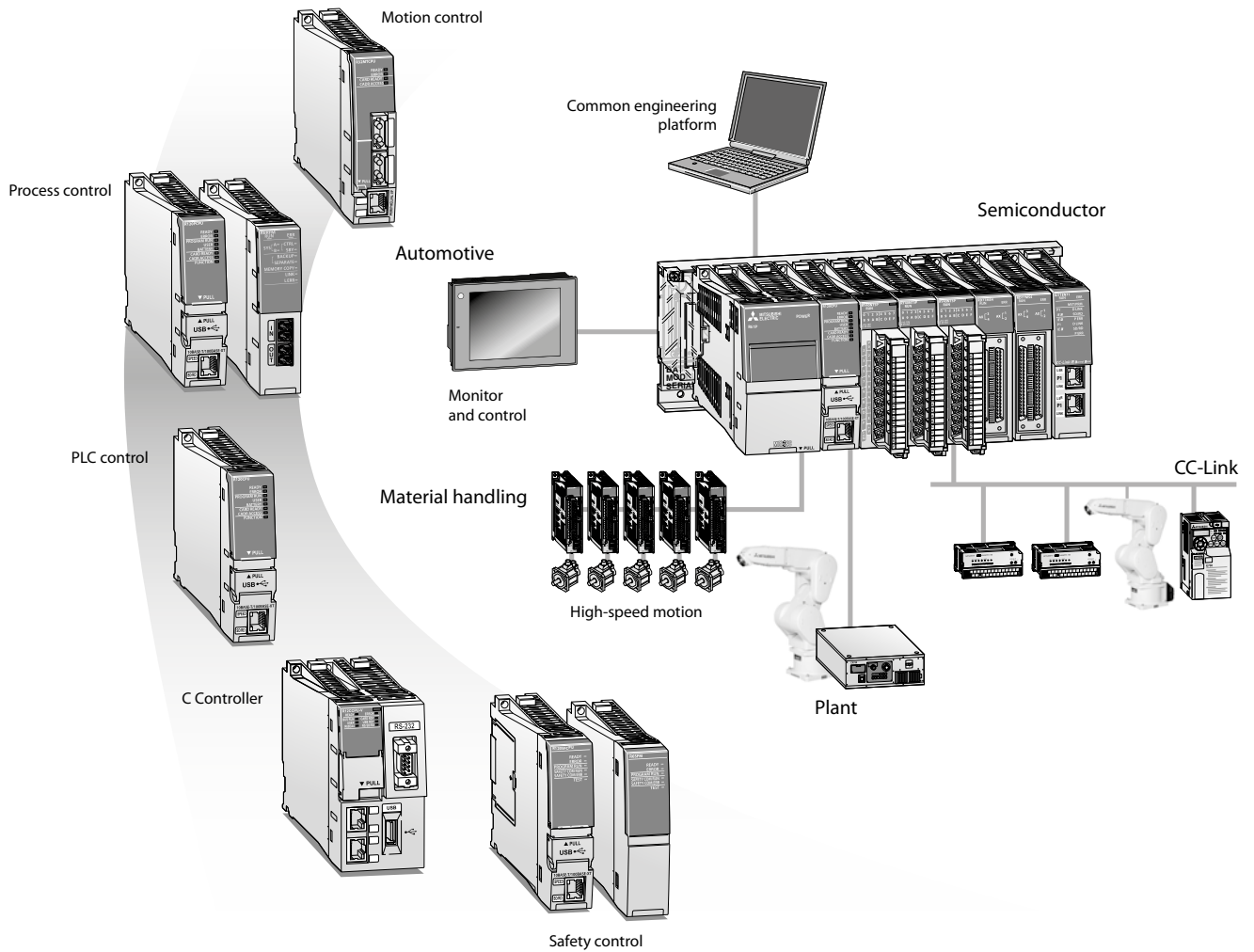

## MELSEC iQ-R – advanced built-in functions

1 Modular overview

### ■ Safety

iQ-R series    System Q    L series

#### System design flexibility with integrated safety control

Ensuring the safety of personnel on the factory floor is a fundamental requirement of manufacturing plants and requires stringent safety regulations. To adhere to this safety code for control systems, the MELSEC iQ-R series is equipped with a safety CPU that is compliant with international safety standards, enabling safety devices to be connected via the CC-Link IE Field network. The entire system can be programmed using GX Works3 programming software as standard.

- Integrated generic and safety control
- Consolidated network topology
- Compliant with international safety standards

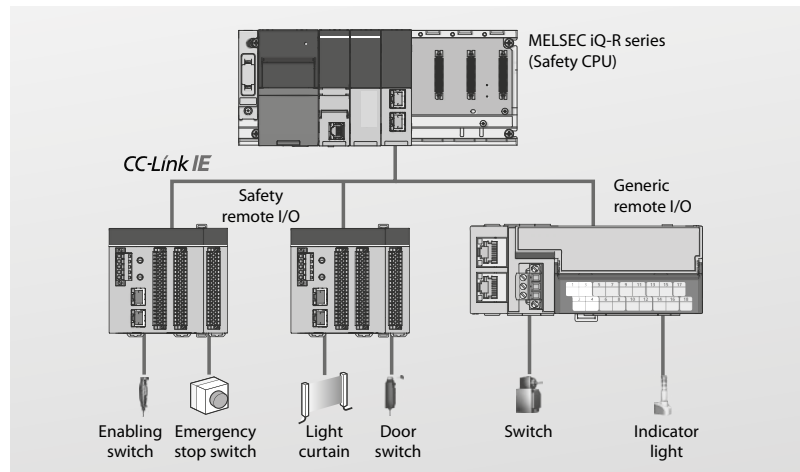

Integrated safety control offering a total system solution

### ■ Productivity

iQ-R series    System Q    L series

#### High-available process control in a scalable automation solution

Integrating high-performance capabilities based on the high-end iQ-R system bus, high-speed network, and an advanced motion control system; applications requiring these characteristics can be easily realized using the MELSEC iQ-R series as the core of the automation system.

CC-Link IE Field provides deterministic performance over Industrial Ethernet ensuring synchronization between nodes.

- High-speed system bus realizes improved production cycle
- Super-high-accuracy motion control utilizing advanced multiple CPU features
- Inter-modular synchronization resulting in increased processing accuracy

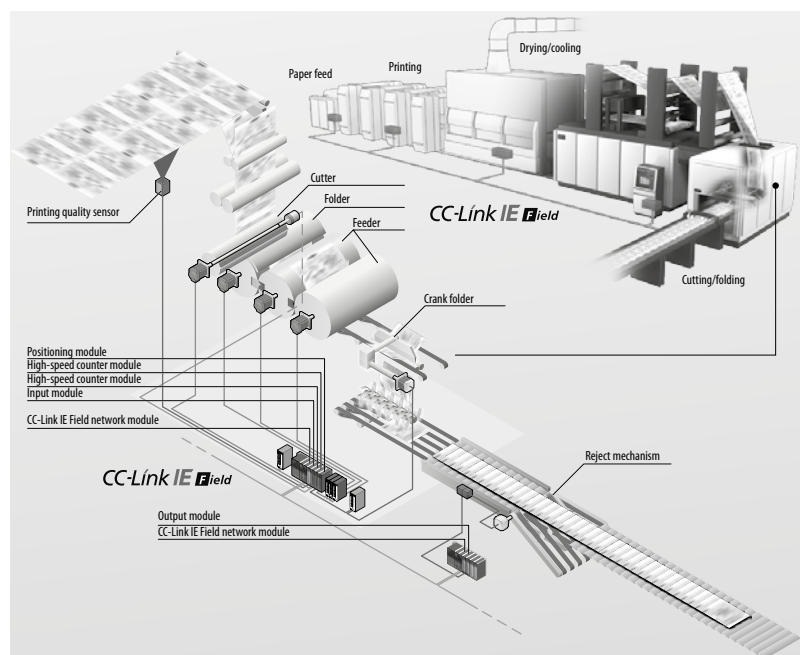

Example of cutting and folding application



## Intelligence

### Extensive data handling from shop floor to business process systems

With ever-changing manufacturing trends, production data management, analysis, and planning are more mainstream helping to realize leaner operations, improve yield, and create a more efficient supply chain. The MELSEC iQ-R series includes the MES Interface, C Controller and C Intelligent function, and high-speed data logger modules as part of the "Intelligence" lineup of interconnected advanced information products.

- Direct data collection and analysis
- C/C++ based programming
- Collect factory data in real-time
- Expand features using third party partner applications

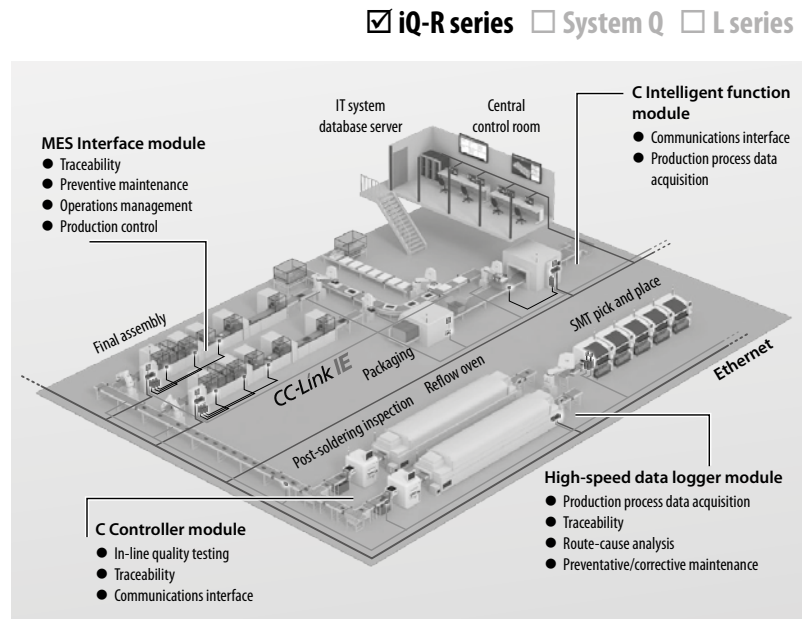

Extensive data handling from shop floor to business process systems

## Security

### Robust security that can be relied on

As technology becomes more complex and the distribution of manufacturing systems more global, the protection of intellectual property is even more significant. When shipping a finished product overseas, the last thing an OEM needs to consider is unauthorized copying or changing of the original project data. In addition to this, unauthorized access to the control system can have very serious implications to the control system and the end user, which can compromise the overall safety of the plant.

- Protect intellectual property
- Unauthorized access protection across distributed control network

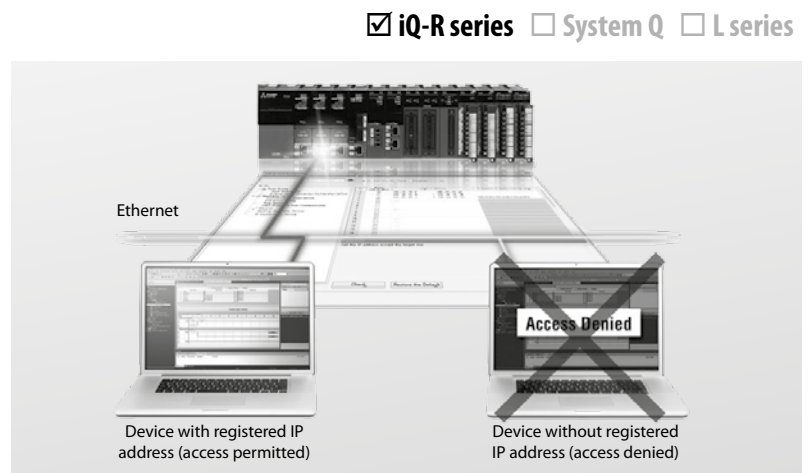

Prevent unauthorized access across the network

## Process

### High availability process control in a scalable automation solution

MELSEC iQ-R series process CPU modules are designed to cover wide-ranging process control applications, from small to large-scale. All models provide high-speed performance coupled with the ability to handle large PID loops utilizing embedded PID control algorithms; integrating both general and process control into one module. When paired with a redundant function module, a redundant control system ideal for applications that require highly reliable control can be easily realized at a low cost.

- Extensive visualization and data acquisition
- High availability across multiple levels
- Integrated process control software simplifies engineering

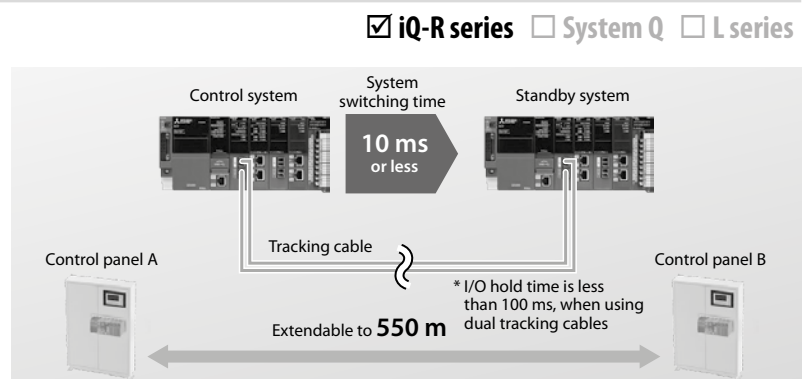

Example of redundant system remote location and high-speed switching

# MELSEC System Q – advanced built-in functions

1 Modular overview

## Multiple solutions for a vast range of applications

The MELSEC System Q series lineup covers a various range of applications be it, programmable controller, process, motion, or information control.

The basic model QCPU range is designed ideally for small scale applications. With the unique Multiple CPU functionality, each process area of the application can be selectively controlled by different CPUs situated on the same main base unit. Therefore, this lineup provides an ideal solution for each required application.

The redundant CPU system ensures robust operation in the event of trouble.

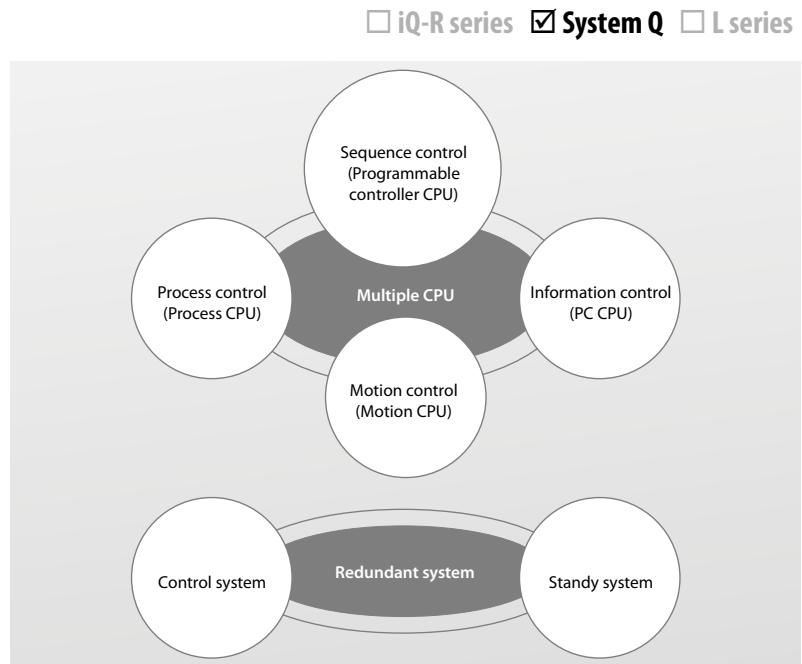

## Increased operation processing speeds and program capacities

Current production requirements are calling for an increase in productivity and carrying out production processes even faster due to an increase in production information such as production results and traceability. The MELSEC System Q series programmable controller “universal model QnU” offers some of the highest processing performance on the market today with a basic operation speed of up to 1.9 ns.

To construct small to large scale systems, the System Q series has a wide variation of CPU modules having 8k to 1000k step program capacities to meet the application requirements from basic sequence control up to complex multi-discipline applications.

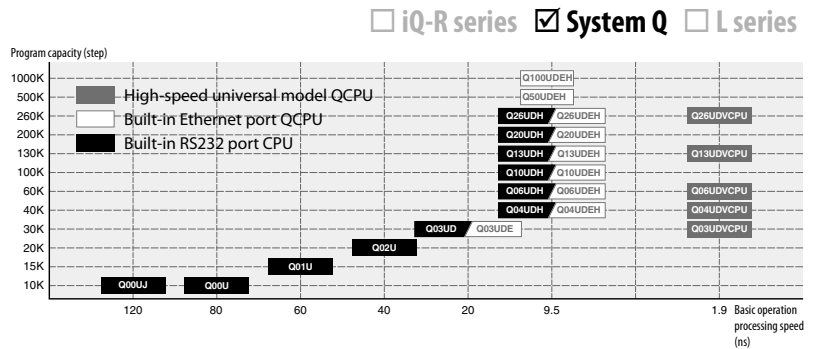

## Multiple CPU system configuration

iQ-R series  System Q  L series

The System Q series can combine multiple CPUs together on the same system to build the required application configuration. Control of I/O modules can be segmented between different CPUs. CPUs communicate with each other via shared memory, and can increase system performance by distributing tasks between different CPUs. A variety of methods exist for controlling the methods by which CPUs communicate, but in each case the development effort is simplified by available software tools.

\* The redundant CPU does not support the multiple CPU.

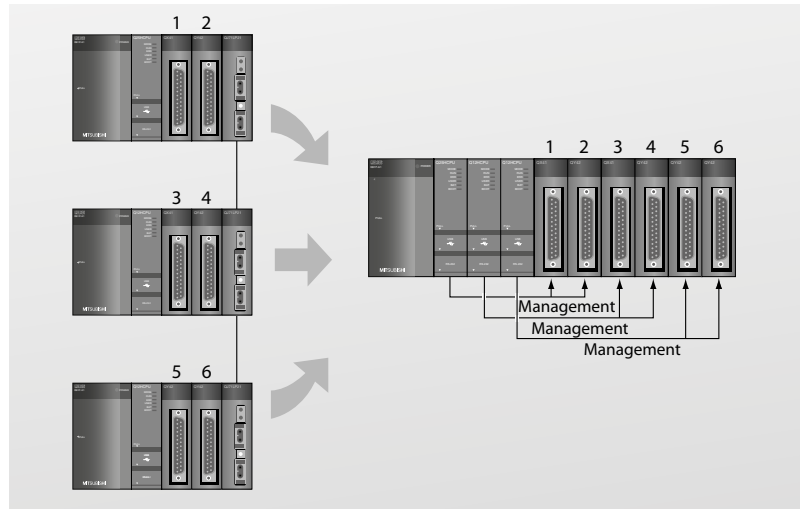

Up to 4 CPUs can be installed.

Modules are managed CPU-by-CPU.

Use standard System Q series I/O and intelligent function modules (there are restrictions on the number and versions).

## Integration of Process CPU, Motion CPU and PC CPU

iQ-R series  System Q  L series

The System Q series multiple CPU system function allows programmable controller CPU, process, motion, and personal computer CPUs to be mounted together, enabling utilization of their respective strong points and design of an optimal system.

Note: Only the following combinations can be used with the basic model.

- Basic model CPU + Motion CPU
- Basic model CPU + PC CPU
- Basic model CPU + Motion CPU + PC CPU

\* SSCNET is a high-speed serial communication network that links motion CPUs and servo amplifiers with less wiring. SSCNET & SSCNETII are metal cable types, and SSCNETIII is a fiber optic cable type

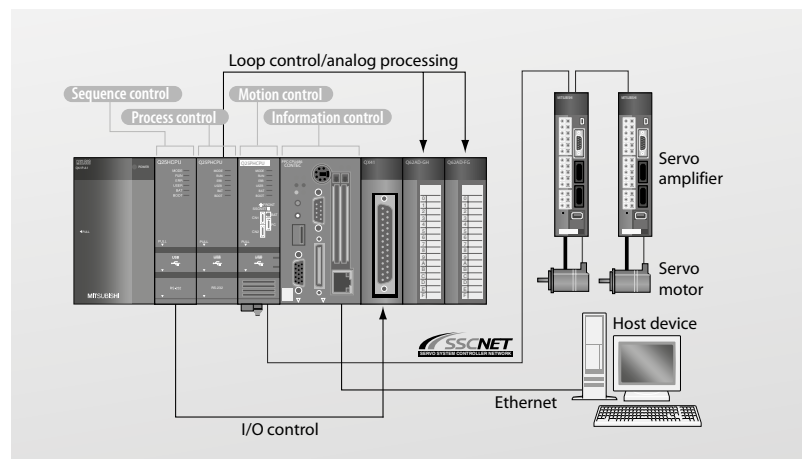

# MELSEC L series – advanced built-in functions

1 Modular overview

## ■ Built-in I/O features

iQ-R series  System Q  L series

Every MELSEC L series CPU comes with 24 points of built-in I/Os as standard. These I/O points are capable of many functions usually reserved for separate modules. System costs can be saved by using the built-in functions rather than relying exclusively on additional modules.

Function		Features
Positioning*	Control of maximum two axes	Maximum speed: 200 kpulse/s High-speed activation: 30 μs (shortest activation time) S-curve acceleration and deceleration are supported
High-speed counter*	Two built-in channels	Maximum counting speed: 200 kpulse/s Open collector, differential line driver input High accuracy ON/OFF measurements with a resolution of 5 μs High precision PWM control up to 200 kHz (High-speed pulse output)
Pulse catch	16 input points	Minimum input response time: 10 μs Pulse signals whose ON time is shorter than the scan time can be detected.
Interrupt input	16 interrupt input points	Built-in CPU provides high-speed processing. All input points support interrupt inputs.
General input	6 high-speed input points, 10 standard input points	Minimum input response time of high-speed input: 10 μs Minimum input response time of standard input: 100 μs
General output	8 output points	Output response time: 1 μs or less

\* Points used by the positioning and high-speed counting functions are fixed (as in A phase, B phase, near-point dog). Custom points for these functions may not be assigned.

## ■ Built-in CPU positioning control function

iQ-R series  System Q  L series

### Positioning function

The built-in positioning function has a start time of just 30 μs with a maximum high-speed output of 200 k pulses per second.

Furthermore, it supports S-curve acceleration and deceleration for applications that require minimal machine vibration.

### High-speed counter function

Two channels support the high-speed counting function. The differential line driver inputs support counting speeds up to 200 k pulses per second.

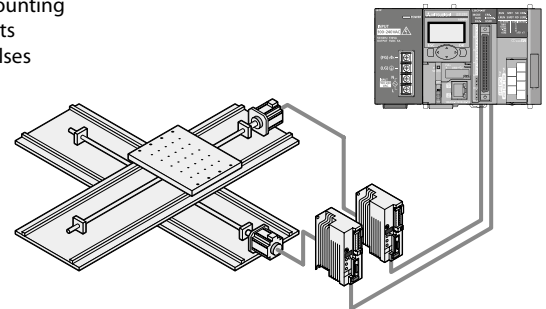

### High-speed data sampling

The high-speed data logging function has the power to synchronize with the sequence program scan, ensuring that every value available to the program is logged for analysis.

Using this method it is possible to perform detailed operational analysis and identify existing or potential problems.

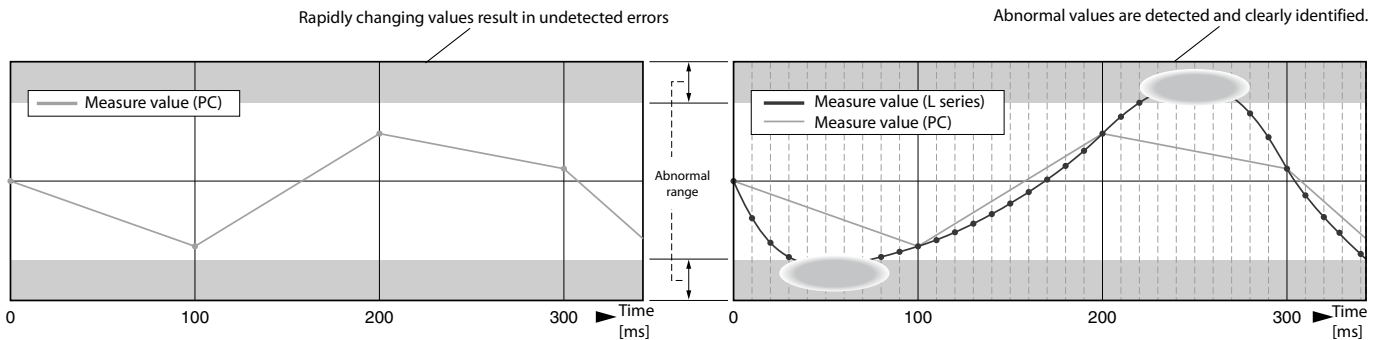

Generic sample data from a PC or external device at 100 ms intervals

L series data logging function is capable of sampling data at much higher resolutions to detect quickly changing values.

**Make highly accurate measurements with a resolution of 5 μs**

Using pulse measurement mode, where the input signal ON/OFF time is 200 μs or greater, highly accurate measurements in units of 5 μs or greater are possible. For example it is possible to calculate length by knowing the “work object passing speed” and measuring the ON time of the sensor.

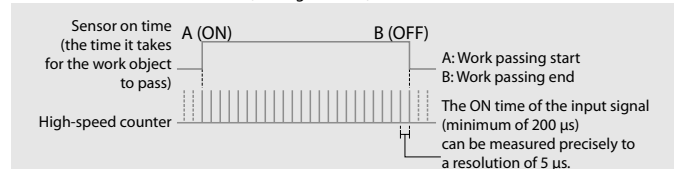
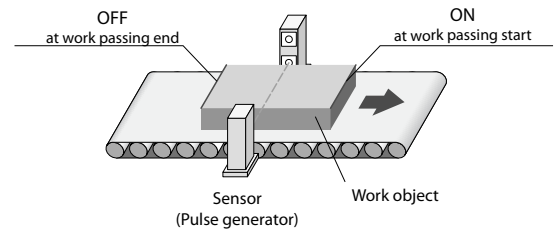

**High precision PWM control up to 200 kHz**

Using the pulse width modulation control function of the high-speed outputs, cycle times as fast as 5 μs can be created. Simply input the ON time and cycle time to drive a wide range of devices from lighting dimmer control, motors, and heaters to precision inspection equipment requiring high resolution performance.

	Setting Range	Description
PWM output ON time*	0 or 10 to 10000000 * [0.1 μs]	Set the ON time of output pulse
PWM output cycle time*	50 to 1000000 * [0.1 μs]	Set the cycle time of output pulse

\*The PWM output ON time must be ≤ the PWM output cycle time.

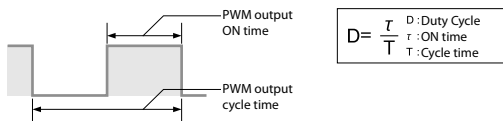

**Lighting dimmer control using PWM output**

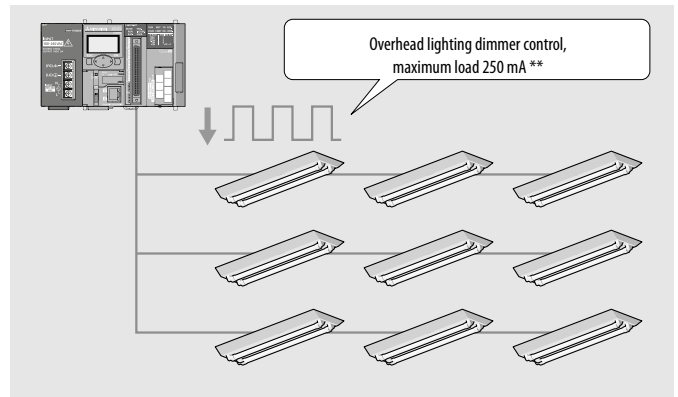

\*\* In cases where the first six digits of the serial number are “120722” or later. Previous serial numbers of the CPU module are applied to 100 mA.

**Guaranteed input pulse detection**

Typical PLC input devices are unable to detect pulse signals whose ON time is shorter than the scan time or do not occur during I/O refresh periods. The pulse catch function allows these signals to be reliably detected and passed to the sequence program. This function is different from the interrupt input function in that it does not require any special programming. Pulse catch inputs may be used in programs exactly the same as traditional input (X) signals.

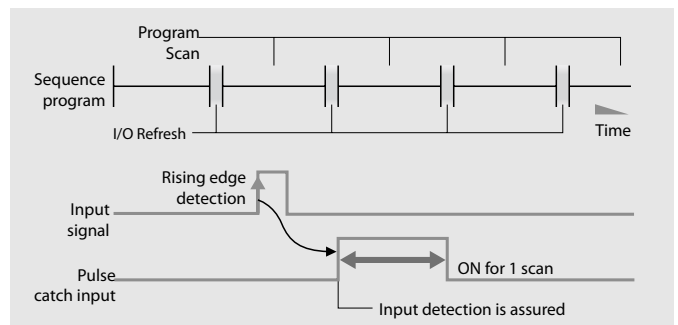

**Data logging function**

The built-in data logging function provides an easy way to collect information for troubleshooting, performance evaluation, and other uses. The included configuration tool makes setting up the data logging function a breeze with a step-by-step wizard like interface. Using GX LogViewer, the captured data is easy to interpret and understand.

Make the desired settings on each screen and click the **Next** button until all settings are complete.

**Configuration tool**

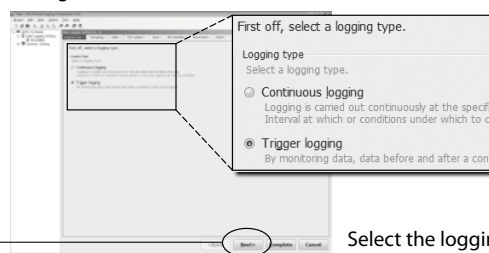

Select the logging type.

## MELSEC iQ-R series

### Revolutionary, next-generation controllers building a new era in automation

To succeed in highly competitive markets, it's important to build automation systems that ensure high productivity and consistent product quality. The MELSEC iQ-R series has been developed from the ground up based on common problems faced by customers and rationalizing them into seven key areas: productivity, engineering, maintenance, quality, connectivity, security and compatibility. Mitsubishi Electric is taking a three-point approach to solving these problems: Reducing TCO <sup>①</sup>, increasing reliability and reuse of existing assets.

As a bridge to the next generation in automation, the MELSEC iQ-R series is a driving force behind revolutionary progress in the future of manufacturing.

① Total Cost of Ownership

- System design flexibility with integrated safety control
- Improve productivity through advanced performance/ functionality
- Reducing development costs through intuitive engineering

- Reduce maintenance costs and downtime utilizing easier maintenance features
- Reliable and trusted MELSEC product quality
- Extensive data handling from shop floor to business process systems
- Seamless network reduces system costs
- Robust security that can be relied on
- Extensive compatibility with existing products

### What a system looks like

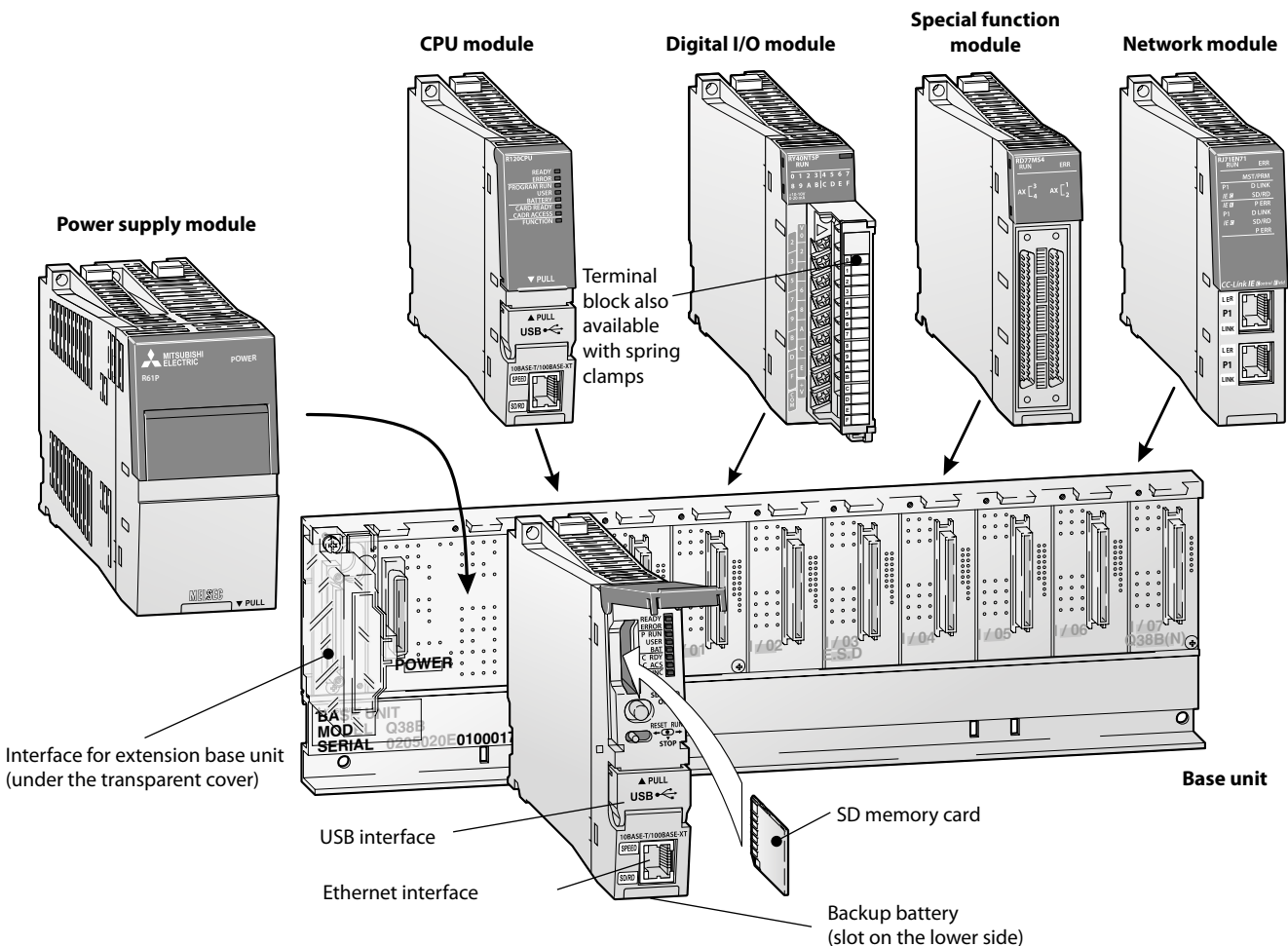

### System structure

The CPU and modules are connected to a base unit which has an internal bus connection for high-speed communication between the individual modules and the CPUs. A power supply module which supplies the voltage for the entire modules is also installed on this base unit.

The base units are available in different versions with 5 to 12 module slots.

Each base unit can be supplemented by means of an extension unit providing additional slots. Up to seven extension base units can be connected and a maximum of 64 modules installed at any one time. An RQ extension base unit is also available, ensuring compatibility with existing MELSEC System Q modules.

For cabling larger systems and machines – e.g. in a modular design – the use of remote I/O modules offers additional communications facilities

## ■ Base and extension base units

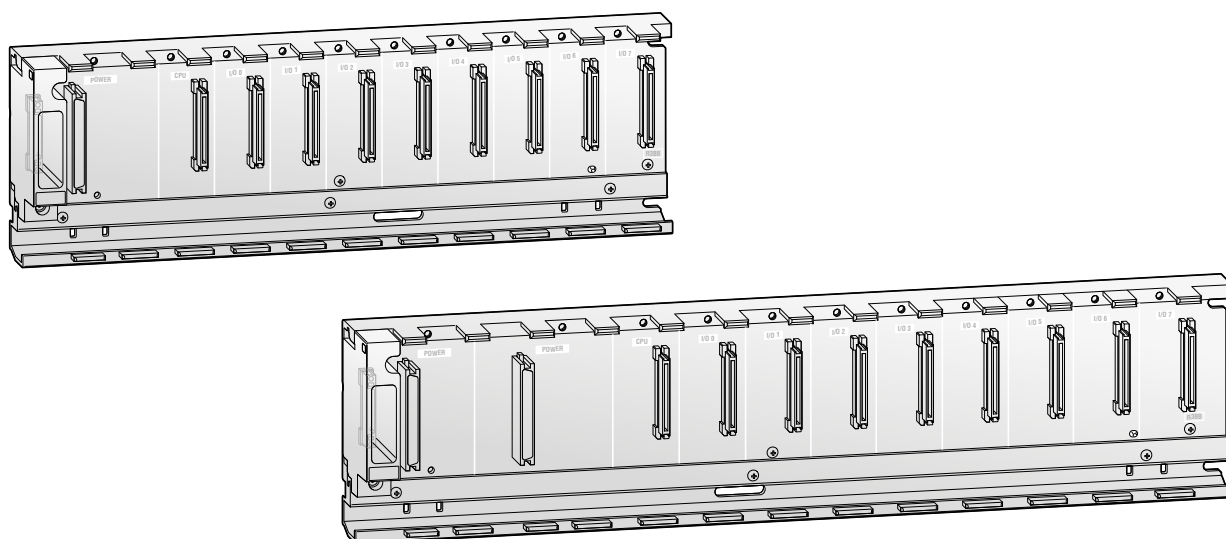

### Main base units (Standard, extended temperature range)

The main base unit is used for mounting and connecting up to four CPUs, power supply unit, input modules, output modules and special function modules.

#### Special features:

- Enables the installation of redundant power supply modules (only “RB” models)
- Standard (0–55 °C) and extended temperature range models (0–60 °C) available
- Utilize standard MELSEC iQ-R series modules

Specifications	R35B	R38B	R310RB	R312B	R310B-HT	R38RB-HT	
Slots for I/O modules	5	8	10	12	10	8	
Slots for power supply modules	1	1	2	1	1	2	
Installation	All base units provide installation holes for M4 screws. Adapter for DIN rail mounting are available.						
Dimensions (WxHxD)	mm	245x101x32.5	328x101x32.5	439x101x32.5	439x101x32.5	439x101x32.5	
Order information	Art. no.	279583	279584	301652	279585	308780	301650

### Extension base units (Standard, extended temperature range), RQ extension base unit

The extension base units are connected to the main base unit by means of preassembled bus cables. The RQ extension base units are for MELSEC System Q modules.

#### Special features:

- Enables the installation of redundant power supply modules (only “RB” models)
- Standard (0–55 °C) and extended temperature range models (0–60 °C) available
- Utilize standard MELSEC iQ-R series modules

Specifications	R65B	R68B	R610RB	R612B	RQ65B	RQ68B	RQ612B	R610B-HT	R68RB-HT	
Slots for I/O modules	5	8	10	12	5	8	12	10	8	
Slots for power supply modules	1	1	2	1	1	1	1	1	2	
Installation	All base units provide installation holes for M4 screws. Adapter for DIN rail mounting are available.									
Dimensions (WxHxD)	mm	245x101x32	328x101x32.5	439x101x32.5	439x101x32.5	245x98x44.1	328x98x44.1	439x98x44.1	439x101x32.5	439x101x32.5
Order information	Art. no.	279590	279589	301653	279588	279591	279586	279587	308782	301651

## Power supply modules

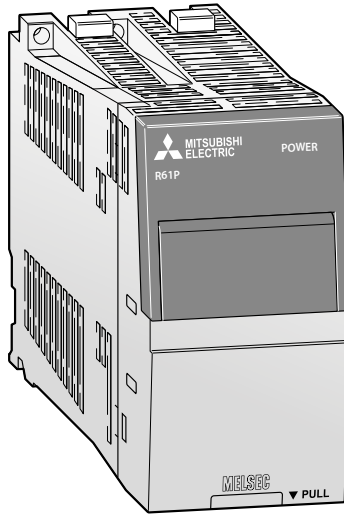

### Standard and redundant power supply modules

These units power all the modules mounted to a base unit. The choice is dependent on the power consumption of the individual modules (this is especially important when using multiple CPUs) and the available input power supply voltage.

#### Special features:

Standard module:

- Wide AC input voltage range
- The power supply R62P has an additional 24 V DC output for external devices.
- Contact output turns off in case of an error.

Redundant module:

- Two redundant power supplies on a redundant base unit are required for a redundant power supply configuration.
- Same size as standard power supply module
- Able to replace while on-line (hot-swap)
- Enables installation of up to two modules simultaneously on the same base unit

Specifications		R61P	R62P	R63P	R63RP	R64P*	R64RP
Input voltage	(+10%, -15%) V AC	100–240 (85–264)	100–240 (85–264)	—	—	100–240 (85–264)	100–240 (85–264)
	(+30%, -35%) V DC	—	—	24 (15.6–31.2)	24 (19.2–31.2)	—	—
Input frequency	Hz	50/60 (±5%)	50/60 (±5%)	—	—	50/60 (±5%)	50/60 (±5%)
Inrush current		20 A within 8 ms	20 A within 8 ms	100 A within 1 ms	100 A within 1 ms	20 A within 8 ms	20 A within 8 ms
Max. input apparent power	VA	130	120	—	—	160	160
Max. input power	W	—	—	50	50	—	50
Rated output current	5 V DC	A 6.5	A 3.5	A 6.5	A 6.5	A 9	A 9
	24 V DC ±10%	A —	A 0.6	A —	A —	A —	A —
Overcurrent protection	5 V DC	A ≥7.1	A ≥3.8	A ≥7.1	A ≥7.1	A ≥10.0	A ≥10.0
	24 V DC	A —	A ≥0.66	A —	A —	A —	A —
Overvoltage protection	5 V DC	V 5.5–6.6	V 5.5–6.6	V 5.5–6.6	V —	V 5.5–6.6	V —
Efficiency		≥76%	≥76%	≥70%	≥70%	≥76%	≥76%
Insulation withstand voltage		2830 V AC, 1 min.	2830 V AC, 1 min.	510 V AC, 1 min.	510 V AC, 1 min.	2830 V AC, 1 min.	2830 V AC, 1 min.
Max. compensation time at power failure	ms	20	20	10	10	20	20
Power indicator		All modules possess a power LED display.					
Terminal screw size		M4 (M3.5 for +24V and 24G terminals of the R62P)					
Applicable wire size	mm <sup>2</sup>	0.75–2	0.75–2	0.75–2	0.75–2	0.75–2	0.75–2
Weight	kg	0.41	0.45	0.41	0.41	0.46	0.46
Dimensions (WxHxD)	mm	54.6x106x110	54.6x106x110	54.6x106x110	54.6x106x110	54.6x106x11	54.6x106x110
<b>Order information</b>	Art. no.	279581	285507	279582	308710	285508	301649

\* Redundant power supply



## PLC CPU modules

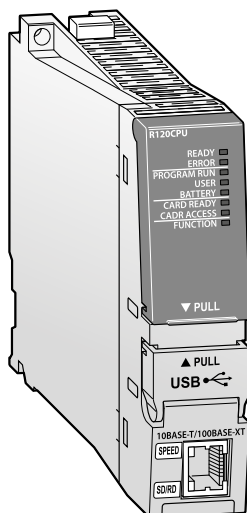

At the core of the MELSEC iQ-R series is a programmable controller CPU. This CPU is the heart of the control system and includes various features for different applications. The most common CPU is the programmable controller CPU, into which various features are embedded, enabling it to perform a wide range of control tasks.

### Special features:

- Highly scalable with five types available
- Built-in hardware features
- RnENCPU with built-in CC-Link IE port
- Flexible, large-capacity data storage
- Data management utilizing internal database (DB)
- High-speed, event driven programs
- CPU program management data
- Intuitive root cause analysis
- Easy collection of manufacturing data

Specifications			R04CPU R04ENCPU	R08CPU R08ENCPU	R16CPU R16ENCPU	R32CPU R32ENCPU	R120CPU R120ENCPU
Type	Programmable controller CPU						
I/O points	4096						
CPU self-diagnostic functions	CPU error detection, Watch Dog, battery error detection, memory error detection, program check, power supply error detection, fuse error detection						
Multiple CPU system	Up to 4 CPU modules can be used in combination on one base unit. A multiple CPU system can not be configured with a RnENCPU.						
Battery buffer	All CPU modules are fitted with a lithium-battery with a life expectancy of 5 years.						
Memory type	RAM, ROM, SD memory card						
Memory capacity for PLC program	40 k steps (160 kByte)						
Instruction processing time	LD instruction	ns	0.98	0.98	0.98	0.98	0.98
	MOV instruction	ns	1.96	1.96	1.96	1.96	1.96
	PC MIX value <sup>①</sup>	instructions/μs	419	419	419	419	419
Timer (T)	points	1024 (user-changeable)	1024 (user-changeable)	1024 (user-changeable)	1024 (user-changeable)	1024 (user-changeable)	1024 (user-changeable)
Counter (C)	points	512 (user-changeable)	512 (user-changeable)	512 (user-changeable)	512 (user-changeable)	512 (user-changeable)	512 (user-changeable)
Internal relay (M)	points	12288 (user-changeable)	12288 (user-changeable)	12288 (user-changeable)	12288 (user-changeable)	12288 (user-changeable)	12288 (user-changeable)
Data register/special register (D)	points	18432 (user-changeable)	18432 (user-changeable)	18432 (user-changeable)	18432 (user-changeable)	18432 (user-changeable)	18432 (user-changeable)
File register (R/ZR)	points	0 (user-changeable)	0 (user-changeable)	0 (user-changeable)	0 (user-changeable)	0 (user-changeable)	0 (user-changeable)
Interrupt pointer (I)	points	1024 (fixed)	1024 (fixed)	1024 (fixed)	1024 (fixed)	1024 (fixed)	1024 (fixed)
Pointer (P) (global/local) (default)	points	8192 (user-changeable, up to 24)	8192 (user-changeable, up to 24)	8192 (user-changeable, up to 24)	8192 (user-changeable, up to 24)	8192 (user-changeable, up to 24)	8192 (user-changeable, up to 24)
Annunciator (F)	points	2048 (user-changeable)	2048 (user-changeable)	2048 (user-changeable)	2048 (user-changeable)	2048 (user-changeable)	2048 (user-changeable)
Index register (Z)	points	20 (user-changeable, up to 24)	20 (user-changeable, up to 24)	20 (user-changeable, up to 24)	20 (user-changeable, up to 24)	20 (user-changeable, up to 24)	20 (user-changeable, up to 24)
Link relay (B)/link register (W)	points	8192 (user-changeable)	8192 (user-changeable)	8192 (user-changeable)	8192 (user-changeable)	8192 (user-changeable)	8192 (user-changeable)
Number of connectable extensions		7	7	7	7	7	7
Max. number of insertable modules		64	64	64	64	64	64
Internal power consumption (5 V DC)	A	RnCPU: 0.67 RnENCPU: 1.49					
Weight	kg	RnCPU: 0.20 RnENCPU: 0.40					
Dimensions (WxHxD)	mm	RnCPU: 27.8x106x110 RnENCPU: 56x106x110					
Order information	Art. no.	279576 290226	279577 290227	279578 290228	279579 290232	279580 290234	
Accessories	NZ1MEM-2GBSD; 2 GB SD memory card; NZ1MEM-4GBSD; 4 GB SDHC memory card; NZ1MEM-8GBSD; 8 GB SDHC memory card; NZ1MEM-16GBSD; 16 GB SDHC memory card; NZ2MC-1MBS; 1 MB extended SRAM cassette; NZ2MC-2MBS; 2 MB extended SRAM cassette; NZ2MC-4MBS; 4 MB extended SRAM cassette; NZ2MC-8MBS(E); 8 MB extended SRAM cassette; only supported by safety and process CPU; NZ2MC-16MBS; 16 MB extended SRAM cassette; safety CPU is not supported						

① Average number of instructions such as for basic instructions and data processing executed in 1 μs. The larger the value, the faster the processing speed.

■ Process CPU modules and redundant function module

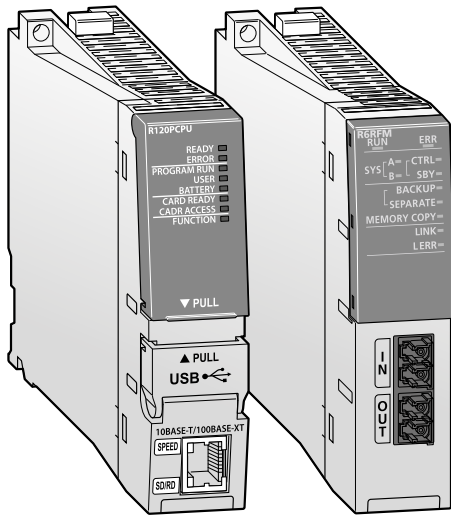

The MELSEC iQ-R process CPUs are designed specifically for medium- to large-scale process control systems requiring high-speed performance coupled with the handling of large PID loops.

When paired with a redundant function module, a highly reliable (redundant) control system can be realized with a tracking data capacity of up to 1 M words between the control and standby systems supported.

**Special features:**

- High availability process control system
- Excellent scalability with four models available (between 80–1200 k steps memory)
- Extensive visualization and data acquisition with Mitsubishi SCADA MC Works64
- Redundancy across multiple levels reduces single-point failures
- GX Works3\* integrated engineering software

Specifications	R08PCPU	R16PCPU	R32PCPU	R120PCPU
Type	Process CPU	Process CPU	Process CPU	Process CPU
I/O points	4096	4096	4096	4096
Multiple CPU system	Up to 4 CPU modules can be used in combination on one base unit.			
Battery buffer	All CPU modules are fitted with a lithium-battery with a life expectancy of 5 years.			
Memory type	RAM, ROM, SD memory card			
Memory capacity	5 MByte	10 MByte	20 MByte	40 MByte
for PLC program	80 k steps (320 kByte)	160 k steps (640 kByte)	320 k steps (1280 kByte)	1200 k steps (4800 kByte)
Instruction processing time	LD instruction ns 0.98	0.98	0.98	0.98
	MOV instruction ns 1.96	1.96	1.96	1.96
	PC MIX value <sup>①</sup> instructions/μs 419	419	419	419
Timer (T)	points 1024 (user-changeable)	1024 (user-changeable)	1024 (user-changeable)	1024 (user-changeable)
Counter (C)	points 512 (user-changeable)	512 (user-changeable)	512 (user-changeable)	512 (user-changeable)
Internal relay (M)	points 12288 (user-changeable)	12288 (user-changeable)	12288 (user-changeable)	12288 (user-changeable)
Data register/special register (D)	points 18432 (user-changeable)	18432 (user-changeable)	18432 (user-changeable)	18432 (user-changeable)
File register (R/ZR)	points 0 (user-changeable)	0 (user-changeable)	0 (user-changeable)	0 (user-changeable)
Interrupt pointer (I)	points 1024 (fixed)	1024 (fixed)	1024 (fixed)	1024 (fixed)
Pointer (P) (global/local) (default)	points 8192 (user-changeable, up to 24)	8192 (user-changeable, up to 24)	8192 (user-changeable, up to 24)	8192 (user-changeable, up to 24)
Annunciator (F)	points 2048 (user-changeable)	2048 (user-changeable)	2048 (user-changeable)	2048 (user-changeable)
Index register (Z)	points 20 (user-changeable, up to 24)	20 (user-changeable, up to 24)	20 (user-changeable, up to 24)	20 (user-changeable, up to 24)
Link relay (B)/link register (W)	points 8192 (user-changeable)	8192 (user-changeable)	8192 (user-changeable)	8192 (user-changeable)
Number of connectable extensions	7 (In a redundant system, no extension base units can be connected.)			
Max. number of insertable modules	Up to 64 (up to 11 in a redundant system)			
Internal power consumption (5 V DC)	A 0.76	0.76	0.76	0.76
Max. compensation time at power failure	ms The time differs depending on the power supply module used.			
Weight	kg 0.20	0.20	0.20	0.20
Dimensions (WxHxD)	mm 27.8x106x110	27.8x106x110	27.8x106x110	27.8x106x110
<b>Order information</b>	Art. no. 285496	285499	285500	285497

① Average number of instructions such as for basic instructions and data processing executed in 1 μs. The larger the value, the faster the processing speed.

Specifications	R6RFM
Type	Redundant process CPU
Occupied I/O points	32
Communication cable	Multi-mode optical cable
Max. distance	m 550 (when the core outer diameter is 50 μm)
Tracking cable data capacity (word)	1 M
Optical fiber specifications	Standard: IEEE802.3, IEC 60793-2-10 (Types A1a.1)
Connector specifications	Duplex LC connector
Laser class (IEC60825-1)	Class 1 laser product
Internal power consumption (5 V DC)	A 0.88
Weight	kg 0.18
Dimensions (WxHxD)	mm 27.8x106x110
<b>Order information</b>	Art. no. 301648

## ■ C Controller CPU

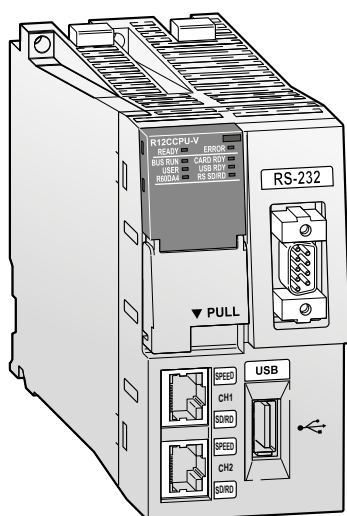

### C Controller CPU

The C Controller module is part of the application-specific range in the MELSEC iQ-R series. The multi-core ARM®-based controller pre-installed with VxWorks® Version 6.9, realizes the simultaneous execution of programs, thereby providing a robust and deterministic alternative to computer based systems.

#### Special features:

##### Easy setup using three simple tools

- Easy programming
- Parameter setup/diagnosis/monitoring with CW Configurator
- Application development in simple steps

Specifications		R12CCPU-V
Number of I/Os		4096
Endian format		Little endian
MPU		ARM® Cortex-A9 Dual Core
Memory		Work RAM: 256 MB; ROM: 12 MB; Battery-backed-up RAM: 4 MB
Operating system		VxWorks Version 6.9
Programming language		C or CC++
Development tool		CW Workbench and CW-Sim
Communication interfaces		Ethernet 110BASE-T/100BASE-TX (2 ch.), RS232 (1 ch.)
SD memory card slot		1 slot
Ethernet port	No. of channels	2
	Interface	10BASE-T/100BASE-TX/1000BASE-T
	Data transmission rate	10BASE-T: 10 Mbps/100BASE-TX: 100 Mbps/1000BASE-T: 1 Gbps
	No. of cascaded connections <sup>①</sup>	10BASE-T: max. 4/100BASE-TX: max. 2/1000BASE-T: —
	Maximum segment length	m 100 (distance between hub and node)
	Communication method	Full-duplex/half-duplex
	Transmission method	Base band
	Applicable connector for external wiring	RJ45
	Supported function	Auto-negotiation function (automatic recognition of communication speed/communication method) Auto-MDI/MDI-X (automatic recognition of straight/crossing cable)
	IP version	IPv4 supported
RS232 connector	No. of channels	1
	Interface	RS232-compliant
	Communication method	Full-duplex/half-duplex
	Synchronization method	Asynchronous communication
	Transmission rate	bps 9600, 14400, 19200, 28800, 38400, 57600, 115200
	Transmission distance	m Up to 15
	Data format	1 start bit, 7 or 8 data bits, 1 or 0 parity bits, 1 or 2 stop bits
	Parity check	Yes (Even/Odd)/None
	Sum check code	Yes/None
Transmission control	Flow control (RS/CS control)	
Integrated clock		Year, month, day, minute, second, weekday (automatic leap year adjustment)
Max. compensation time at power failure		Depends on power supply
Internal power consumption (5 V DC)		A 1.26
Weight		kg 0.35
Dimensions (WxHxD)		mm 56x106x110
Order information		Art. no. 285498

① This number applies when a repeater hub is used. When using a switching hub, check the number of cascaded stages with the manufacturer of the hub used.

■ Motion CPU modules

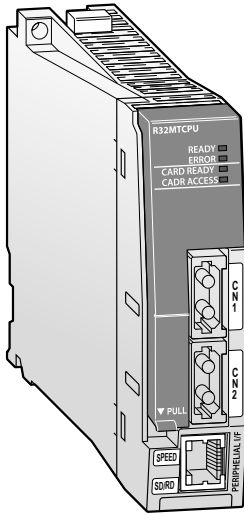

**Motion CPUs for advanced applications**

The motion CPU module is a dedicated high-precision control CPU module, designed solely for applications that require advanced motion control such as positioning control, synchronous control, and speed-torque control at a very high accuracy. A motion system requires a motion controller CPU and a PLC CPU. Only after combining a highly dynamic positioning control CPU and a PLC, an innovative Motion Control system is created.

**Special features:**

- Large scale control system for up to 192 axes per system
- Up to 3 motion CPU modules can be mounted in one system
- High-speed data communication between CPUs via a large bandwidth data buffer memory exchange.
- Various different applications easily realized
- SFC (Sequential Function Chart) type language enables programming in clearly identifiable steps
- Integration in the high-speed SSCNETIII/H network for communication with high-performance servo amplifiers at up to 150 Mbps

Specifications	R16MTCPU	R32MTCPU	R64MTCPU
Type	Motion CPU	Motion CPU	Motion CPU
I/O points	8192	8192	8192
No. of control axes	16	32	64
Interpolation functions	Linear interpolation for up to 4 axes, circular interpolation for 2 axes, helical interpolation for 3 axes		
Positioning	Method	PTP (point to point), speed control/speed-position control, fixed pitch feed, constant speed control, position follow-up control, speed switching control, high-speed oscillation control, synchronous control (SV22)	
	Acceleration/deceleration control	Automatic trapezoidal acceleration/deceleration, S-curve acceleration/deceleration	
	Compensation	Backlash compensation, electronic gear	
Programming language	Motion SFC, dedicated instruction		
Servo program capacity	32 k steps	32 k steps	32 k steps
No. of positioning points	6400	6400	6400
Servo amplifier network	SSCNETIII/H (1 line)	SSCNETIII/H (2 lines)	SSCNETIII/H (2 lines)
Max. distance between stations	m 100	100	100
Interfaces	Ethernet 100/10 Mbps, SSCNETIII/H (USB, RS232C via PLC CPU), PERIPHERAL I/F, SD memory card		
Servo amplifier	MR-J4-B over SSCNETIII/H		
Operation cycle	ms 0.222, 0.444, 0.888, 1.777, 3.555, 7.111		
Internal power consumption (5 V DC)	A 1.20	1.20	1.20
Weight	kg 0.28	0.28	0.28
Dimensions (WxHxD)	mm 27.8x106x110	27.8x106x110	27.8x106x110
<b>Order information</b>	Art. no. 280227	280288	295076

## ■ Safety function module and safety CPU

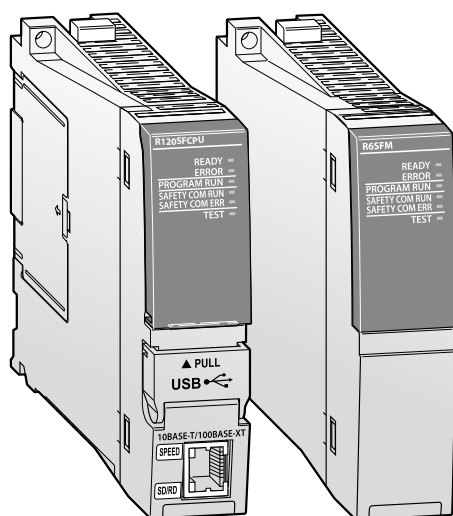

### Safety function module

The safety function module must be mounted next to the iQ-R safety CPU module. It is included with the purchase of an iQ-R safety CPU set, and cannot be purchased independent from the set.

Specifications	R65FM	
I/O points	16	
Control method	Stored program cyclic operation	
Memory capacity	Program capacity	40 k steps (160 kByte)
	Program memory	160 kByte
	Device/label memory	80 kByte
Buffer memory	4096 kByte	
Max. compensation time at power failure	Depends on power supply	
Internal power consumption (5 V DC)	A 0.67	
Weight	kg 0.16	
Dimensions (WxHxD)	mm 27.8x106x110	

Note: This product ships as part of the R□SFCPU-SET.

### Generic and safety control in one CPU

The safety CPU module enables control of both generic and safety programs in the same module and is easily programmed utilizing the intuitive features of GX Works3. Compliant with internationally recognized safety standards, the safety CPU enables safety devices such as safety light curtains, emergency switches, and door switches to be connected via the CC-Link IE Field network without requiring a separate dedicated network line.

The safety CPU can be installed directly on the MELSEC iQ-R series base rack, and is easily integrated into an existing or new control system. Safety devices are connectable using the CC-Link IE Field network with safety communication integrated into the network protocol over a widely-available industrial Ethernet topology. The safety CPU is compliant with ISO 13849-1 PL e and IEC 61508 SIL 3 and is certified by TÜV Rheinland®.

### Common engineering platform:

Various useful features of GX Works3 are also available for safety programs similar to other control programs

Specifications	R08SFCPU-SET <sup>①</sup>	R16SFCPU-SET <sup>①</sup>	R32SFCPU-SET <sup>①</sup>	R120SFCPU-SET <sup>①</sup>	
Safety integrity level (SIL)	SIL 3 (IEC 61508)				
Performance level (PL)	PL e (EN/ISO 13849-1)				
Control method	Stored program cyclic operation				
I/O control mode	Refresh mode (Direct access I/O is available by specifying direct access I/O (DX, DY).)				
Programming language	Ladder diagram (LD), structured text (ST) <sup>②</sup> , function block diagram (FBD) <sup>②</sup>				
Extended programming language	Function block (FB), label programming (system/local/global)				
Program execution type	Initial <sup>②</sup> , scan <sup>②</sup> , fixed scan, interrupt <sup>②</sup> , standby type <sup>②</sup>				
Memory capacity	Program capacity	80 k steps (40 k steps for safety programs)	160 k steps (40 k steps for safety programs)	320 k steps (40 k steps for safety programs)	1200 k steps (40 k steps for safety programs)
	Program memory	320 kByte	640 kByte	1280 kByte	4800 kByte
	Device/label memory	1178 kByte	1710 kByte	2306 kByte	3370 kByte
	Data memory	5 MByte	10 MByte	20 MByte	40 MByte
USB Port	USB2.0 high-speed (miniB) x 1				
Integrated clock	Year, month, day, minute, second, weekday (automatic leap year adjustment)				
Max. compensation time at power failure	Depends on power supply				
Internal power consumption (5 V DC)	A 0.76	0.76	0.76	0.76	
Weight	kg 0.20	0.20	0.20	0.20	
Dimensions (WxHxD)	mm 27.8x106x110	27.8x106x110	27.8x106x110	27.8x106x110	
<b>Order information</b>	Art. no. 289989	290199	290200	290201	

① Product package includes a safety CPU(R□SFCPU) and safety function module (R65FM).

② Only for executing control programs.

■ Digital (high-speed) input modules

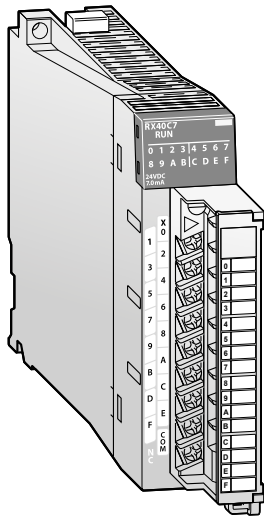

**Digital input modules**

Digital I/O modules are the senses of the automation system and provide an interface of various processes to the controller.

I/O modules are available in a wide range of densities (16, 32 and 64-points) depending on the I/O requirements and minimum use of space in the control cabinet.

Terminal blocks are interchangeable with MELSEC System Q I/O terminals and can save on the cost of upgrading from existing control systems.

**Special features:**

- Input interrupt function available
- Existing 16-point terminal blocks are reusable
- Response time as fast as 0.1 ms
- Nearly all modules can be wired using either positive or negative common terminals.
- The input module RX40NC6B (with diagnostic function) offers
  - input disconnection detection
  - interrupt function in case of an error
  - error and event history function

Specifications	RX10	RX28	RX40C7	RX40PC6H*/RX40NC6H*	RX40NC6B
Input points	16	8	16	16	16
Input type	AC input	AC input	DC input (positive or negative common)	DC high-speed input (RX40PC6H: positive common RX40NC6H: negative common)	DC input (negative common) with diagnostic functions
Rated input voltage	100–120 V AC (50/60 Hz)	100–120 V AC (50/60 Hz)	24 V DC	24 V DC	24 V DC
Operating voltage range	85–132 V AC	85–132 V AC	20.4–28.8 V DC	20.4–28.8 V DC	20.4–28.8 V DC
Max. simultaneously ON (at rated voltage)	100 % (at 45 °C)	100 % (at 45 °C)	100 %	100 % (input voltage 26.4 V DC and 55 °C) 75 % (input voltage 28.8 V DC and 55 °C)	100 %
Inrush current	Max. 200 mA within 1 ms	Max. 950 mA within 1 ms	—	—	—
Input voltage distortion ratio	5 %	5 %	—	—	—
Rated input current	8.2 (100 V AC, 60 Hz) 6.8 (100 V AC, 50 Hz)	16.4 (AC 200 V, 60 Hz) 13.7 (AC 200 V, 50 Hz)	7.0	6.0	6.0
ON	Voltage V ≥AC 80 Current mA ≥5 (50 Hz, 60 Hz)	≥AC 80 ≥5 (50 Hz, 60 Hz)	≥15 ≥4	≥15 ≥4	≥14 ≥3.5
OFF	Voltage V ≤30 AC Current mA ≤1.7 (50 Hz, 60 Hz)	≤30 AC ≤1.7 (50 Hz, 60 Hz)	≤8 ≤2	≤8 ≤1.7	≤6 ≤1
Input impedance/resistance	kΩ Approx. 14.6 (50 Hz) Approx. 12.2 (60 Hz)	Approx. 14.6 (50 Hz) Approx. 12.2 (60 Hz)	3.3	3.9	4
Response time	≤20 ms	≤20 ms	0.1–70 ms <sup>①</sup>	5 μs–70 ms <sup>①</sup>	1 μs–70 ms <sup>①</sup>
Common terminal arrangement	points 16	8	16	8	16
Power and I/O status indicator	All modules possess a RUN LED and one status LED per input (Alternating toggle switch used to display between 32-point LED signals for 64-point type module.)				
Connection terminal	18-point removable terminal block with screws	18-point removable terminal block with screws	18-point removable terminal block with screws	18-point removable terminal block with screws	18-point removable terminal block with screws
Occupied I/O points	16	16	16	16	16
Applicable wire size	mm <sup>2</sup> 0.3–0.75	0.3–0.75	0.3–0.75	0.3–0.75	0.3–0.75
Internal power consumption (5 V DC)	mA 110	110	110	100	450
Weight	kg 0.18	0.18	0.16	0.16	0.25
Dimensions (WxHxD)	mm 27.8x106x131	27.8x106x131	27.8x106x131	27.8x106x131	27.8x106x131
<b>Order information</b>	Art. no. 279546	308711	279533	290235/290236	301646
<b>Accessories</b>	40-pin connector and ready to use connection cables; spring clamp terminal block for exchange against the standard screw terminal block > refer to chapter 5				

\* High-speed module  
① User adjustable

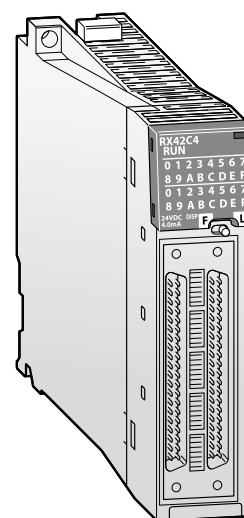
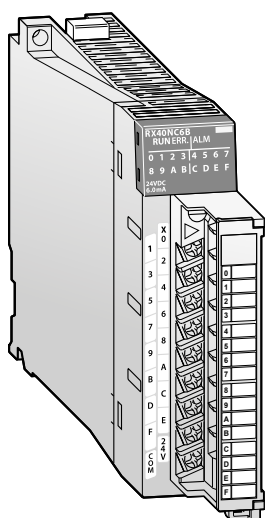

Specifications	RX41C4	RX41C6H5*	RX42C4	RX61C6H5*
Input points	32	32	64	32
Input type	DC input (positive or negative common)	DC high-speed input (positive or negative common)	DC input (positive or negative common)	DC high-speed input (positive or negative common)
Rated input voltage	24 V DC	24 V DC	24 V DC	5 V DC
Operating voltage range	20.4–28.8 V DC	20.4–28.8 V DC	20.4–28.8 V DC	4.25–6 V DC
Max. simultaneously ON (at rated voltage)	100 % (input voltage 26.4 V DC and 55 °C) 75 % (input voltage 28.8 V DC and 55 °C)	100 % (input voltage 24 V DC and 55 °C) 75 % (input voltage 26.4 V DC and 55 °C) 59.3 % (input voltage 28.8 V DC and 55 °C)	100 % (input voltage 24 V DC and 45 °C) 50 % (input voltage 26.4 V DC and 55 °C) 37.5 % (input voltage 28.8 V DC and 55 °C)	100 %
Inrush current	—	—	—	—
Input voltage distortion ratio	—	—	—	—
Rated input current	mA 4.0	6.0	4.0	6.0
ON	Voltage V $\geq 19$ Current mA $\geq 3$	$\geq 19$ $\geq 4$	$\geq 19$ $\geq 3$	$\geq 3.5$ $\geq 3$
OFF	Voltage V $\leq 6$ Current mA $\leq 1$	$\leq 6$ $\leq 1.7$	$\leq 6$ $\leq 1$	$\leq 1$ $\leq 1$
Input impedance/resistance	k $\Omega$ 5.3	4	5.3	0.6
Response time	0.1–70 ms <sup>①</sup>	1 $\mu$ s–70 ms <sup>①</sup>	0.1–70 ms <sup>①</sup>	1 $\mu$ s–70 ms <sup>①</sup>
Common terminal arrangement	points 32	32	32	32
Power and I/O status indicator	All modules possess a RUN LED and one status LED per input (Alternating toggle switch used to display between 32-point LED signals for 64-point type module.)			
Connection terminal	40-pin connector	40-pin connector	40-pin connector	40-pin connector
Occupied I/O points	32	32	64	32
Applicable wire size	mm <sup>2</sup> 0.088–0.3	0.088–0.3	0.088–0.3	0.088–0.3
Internal power consumption (5 V DC)	mA 150	150	180	150
Weight	kg 0.11	0.12	0.13	0.12
Dimensions (WxHxD)	mm 27.8x110x106	27.8x110x106	27.8x110x106	27.8x110x106
Order information	Art. no. 279534	307424	279545	304546
Accessories	40-pin connector and ready to use connection cables; spring clamp terminal block for exchange against the standard screw terminal block > refer to chapter 5			

\* High-speed module

① User adjustable

■ Digital (high-speed) output modules

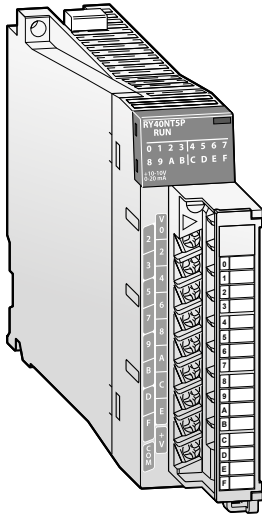

**Digital output modules**

A variety of digital output modules are available including relay, transistor sink (wired as positive common) and transistor source (wired as negative common). Load voltages include 240 V AC and 5 V to 24 V DC, with various current ratings.

**Special features:**

- Output modules with relays or transistor outputs
- Overload protection
- Connection of output signals via removable terminal blocks or connectors
- Relay health diagnostics for preventive maintenance
- The output module RY40PT5B (with diagnostic function) offers
  - output short-circuit and disconnection detection
  - interrupt function in case of an error
  - error and event history function.

Specifications	RY10R2	RY18R2	RY20S6	RY40NT5P	RY40PT5P	RY40PT5B
Output points	16	8	16	16	16	16
Output type	Relay	Relay	Triac	Transistor (sink)	Transistor (source)	Transistor with diagnostic functions (source)
Common terminal arrangement points	16	8	16	16	16	16
Insulation method	Relay	Relay	Photocoupler	Photocoupler	Photocoupler	Photocoupler
Rated output voltage	24 V DC/240 V AC	24 V DC/240 V AC	100–240 V AC	12–24 V DC	12–24 V DC	24 V DC
Operating voltage range	—	—	—	10.2–28.8 V DC	10.2–28.8 V DC	20.4–28.8 V DC
Min. switching load	5 V DC (1 mA)	5 V DC (1 mA)	24 V AC (100 mA) 100 V AC (25 mA) 240 V AC (25 mA)	—	—	—
Max. switching voltage	125 V DC/ 264 V AC	125 V DC/264 V AC	288 V AC	—	—	—
Max. output current A	2	2	0.6	0.5	0.5	0.5
Output current per group TYP A	8	8	4.8	5	5	5
Inrush current	—	—	—	Current is limited by the overload protection	Current is limited by the overload protection	Current is limited by the overload protection
Leakage current at OFF mA	—	—	≤1.5 (120 V AC), ≤3 (240 V AC)	≤0.1	≤0.1	≤0.3
Response time	OFF → ON	≤10 ms	≤10	≤0.5 ms	≤0.5 ms	≤0.5 ms
	ON → OFF	≤12 ms	≤12	≤1 ms	≤1 ms	≤1.5 ms
Life	Mechanical	Switching 20 million times	Switching 20 million times	—	—	—
	Electrical	Switching 300000 times or more	Switching 100000 times or more	—	—	—
Max. switching frequency	3600 times/h	3600 times/h	—	—	—	—
Surge suppression	—	—	CR absorber	Zener diode	Zener diode	Zener diode
Fuse	—	—	—	—	—	—
Power indicator	All modules possess a RUN LED and one status LED per output (Alternating toggle switch used to display between 32-point LED signals for 64-point type module.)					
Connection terminal	18-point removable terminal block with screws	18-point removable terminal block with screws	18-point removable terminal block with screws	18-point removable terminal block with screws	18-point removable terminal block with screws	18-point removable terminal block with screws
Occupied I/O points	16	16	16	16	16	16
Applicable wire size mm <sup>2</sup>	0.3–0.75	0.3–0.75	0.3–0.75	0.3–0.75	0.3–0.75	0.3–0.75
Ext. power supply	Voltage	—	—	12–24 V DC	12–24 V DC	24 V DC
	Current mA	—	—	4 (at 24 V DC)	16 (at 24 V DC)	87 (at 24 V DC)
Internal power consumption (5 V DC) mA	450	430 (all output points ON)	250 (all output points ON)	140	130	190
Weight kg	0.22	0.22	0.40	0.16	0.16	0.24
Dimensions (WxHxD) mm	27.8x106x131	27.4x98x90	27.4x98x112	27.8x106x131	27.8x106x131	27.8x106x131
<b>Order information</b>	Art. no. 279550	308712	308676	279547	279551	301647
<b>Accessories</b>	40-pin connector and ready to use connection cables; spring clamp terminal block for exchange against the standard screw terminal block > refer to chapter 5					



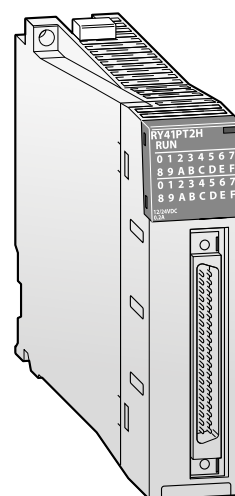
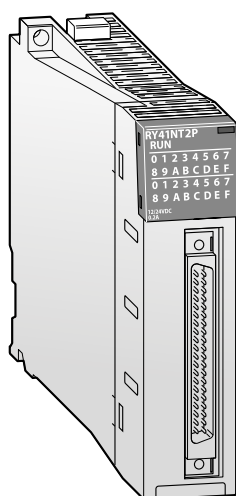

Specifications	RY41PT1P	RY41NT2H*	RY41NT2P	RY41PT2H*	RY42NT2P	RY42PT1P
Output points	32	32	32	32	64	64
Output type	Transistor (source)	Transistor (sink)	Transistor (sink)	Transistor (source)	Transistor (sink)	Transistor (source)
Common terminal arrangement	points	32	32	32	32	32
Insulation method	Photocoupler	Photocoupler	Photocoupler	Photocoupler	Photocoupler	Photocoupler
Rated output voltage	12–24 V DC	5–24 V DC	12–24 V DC	5–24 V DC	12–24 V DC	12–24 V DC
Operating voltage range	10.2–28.8 V DC	4.25–28.8 V DC	10.2–28.8 V DC	4.25–28.8 V DC	10.2–28.8 V DC	10.2–28.8 V DC
Min. switching load	—	—	—	—	—	—
Max. switching voltage	—	—	—	—	—	—
Max. output current	A 0.1	0.2	0.2	0.2	0.2	0.1
Output current per group TYP	A 2	2	2	2	2	2
Inrush current	Current is limited by the overload protection	0.7 A for max. 10 ms	Current is limited by the overload protection	0.7 A for max. 10 ms	Current is limited by the overload protection	Current is limited by the overload protection
Leakage current at OFF	mA ≤0.1	≤0.1	≤0.1	≤0.1	≤0.1	≤0.1
Response time	OFF → ON	≤0.5 ms	≤1 μs	≤0.5 ms	≤1 μs	≤0.5 ms
	ON → OFF	≤1 ms	≤2 μs	≤1 ms	≤2 μs	≤1 ms
Life	Mechanical	—	—	—	—	—
	Electrical	—	—	—	—	—
Max. switching frequency	—	—	—	—	—	—
Surge suppression	Zener diode	Zener diode	Zener diode	Zener diode	Zener diode	Zener diode
Fuse	—	—	—	—	—	—
Power indicator	All modules possess a RUN LED and one status LED per output (Alternating toggle switch used to display between 32-point LED signals for 64-point type module.)					
Connection terminal	40-pin connector	40-pin connector	40-pin connector	40-pin connector	40-pin connector	40-pin connector
Occupied I/O points	32	32	32	32	32	64
Applicable wire size	mm <sup>2</sup> 0.088–0.3	0.088–0.3	0.088–0.3	0.088–0.3	0.088–0.3	0.088–0.3
Ext. power supply	Voltage	12–24 V DC	—	12–24 V DC	—	12–24 V DC
	Current	mA 19 (at 24 V DC)	—	16 (at 24 V DC)	—	16 (at 24 V DC)
Internal power consumption (5 V DC)	mA 190	420	180	410	250	290
Weight	kg 0.11	0.12	0.11	0.12	0.13	0.13
Dimensions (WxHxD)	mm 27.8x110x106	27.8x110x106	27.8x110x106	27.8x110x106	27.8x110x106	27.8x110x106
Order information	Art. no. 279552	308707	279548	304547	279549	279553

**Accessories** 40-pin connector and ready to use connection cables; spring clamp terminal block for exchange against the standard screw terminal block > refer to chapter 5

\* High-speed module

■ Combined I/O module

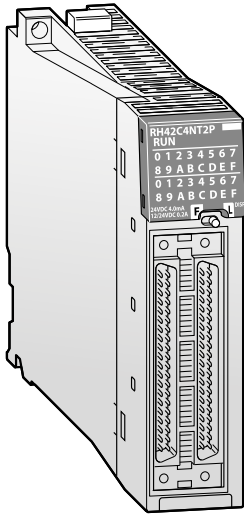

**Combined I/O module**

In addition to dedicated digital input and output modules, if only a few I/O points are required, a combined I/O module is available. This is an excellent alternative for cost-sensitive applications.

**Special features:**

- Input response time adjustable
- Connection of input and output signals via two 40-pin connectors
- Switch for alternating between indication of input or output status
- Output overload protection
- Overheat protection
- Input interrupt function

Specifications		RH42C4NT2P	
<b>DC input</b>			
Input points			32
Rated input voltage	V DC		24
Rated input current	mA		4 (at 24 V DC)
ON	Voltage	V	≥19
	Current	mA	≥3
OFF	Voltage	V	≤6
	Current	mA	≤1
Input resistance ?		kΩ	5.3
Response time	OFF → ON	ms	0.1–70 ms (user adjustable)
	ON → OFF	ms	0.2–70 ms (user adjustable)
<b>Transistor (sink) output</b>			
Output points			32
Rated output voltage	V DC		12–24 V DC
Max. output current	A		0.2/point, Pilot Duty, 2/common
Maximum inrush current			Current is limited by the overload protection
Response time	OFF → ON	ms	≤5
	ON → OFF	ms	≤1
Fuse			—
External power supply	Voltage		12–24 V DC
	Current	mA	16 (at 24 V DC)
Protection functions			Overload protection, overheat protection
<b>Common</b>			
Common terminal arrangement	points		32
Noise suppression	MΩ		10
Connection terminal			40-pin connector
Internal power consumption (5 V DC)	mA		220
Weight	kg		0.13
Dimensions (WxHxD)	mm		27.8x106x110
<b>Order information</b>	Art. no.		279554
<b>Accessories</b>	40-pin connector and ready to use connection cables; spring clamp terminal block for exchange against the standard screw terminal block > refer to chapter 5		

## ■ Analog (high-speed) input modules

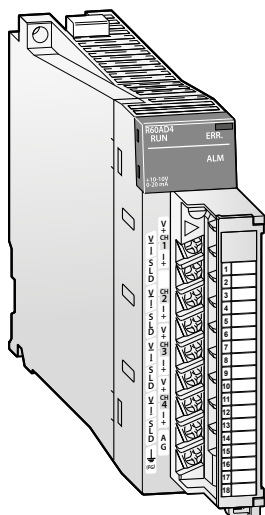

MELSEC iQ-R series analog modules are the interface between external analog signals and the control system. Various modules are available to cover a wide range of requirements.

### Special features:

- Up to 16 channels per module
- 5  $\mu$ s high-speed sampling, 16-bit high resolution (1/32,000)
- High-frequency noise filtering
- Enhanced alarm and warning features
- Data logging function
- Scaling and shifting of digital values without any programs
- Galvanic channel isolation
- Ideal for high-speed precision inspection applications
- Synchronization of multiple channels

Specifications		R60AD4	R60ADV8	R60ADI8	R60AD8-G	R60AD16-G	R60ADH4*
Input points		4	8	8	8	16	4
Analog input	Voltage	V	-10–10	—	-10–10	-10–10	-10–10
	Current	mA	0–20	—	0–20	0–20	0–20
Resolution		16-bit, signed binary	16-bit, signed binary	16-bit, signed binary	16-bit, signed binary	16-bit, signed binary	16-bit, signed binary
Load resistance	Voltage	M $\Omega$	1	—	1	1	1
	Current	$\Omega$	250	—	250	250	250
Max. input	Voltage	V	$\pm$ 15	—	$\pm$ 15	$\pm$ 15	$\pm$ 15
	Current	mA	30	—	30	30	30
I/O characteristics	Digital output (Voltage input)		-32000–32000	—	-32000–32000	-32000–32000	-32000–32000
	Digital output (Current input)		0–32000	—	0–32000	0–32000	0–32000
Max. resolution	Voltage input		47.7 $\mu$ V	—	29.2 $\mu$ V	29.2 $\mu$ V	125.0 $\mu$ V
	Current input		190.7 nA	—	190.7 nA	115.5 nA	500.0 nA
Overall accuracy		$\pm$ 0.3% (0–55 °C), $\pm$ 0.1% (20–30 °C)	$\pm$ 0.3% (0–55 °C), $\pm$ 0.1% (20–30 °C)	$\pm$ 0.3% (0–55 °C), $\pm$ 0.1% (20–30 °C)	$\pm$ 0.1%	$\pm$ 0.1%	$\pm$ 0.2% (0–55 °C), $\pm$ 0.1% (20–30 °C)
Temperature coefficient		—	—	—	$\pm$ 35 ppm/°C (0.0035%/°C)	$\pm$ 35 ppm/°C (0.0035%/°C)	—
Max. conversion time		80 $\mu$ s/channel	80 $\mu$ s/channel	80 $\mu$ s/channel	10 ms/channel	10 ms/channel	5 $\mu$ s/4 channels
Insulation method		Photocoupler insulation between I/O terminals and PLC power supply; no insulation between analog input channels			Transformer insulation between I/O terminals and PLC power supply and between analog input channels		Photocoupler insulation between I/O terminals and PLC power supply; no insulation between analog input channels
Occupied I/O points		16	16	16	16	16	16
Connection terminal		18-point removable terminal block with screws	18-point removable terminal block with screws	18-point removable terminal block with screws	40-pin connector	40-pin connector	18-point removable terminal block with screws
Applicable wire size	mm <sup>2</sup>	0.3–0.75	0.3–0.75	0.3–0.75	0.088–0.3 (A6CON1/4) 0.088–0.24 (A6CON2)	0.088–0.3 (A6CON1/4) 0.088–0.24 (A6CON2)	0.3–0.75
Internal power consumption (5V DC)	mA	220	220	220	330	520	730
Weight	kg	0.12	0.12	0.12	0.19	0.26	0.20
Dimensions (WxHxD)	mm	27.8x106x131	27.8x106x131	27.8x106x131	27.8x106x110	56x106x110	27.8x106x131
<b>Order information</b>	Art. no.	279556	279558	279561	285502	285501	308708

\*High-speed analog input module

■ Analog output modules

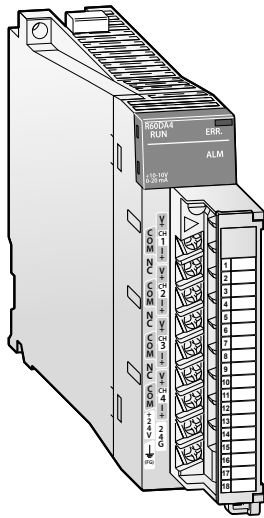

MELSEC iQ-R series analog output modules reliably deliver accurate analog values. A variety of modules (voltage, current, or mixed) are available to cover a wide range of application requirements, such as frequency inverters, valves or slide valves.

**Faster, smoother predefined wave signal output**

The analog output module enables pre-registration of waveforms easily using MELSOFT GX Works3, realizing a smoother continuous output that closely matches the precision required for the application, such as torque control for a press or injection molding machine. Registering the waveform in the module is simple and easy, and does not require a dedicated analog output program, such as for continuous line control, further reducing programming time.

**Special features:**

- Up to 16 channels per module
- Shift operation and scaling can be used without creating programs; they can be simply set on parameters. This simple setting minimizes program development cost as well as the program size.

Specifications	R60DA4	R60DAH4	R60DAV8	R60DAI8	R60DA8-G	R60DA16-G
Output points	4	4	8	8	8	16
Digital input	16-bit, signed binary	16-bit, signed binary	16-bit, signed binary	16-bit, signed binary	16-bit, signed binary	16-bit, signed binary
Analog output	Voltage V DC	-10-10	-10-10	—	-12-12	-12-12
	Current mA DC	0-20	0-20	—	0-20	0-20
Load resistance	Voltage	1 kΩ-500 Ω	min. 1 kΩ	1 kΩ-500 Ω	—	min. 1 kΩ
	Current	0-600 Ω	0-600 Ω	—	0-600 Ω	0-600 Ω
Digital input value	Voltage output	-32000-32000	-32000-32000	-32000-32000	—	-32000-32000
	Current output	0-32000	0-32000	—	0-32000	0-32000
Max. resolution	Voltage output μV	125 μV	—	125 μV	—	125 μV
	Current output nA	350.9 nA	—	—	—	360.1 nA
Overall accuracy	± 0.3 % (0-55 °C), ± 0.1 % (20-30 °C)	± 0.3 % (0-55 °C), ± 0.1 % (20-30 °C)	± 0.3 % (0-55 °C), ± 0.1 % (20-30 °C)	± 0.3 % (0-55 °C), ± 0.1 % (20-30 °C)	± 0.1 %	± 0.1 %
Conversion speed	80 μs/channel	80 μs/channel	80 μs/channel	80 μs/channel	1 ms/channel	1 ms/channel
Insulation method	Photocoupler insulation between I/O terminals and PLC power supply; no insulation between analog output channels; transformer between external power supply and output channels.				Transformer insulation between I/O terminals and PLC power supply, between analog output channels and between external power supply and output channels.	
Occupied I/O points	16	16	16	16	16	48
Connection terminal	18-point removable terminal block with screws	18-point removable terminal block with screws	18-point removable terminal block with screws	18-point removable terminal block with screws	40-pin connector	40-pin connector
Applicable wire size mm <sup>2</sup>	0.3-0.75	0.3-0.75	0.3-0.75	0.3-0.75	0.088-0.3 (A6CON1/4) 0.088-0.24 (A6CON2)	0.088-0.3 (A6CON1/4) 0.088-0.24 (A6CON2)
External power consumption	24 V DC, +20 %, -15 %, 0.14 A	24 V DC, +20 %, -15 %, 0.14 A	24 V DC, +20 %, -15 %, 0.16 A	24 V DC, +20 %, -15 %, 0.26 A	24 V DC, +20 %, -15 %, 0.36 A	24 V DC, +20 %, -15 %, 0.70 A
Internal power consumption 5 V DC mA	160	160	160	160	180	250
Weight kg	0.14	0.14	0.14	0.14	0.21	0.32
Dimensions (WxHxD) mm	27.8x106x131	27.8x106x131	27.8x106x131	27.8x106x131	27.8x106x110	56x106x110
<b>Order information</b>	Art. no. 279557	307260	279560	279559	285504	285503

## ■ Analog modules for temperature measurement

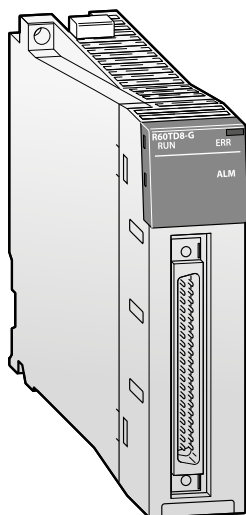

Temperature sensors are connected directly to these modules. They convert measured analog values into 16-bit signed binary temperature measurement values.

### Special features:

- Scaling operations without programs
- Averaging processing
- Disconnection detection function
- Alarm output function
- Logging function
- Issue of an interrupt in case of alarm output or disconnection
- Error history and event history function

Specifications	R60RD8-G	R60TD8-G
Input channels	8	8
Connectable thermocouple type	Pt100, JPt100, Ni100, Pt50	B, R, S, K, E, J, T, N
Temperature measuring range	Depends on the temperature sensor used	
Temperature scaling value	16-bit, signed binary: -2000–8500	16-bit, signed binary: -2700–18200
Max. resolution	0.1 °C	B, R, S, N: 0.3 °C; K, E, J, T: 0.1 °C
Cold junction temp. compensation accuracy	—	±1.0 °C
Overall accuracy	Depends on the thermocouple used	
Max. conversion time	10 ms/channel	30 ms/channel
Analog inputs	8 channels	8 channels + cold junction compensation
Temp. measurement output current	mA	max. 1
Insulation method	Transformer insulation between RTD inputs and PLC power supply, and between RTD input channels	Transformer insulation between thermocouple inputs and PLC power supply, and between thermocouple input channels
Disconnection detection	Built-in	Built-in
Occupied I/O points	16	16
Connection terminal	40-pin connector	40-pin connector
Applicable wire size	mm <sup>2</sup> 0.088–0.3 (A6CON1/4) 0.088–0.24 (A6CON2)	0.088–0.3 (A6CON1/4) 0.088–0.24 (A6CON2)
Internal power consumption (5 V DC)	mA	360
Weight	kg	0.19
Dimensions (WxHxD)	mm	27.8x106x110
<b>Order information</b>	Art. no.	285505
		285506

■ Temperature control modules

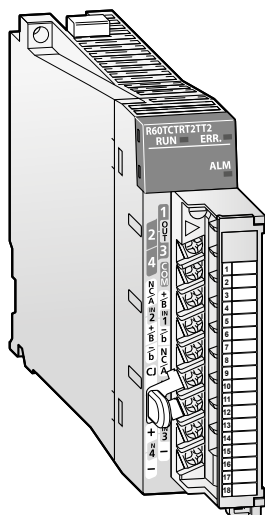

MELSEC iQ-R Series temperature control modules are ideal for applications requiring highly stable and responsive temperature control. The series comes with thermocouple and RTD input module types and are available with or without heater disconnection detection.

**Special features:**

- Selection of various control modes possible
- Easy parameter setting with GX Works3
- Auto-tuning function for setting of suitable PID constants.
- Sensor correction function
- Scaling function
- Heater disconnection detection function
- Unused channels can be used for temperature measurement
- Inter-module link function
- Q compatible mode allows to use existing programs for a MELSEC series Q module
- Error history and event history function

Specifications	R60TCRT2T2	R60TCRT4	R60TCRT2T2BW	R60TCRT4BW	
Control output type	Transistor	Transistor	Transistor	Transistor	
Inputs	4 channels	4 channels	4 channels	4 channels	
Supported temperature sensors	R, K, J, T, S, B, E, N, U, L, PLII, WSRe/W26Re	Pt100, JPt100	R, K, J, T, S, B, E, N, U, L, PLII, WSRe/W26Re	Pt100, JPt100	
Sampling cycle	Switchable between 250 ms and 500 ms/4 channels				
Control output cycle s	0.5–100	0.5–100	0.5–100	0.5–100	
Input filter	1–100 s (0 s: input filter OFF)	1–100 s (0 s: input filter OFF)	1–100 s (0 s: input filter OFF)	1–100 s (0 s: input filter OFF)	
Temperature control method	PID ON/OFF impulse or 2-position control				
PID constant range	PID constant setting	Setting with automatic tuning possible			
	Proportional band P	0.0–1000 % (0 %: 2-position control)	0.0–1000 % (0 %: 2-position control)	0.0–1000 % (0 %: 2-position control)	
	Integral time I	0–3600 s (0 setting for P/PD control)	0–3600 s (0 setting for P/PD control)	0–3600 s (0 setting for P/PD control)	
	Differential time D	0–3600 s (0 setting for P/PI control)	0–3600 s (0 setting for P/PI control)	0–3600 s (0 setting for P/PI control)	
Target value setting range	Within the temperature range of the thermocouple/platinum resistance thermomete used				
Dead band setting range	0.1–10.0 %	0.1–10.0 %	0.1–10.0 %	0.1–10.0 %	
Transistor output	Output signal (sink)	ON/OFF pulse	ON/OFF pulse	ON/OFF pulse	
	Rated load voltage	10–30 V DC	10–30 V DC	10–30 V DC	
	Max. load current	0.1 A/1 point, 0.4 A/common	0.1 A/1 point, 0.4 A/common	0.1 A/1 point, 0.4 A/common	0.1 A/1 point, 0.4 A/common
	Max. rush current	400 mA, 10 ms	400 mA, 10 ms	400 mA, 10 ms	400 mA, 10 ms
	Max. voltage drop when ON	0.1 V DC (TYP) 0.1 A 2.5 V DC (MAX) 0.1 A	0.1 V DC (TYP) 0.1 A 2.5 V DC (MAX) 0.1 A	0.1 V DC (TYP) 0.1 A 2.5 V DC (MAX) 0.1 A	0.1 V DC (TYP) 0.1 A 2.5 V DC (MAX) 0.1 A
	Response time	OFF → ON: <2 ms ON → OFF: <2 ms	OFF → ON: <2 ms ON → OFF: <2 ms	OFF → ON: <2 ms ON → OFF: <2 ms	OFF → ON: <2 ms ON → OFF: <2 ms
Insulation method	Transformer insulation between input terminals and PLC power supply, and between input channels				
Occupied I/O points	16	16	32	32	
Connection terminal	18-point removable terminal block with screws	18-point removable terminal block with screws	Two 18-point removable terminal blocks with screws	Two 18-point removable terminal blocks with screws	
Applicable wire size mm <sup>2</sup>	0.3–0.75	0.3–0.75	0.3–0.75	0.3–0.75	
Internal power consumption (5 V DC) mA	280	280	310	310	
Weight kg	0.22	0.22	0.34	0.34	
Dimensions (WxHxD) mm	27.8x106x110	27.8x106x110	56x106x110	56x106x110	
<b>Order information</b>	Art. no. 290202	290203	290204	290225	

## High-speed counter modules

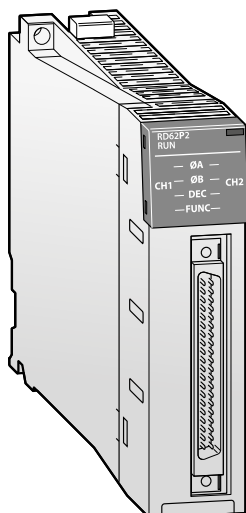

The MELSEC iQ-R series counter modules are capable of 200 k pulse/s for the DC input type, and 8 M pulse/s for differential input. When used with a high-accuracy incremental encoder, positional tracking can also be realized. The pulse measurement feature enables measuring of the pulse cycle.

### Special features:

- Pulse code or pulse measurement
- High-speed PWM output up to 200 kHz with a minimum 100 ns pulse width

Specifications		RD62P2	RD62P2E	RD62D2
Counter inputs		2	2	2
Count input signal	phase	1-phase-input (multiple of 1 or 2), CW/CCW input, 2-phase input (multiple of 1, 2 or 4)		
	signal levels	5/12/24 V DC (2–5 mA)	5/12/24 V DC (2–5 mA)	EIA Standard RS422-A Differential line driver level
Max. counting frequency	kHz	200	200	200
Max. counting speed		200 kHz	200 kHz	8 MHz
Counting range		32-bit, signed binary, -2147483648–2147483647	32-bit, signed binary, -2147483648–2147483647	32-bit, signed binary, -2147483648–2147483647
Counter type		Transistor (sink) output	Transistor (source) output	Transistor (sink) output
Comparison range		32-bit, signed binary	32-bit, signed binary	32-bit, signed binary
External digital input points		Preset, function start	Preset, function start	Preset, function start
	Nominal values	5/12/24 V DC (7–10 mA)	5/12/24 V DC (7–10 mA)	5/12/24 V DC (7–10 mA) (RS422A)
External digital output points (coincidence signal)		2 points/channel 12/24 V DC 0.5 A/point, 2 A/common (sink)	2 points/channel 12/24 V DC 0.1 A/point, 0.4 A/common (source)	2 points/channel 12/24 V DC 0.5 A/point, 2 A/common (sink)
Occupied I/O points		16	16	16
Connection terminal		40-pin connector	40-pin connector	40-pin connector
Applicable wire size	mm <sup>2</sup>	0.088–0.3 (A6CON1/4) 0.088–0.24 (A6CON2)	0.088–0.3 (A6CON1/4) 0.088–0.24 (A6CON2)	0.088–0.3 (A6CON1/4) 0.088–0.24 (A6CON2)
Internal power consumption (5 V DC)	mA	110	200	170
Weight	kg	0.11	0.12	0.12
Dimensions (WxHxD)	mm	27.8x106x110	27.8x106x110	27.8x106x110
<b>Order information</b>	Art. no.	279566	279568	279567
<b>Accessories</b>		40-pin connector and ready to use connection cables > refer to chapter 5		

■ Positioning modules

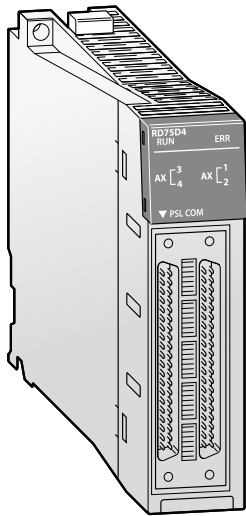

The MELSEC iQ-R series offers a choice of two positioning modules, transistor output or differential drive output, depending on the connected amplifier. The modules are capable of transmission speeds up to 5 M pulses/s, and the differential driver output module supports wiring up to a distance of 10 m. It can be used in positional control or speed control, and features include linear, circular, and helical interpolation, which is a complex control required for deep-thread milling applications.

**Special features:**

- Various positional control
- Multiple startup options
- Helical interpolation

Specifications		RD75D2	RD75D4	RD75P2	RD75P4
Number of control axes		2	4	2	4
Interpolation	pulse/s	2-axis linear interpolation, 2-axis circular interpolation	2-/3-/4-axis linear interpolation, 2-axis circular interpolation, 3-axis helical interpolation	2-axis linear interpolation, 2-axis circular interpolation	2-/3-/4-axis linear interpolation, 2-axis circular interpolation, 3-axis helical interpolation
Positioning	Data items	600	600	600	600
	Method	PTP control: absolute data and/or incremental; speed-position switching control: absolute data and/or incremental; position-speed switching control: incremental path control: absolute data and/or incremental			
	Control range	Absolute data: -2 147 483 648 – 2 147 483 647 pulse -21 474 836 48 – 21 474 836 47 μm -21 474.83648 – 21 474.83647 inch 0 – 359.99999 degree  Incremental method: -2 147 483 648 – 2 147 483 647 pulse -21 474 836 48 – 21 474 836 47 μm -21 474.83648 – 21 474.83647 inch -21 474.83648 – 21 474.83647 degree  Speed/position switching control: 0 – 2 147 483 647 pulse 0 – 21 474 836 47 μm 0 – 21 474.83647 inch 0 – 21 474.83647 degree <sup>①</sup>			
	Speed	1 – 5 000 000 pulse/s 0.01 – 20 000 000.00 mm/min 0.001 – 300 000.000 degree/min 0.001 – 200 000.000 inch/min			
	Acceleration/deceleration processing	Trapezoidal acceleration/deceleration, S-curve acceleration/deceleration			
	Acceleration and deceleration time	ms 1–8388608 (4 patterns each can be set)			
Start time	0.3–1.8 ms (depends on type of control); 8–20 μs with quick start function				
Max. output pulse	kpps	200	5000	200	5000
Output type		Differential driver	Differential driver	Open collector	Open collector
Output signal		Pulse chain	Pulse chain	Pulse chain	Pulse chain
External connection		40-pin connector	40-pin connector	40-pin connector	40-pin connector
Applicable wire size	mm <sup>2</sup>	0.088–0.3 (A6CON1/4) 0.088–0.24 (A6CON2)	0.088–0.3 (A6CON1/4) 0.088–0.24 (A6CON2)	0.088–0.3 (A6CON1/4) 0.088–0.24 (A6CON2)	0.088–0.3 (A6CON1/4) 0.088–0.24 (A6CON2)
Internal power consumption (5 V DC)	A	0.38	0.54	0.42	0.78
Occupied I/O points		32	32	32	32
Weight	kg	0.14	0.15	0.15	0.15
Dimensions (WxHxD)	mm	27.8x106x110	27.8x106x110	27.8x106x110	27.8x106x110
<b>Order information</b>	Art. no.	279564	279565	279562	279563
<b>Accessories</b>		40-pin connector and ready to use connection cables > refer to chapter 5			

① Speed-position switching control (ABS mode): 0–359.99999 degree. The ABS mode can be used only when the control unit is degree.



## Simple Motion modules

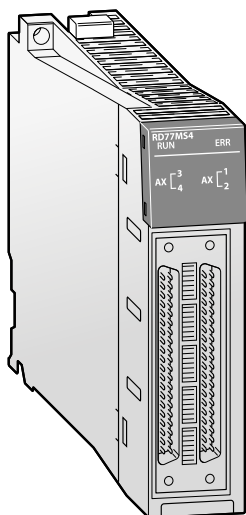

The MELSEC iQ-R series lineup includes Simple Motion modules in addition to the regular positioning modules. Various control functions previously only possible with Motion Controllers, such as speed control, torque control, synchronous control and cam control, are now available with the Simple Motion modules.

These functions can be realized with simple parameter adjustments and via the PLC program.

### Special features:

- Various position control modes
- Home position return control
- Advanced synchronous control
- Mark detection
- Speed-torque control (press-fit control)
- Manual control (JOG, inching, or manual pulse generator operation)
- Connection to CC-Link IE Field reduces wiring for RD77GF

Specifications	RD77GF4	RD77GF8	RD77GF16	RD77GF32	RD77MS2	RD77MS4	RD77MS8	RD77MS16
Number of controllable axes	4	8	16	32	2	4	8	16
Interpolation functions	Linear interpolation for up to 4 axes, circular interpolation for 2 axes, helical interpolation for 3 axes				2 axes linear and circular interpolation	Linear interpolation for up to 4 axes, circular interpolation for 2 axes		
Servo amplifier network	CC-Link IE Field	CC-Link IE Field	CC-Link IE Field	CC-Link IE Field	SSCNETIII/H	SSCNETIII/H	SSCNETIII/H	SSCNETIII/H
Servo amplifier	MR-J4-GF(-RJ)				MR-JE-B/MR-J4(W2/W3)-B over SSCNETIII/H			
Operation cycle	ms 0.5, 1.0, 2.0, 4.0			0.5, 1.0, 2.0, 4.0	0.444, 0.888, 1.777, 3.555			
Positioning	Method PTP (Point To Point) control, path control (linear and arc), speed control, speed-position switching control, position-speed switching control, speed-torque control, advanced synchronous control							
	Acceleration/deceleration control Trapezoidal acceleration/deceleration, S-curve acceleration/deceleration							
	Compensation Backlash compensation, electronic gear, near pass function							
Number of positioning points	600 data/axis (All the data points can be set with the buffer memory.)				600 per axis (can be set with GX Works3 or PLC program)			
External input signals	External devices, like encoder or remote I/O are connected via CC-Link IE Field				1 encoder, A/B phase; 4 digital inputs [DI1–DI4]			
Cam function	Storage area cam data 3 MBytes, max. 1024 (depends on resolution)				256 kBytes, max. 256 (depends on resolution)			
Occupied I/O points	32	32	32	64	32	32	32	32
Connection terminal	RJ45 connector	RJ45 connector	RJ45 connector	RJ45 connector	40-pin connector	40-pin connector	40-pin connector	40-pin connector
Applicable wire size	mm <sup>2</sup> 0.088–0.3 (A6CON1/4) 0.088–0.24 (A6CON2)	0.088–0.3 (A6CON1/4) 0.088–0.24 (A6CON2)	0.088–0.3 (A6CON1/4) 0.088–0.24 (A6CON2)	0.088–0.3 (A6CON1/4) 0.088–0.24 (A6CON2)	0.088–0.3 (A6CON1/4) 0.088–0.24 (A6CON2)	0.088–0.3 (A6CON1/4) 0.088–0.24 (A6CON2)	0.088–0.3 (A6CON1/4) 0.088–0.24 (A6CON2)	0.088–0.3 (A6CON1/4) 0.088–0.24 (A6CON2)
No. of Simple Motion modules in one system	8	8	8	8	8	8	8	8
Internal power consumption (5V DC)	A 1.1	1.1	1.1	1.1	1.0	1.0	1.0	1.0
Weight	kg 0.23	0.23	0.23	0.23	0.22	0.23	0.23	0.23
Dimensions (WxHxD)	mm 27.8x106x110	27.8x106x110	27.8x106x110	27.8x106x110	27.8x106x110	27.8x106x110	27.8x106x110	27.8x106x110
Order information	Art. no. 295077	295078	295079	304200	280229	280230	280231	280232

■ Interface modules

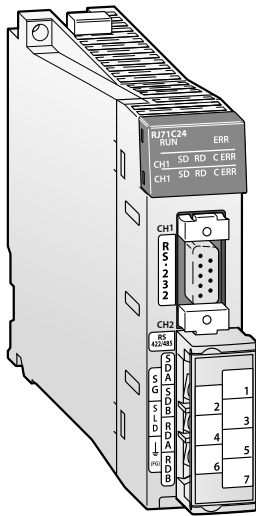

The serial communication modules enable serial devices with up to 230.4 kbps transmission speeds to be connected per channel. Communications protocols such as Modbus® are supported via the pre-defined protocol feature.

**Special features:**

- Various communication modes (MC protocol, predefined protocol, nonprocedural protocol)
- Debug support function

Specifications		RJ71C24	RJ71C24-R2	RJ71C24-R4
Interface type	channel 1	RS232-compliance (D-Sub 9P female)	RS232-compliance (D-Sub 9P female)	RS422/485-compliance (2-piece terminal block)
	channel 2	RS422/485-compliance (2-piece terminal block)	RS232-compliance (D-Sub 9P female)	RS422/485-compliance (2-piece terminal block)
Communications mode		Full-duplex/half-duplex	Full-duplex/half-duplex	Full-duplex/half-duplex
Synchronisation		Start-stop	Start-stop	Start-stop
Data transfer	Rate	bps	1200/2400/4800/9600/14400/19200/28800/38400/57600/115200/230400	
	Distance RS232	m	Max. 15	—
	Distance RS422/485	m	Max. 1200 (if both channels are used)	—
Network configuration		RS232: 1:1 RS422/485: 1:1; 1:n; n:1; m:n	RS232: 1:1	RS422/485: 1:1; 1:n; n:1; m:n
Data format		1 start bit, 7 or 8 data bits, 1 or 0 parity bits, 1 or 2 stop bits	1 start bit, 7 or 8 data bits, 1 or 0 parity bits, 1 or 2 stop bits	1 start bit, 7 or 8 data bits, 1 or 0 parity bits, 1 or 2 stop bits
Error detection		Parity check, sum check, horizontal parity, 16-bit CRC (for MODBUS)		
DTR/DSR control		For RS232	Available	—
X ON/X OFF (DC1/DC3)		Available	Available	Available
Occupied I/O points		32	32	32
Internal power consumption (5 V DC)		mA	310	200
Weight		kg	0.16	0.14
Dimensions (WxHxD)		mm	27.8x106x110	27.8x106x110
<b>Order information</b>		Art. no.	279573	279574
				279575

## Network modules

The network and interface modules of the MELSEC iQ-R series ensure a vast selection of interconnectivity possibilities with various protocols and network topologies providing the best-fit solution for various applications. At the core of the Series is the CC-Link IE network family which is a high-speed 1 Gbps control level and field level Ethernet topology industrial open network.

### Seamless message protocol (SLMP\*) network communications

With SLMP, it is possible to seamlessly access production management systems, programmable controllers and other devices using the same method, eliminating concerns about network hierarchies and boundaries. Tasks such as machine monitoring, data collection and maintenance can be performed from virtually anywhere on the network. Used together with the Ethernet module, SLMP-ready Ethernet devices such as a machine vision sensor or RFID controller can be interfaced to the CC-Link IE Field Network without further adding another network.

\* SLMP (Seamless Message Protocol): Is a client/server protocol that enables communications between Ethernet-ready and CC-Link IE compatible devices.

### Special features:

- 1 Gbps high-speed, large bandwidth of 128 k word for CC-Link IE
- Connect to two separate networks using a single module
- Seamless networking (SLMP)
- Loop-back function
- Auto-return when faulty station is replaced
- Supports standard interfaces such as RS232 and RS422/485

### Ethernet module

Module	Specifications	Art. no.
RJ71EN71	1 Gbps, 100/10 Mbps, multiple network, Ethernet cable (Category 5e or higher, double shielded/STP)	279570

### CC-Link IE control module

Module	Specifications	Art. no.
RJ71GP21-SX	1 Gbps, control/normal station, fiber optic cable, dual loop, which satisfies 1000 BASE-SX standard: multi-mode optical fiber (GI)	279571

### CC-Link IE Field module

Module	Specifications	Art. no.
RJ71GF11-T2	1 Gbps, master/slave module, Ethernet cable (Category 5e or higher, double shielded/STP)	279569

### CC-Link IE Field remote head module

Module	Specifications	Art. no.
RJ72GF15-T2	1 Gbps, remote station, Ethernet cable (Category 5e or higher, double shielded/STP)	297947

### AnyWireASLINK master module

Module	Specifications	Art. no.
RJ51AW12AL	Sensor-level network	301856

### CC-Link module

Module	Specifications	Art. no.
RJ61BT11	Max. 10 Mbps, master/local station (CC-Link Ver.2)	297346

### Profinet module

Module	Specifications	Art. no.
RJ71PN92*	Profinet master module	308713

### Profibus DP module

Module	Specifications	Art. no.
RJ71PB91V*	Profibus master/slave module	308714

### CANopen module

Module	Specifications	Art. no.
RJ71CN91*	CANopen communication module	308735

■ MES Interface module

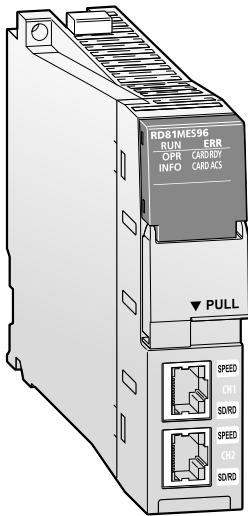

Along with ever-changing manufacturing trends, improving machine productivity and maintaining manufacturing quality through meticulous traceability have become a fundamental part of manufacturing. MES Interface modules address these requirements by providing direct database connectivity for IT systems and facilitating automatic SQL\* text generation using intuitive configuration setup software. Modules allow production data from the shop floor to be inserted into database records directly; for example, providing real-time production status that enables quicker response to production-related problems.

\* Structured Query Language is a programming language designed for managing data in a relational database.

**Special features:**

- Extensive data handling from shop floor to business process systems
- Direct access to IT system database
- Production data directly inserted into database
- System configuration costs reduced by 65 % (Assumption based on a typical control architecture.)

Specifications		RD81MES96
Module type		MES Interface module
Transmission method		Ethernet
Interface	type	1000BASE-T/100BASE-TX/10BASE-T (2CH)
Database connection	Supported database	Oracle® Database, Microsoft® SQL Server, Microsoft® Access
	SQL text transmission	SELECT, INSERT, UPDATE, DELETE, Multi-SELECT, STORED PROCEDURE
	Database communication action field	65,536
	Accessible CPU module	iQ-R series (direct, remote), System Q series (remote), L series (remote)
Data sampling interval	High-speed data sampling	ms Sequence scan time synchronization, 1–900
	General data sampling	s 0.1–0.9, 1–3600
Function	DB record read/write	Reads/writes data in the database of the host information system
	Device memory read/write	Reads/writes device memory data of the CPU module
	Trigger condition monitoring	Monitors values of the time or device tag components etc., and starts jobs when a trigger condition changes from false to true (the condition is satisfied)
	Data operation and processing	Performs four arithmetic operations, obtains remainder, performs character string operation, etc.
	Program execution	Executes a program on the server through a MES interface module
	DB buffering	Buffers the data sent to the database, and resend it after recovery, when the data cannot be linked due to the disconnection of the network between MES Interface module and the database or failure of the database etc.
Occupied I/O points		32
Internal power consumption (5 V DC)	mA	1250
Weight	kg	0.25
Dimensions (WxHxD)	mm	27.8x106x110
<b>Order information</b>	Art. no.	295423

## ■ iQ-R C-Application server

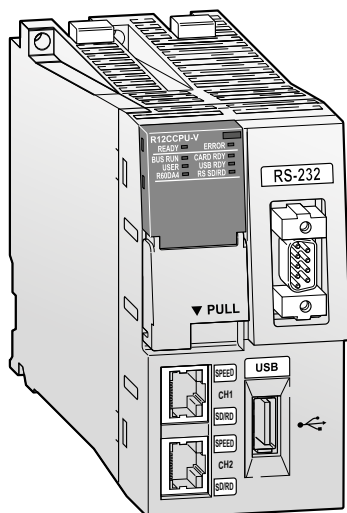

The C-Application server is based on the iQ-R series C-Controller platform and with its robust OS has allowed Mitsubishi Electric to make a giant leap forward into the future of cloud connectivity. The C-Application server is based on modern web services and supports all kind of IoT requests. Its strength is to collect information in real time, provide analysis and forwards the results to a variety of cloud systems.

The C-Application server supports:

- Event handler – Asynchronous bi-direction HTTP(S) protocol
- LUA server pages, including LUA virtual machine
- SSL/TLS client/server including SSL certificate
- Raima database, SQLite, MySQL and Redis connectors
- Web services – JSON-RPC, XML-RPC and SOAP
- HTTP(S) client libraries
- Client and server (secure) TCP socket API
- Mail (SMTP) client

Specifications		C-Application server for R12CCPU-V
Transmission type		Ethernet, Serial
Interface		1000BASE-T, 100BASE-TX, 10BASE-T, RS232
Database		SQLite3, MySQL, Redis
Function		<ul style="list-style-type: none"> <li>● CCPU and MD library function support</li> <li>● CAS specific functions</li> <li>● HTML5</li> <li>● Websocket</li> <li>● Lua API</li> <li>● Lua server pages</li> <li>● XML parser</li> <li>● Event handler</li> <li>● REST, AJAX, SOAP, JSON, XML-RPC Web-Services</li> <li>● WebDAV</li> <li>● SMTP, SMTPS, STARTTLS</li> <li>● SSL, Shark SSL</li> <li>● SMQ</li> <li>● PikeHTTP</li> </ul>
Weight	kg	0.35
Dimensions (WxHxD)	mm	106x56x110
Order information	Art. no.	308736

■ High-speed data logger module

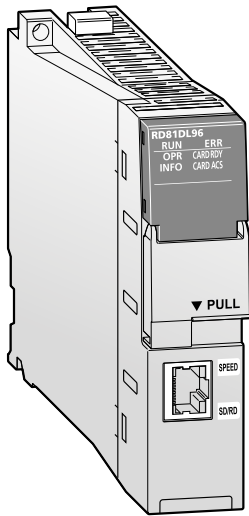

The production process data acquisition feature of this high-speed data logger module contributes to improving production quality and efficiency, thereby realizing optimal production processes. The module enables logging of various data such as Unicode, CSV, and BIN text formats, which can be utilized for spreadsheet reporting owing to the automatic report generation feature: BIN text format data can be ported directly to Microsoft® Windows® Excel®. Logging files can also be automatically sent to a FTP server or directly into a Microsoft® Windows® share folder.

**Special features:**

- Data logging synchronized with control system scan time
- Easier root cause analysis
- Utilize data for various analysis and maintenance processes
- Built-in SD memory slot

Specifications		RD81DL96
Accessible CPU modules		iQ-R series (direct, remote), System Q series (remote), L series (remote)
Data sampling interval	High-speed data sampling	ms <ul style="list-style-type: none"> <li>● Sequence scan time synchronization</li> <li>● 0.5–0.9, 1–32767 (for trigger logging)</li> <li>● 2–32767 (for continuous logging)</li> </ul>
	General data sampling	s <ul style="list-style-type: none"> <li>● 0.1–0.9, 1–32767</li> <li>● Time interval specification (specify hour/minute/second)</li> </ul>
Amount of sampled data	High-speed data sampling	Overall amount of data: 32768 (per setting: 1024) <ul style="list-style-type: none"> <li>● Overall number of device points: 32768 (per setting: 4096)</li> </ul>
	General data sampling	<ul style="list-style-type: none"> <li>● Overall amount of data: 65536 (per setting: 1024)</li> <li>● Overall amount of data: 262144 (per setting: 4096)</li> </ul>
Function	Data logging	Logs CPU module device values at specified data sampling intervals.
	Event logging	Monitors sampled device values from the CPU module, and logs events that occur.
	Report	Outputs the data sampled by the high-speed data logger module as an Excel® file.
	Recipe	Executes the following operations using recipe files stored in the SD memory card: <ul style="list-style-type: none"> <li>● Transfer device values written on the recipe files to devices in the CPU module.</li> <li>● Transfer device values in the CPU module to the recipe files.</li> </ul>
Internal power consumption (5 V DC)		A 1.1
Weight		kg 0.24
Dimensions (WxHxD)		mm 27.8x106x110
<b>Order information</b>		Art. no. 308709

## ■ C intelligent function module

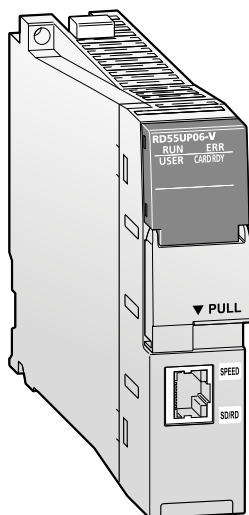

### C/C++ program execution

The C Intelligent function module is available with a multi-core ARM®-based controller pre-installed with VxWorks® Version 6.9, which realizes simultaneous execution of programs, thereby providing a robust and deterministic alternative to computer-based systems. Utilizing a fan-less hardware design, the C Intelligent function module is ideal for clean fab-based environments, where dust circulation can be detrimental to the production environment, and can be used for applications such as in-line production quality testing or as a gateway for various industry-specific communications protocols.

### Special features:

- Realize complex arithmetic equations in C/C++
- Application development in simple steps
- Emulates the same features as a standalone C Controller
- SD memory card slot

Specifications		RD55UP06-V
Hardware	Endian format	Little endian
	MPU	ARM® Cortex-A9 Dual Core
	Working RAM	128 MB
	ROM	12 MB
Software	Operating system	VxWorks Version 6.9
	Programming language	C language (C/C++)
	Programming development environment	CW Workbench/Wind River Workbench3.3
	Setting/monitoring tool	GX Works3 (SW1DND-GXW3-E) ①
Communication interface		Ethernet (1000BASE-T/100BASE-TX/10BASE-T) (1 CH)
Occupied I/O points		32
Clock		Obtained from a programmable controller CPU (in multiple CPU system, CPU No. 1).
Internal power consumption (5 V DC)		A 1.09
Weight		kg 0.24
Dimensions (WxHxD)		mm 27.8x106x110
<b>Order information</b>		Art. no. 303298

① Setting and monitoring of the module is integrated within the GX Works3 engineering software.

Accessories for the iQ-R series from page 114 onward!

■ Base units

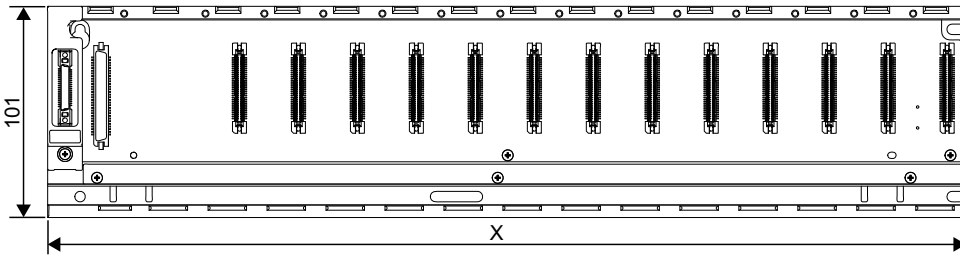

Type	X (in mm)
R35B	245
R38B	328
R38RB-HT	439
R310RB, R310B-HT	439
R312B	439

Unit: mm

■ Extension base units

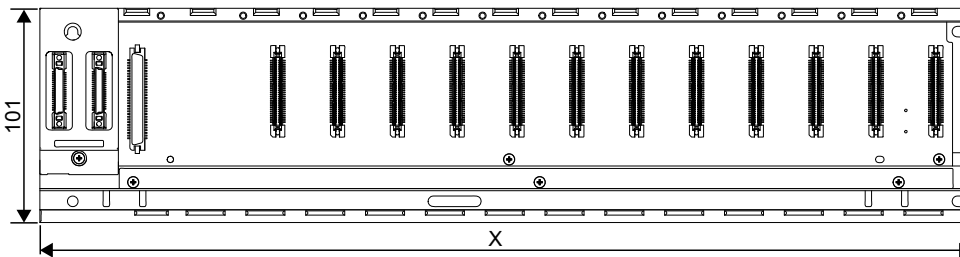

Type	X (in mm)
R65B, RQ65B	245
R68B, RQ68B	328
R68RB-HT	439
R610RB, R610B-HT	439
R612B, RQ612B	439

Unit: mm

■ Power supply

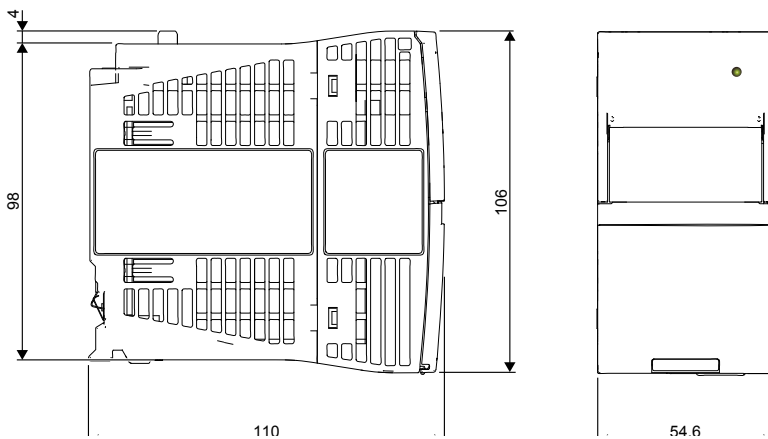

Unit: mm



■ CPU modules

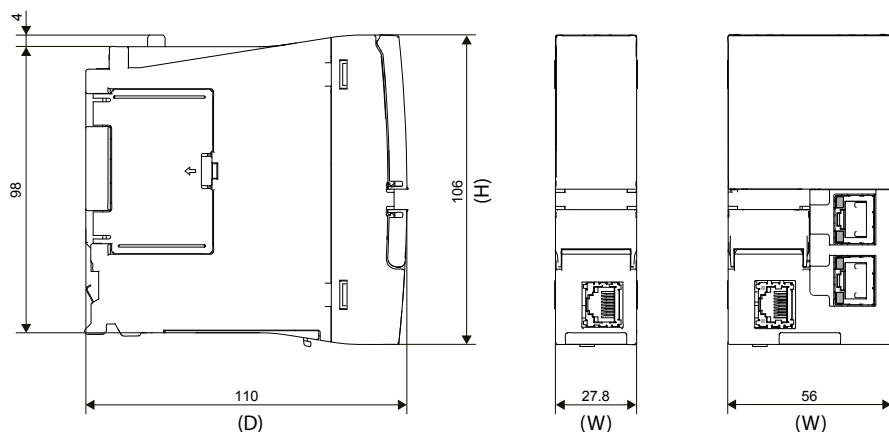

Type	W	H	D
R04CPU R08CPU R16CPU R32CPU R120CPU	27.8	106	110
R04ENCPU R08ENCPU R16ENCPU R32ENCPU R120ENCPU	56	106	110

Unit: mm

2

MELSEC iQ-R series

■ Process CPU modules and redundant function module

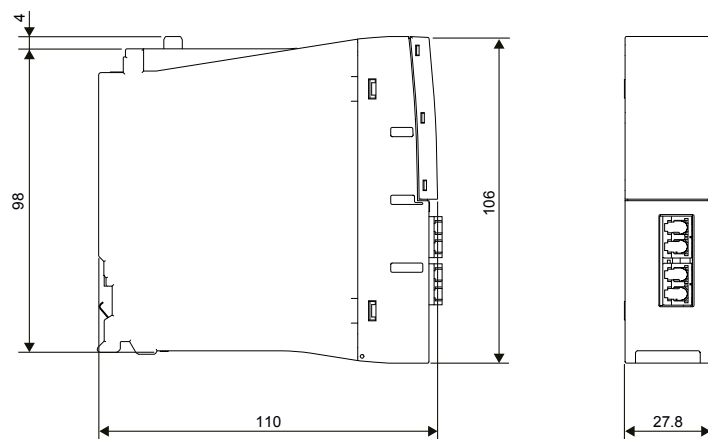

Unit: mm

■ C Controller CPU

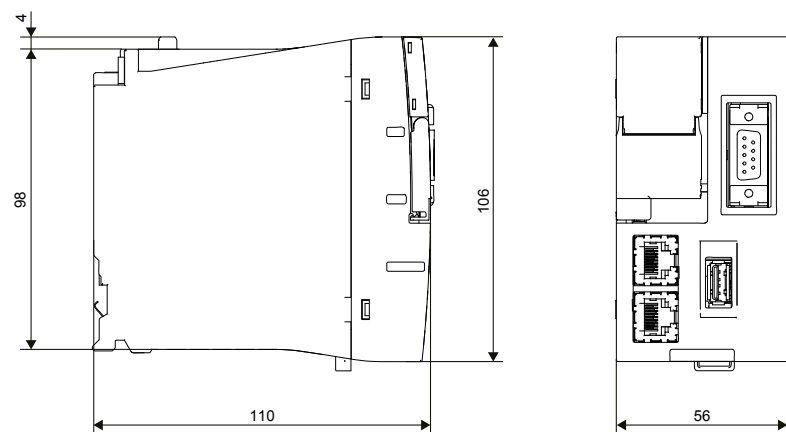

Unit: mm

■ Safety function module and safety CPU

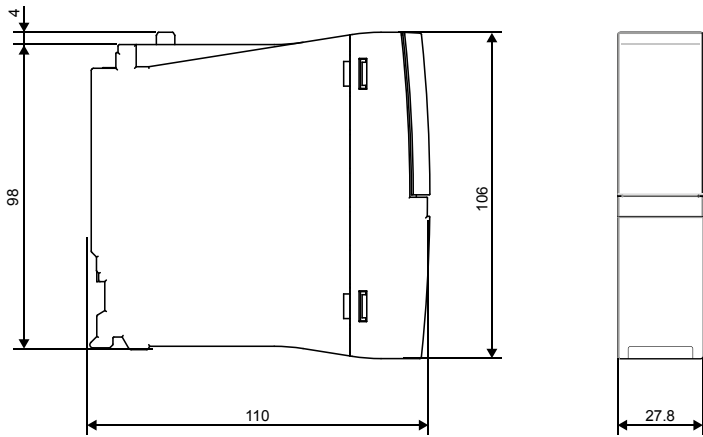

Unit: mm

■ I/O modules, blank cover module special function modules

18-point screw terminal block

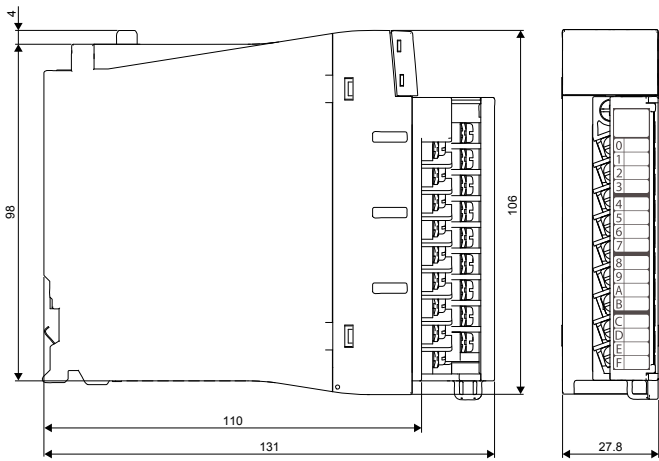

Blank cover module

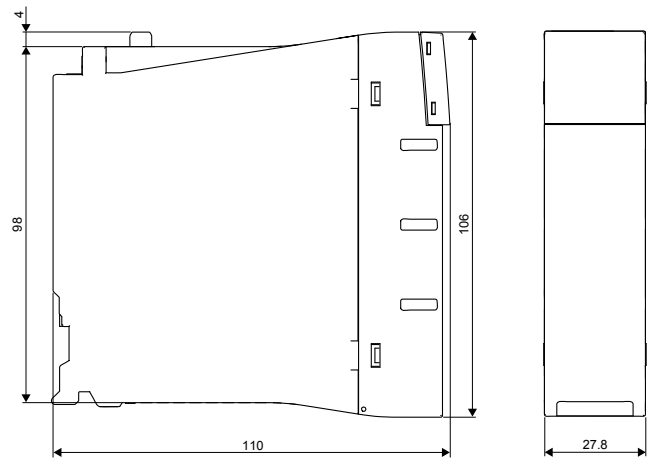

40-pin connector, 32 points module

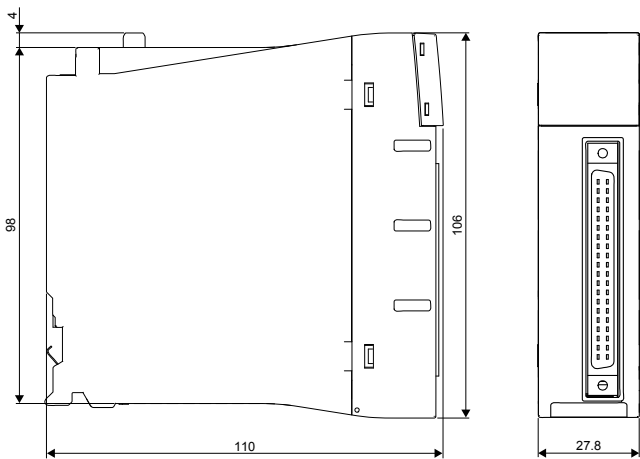

40-pin connector, 64 points module

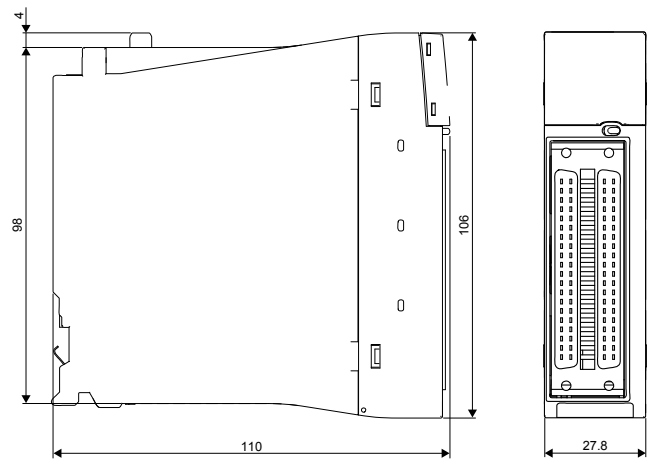

Unit: mm

# MELSEC System Q

## Automation platform

### Description

With the MELSEC System Q, Mitsubishi Electric presents its most powerful and compact modular PLC, with multiprocessor technology for present and future challenges.

The small size, the communications capability and the high-performance multiprocessing are three important characteristics of the MELSEC System Q. Its compactness ensures that it occupies less space in the switchgear cabinet and its diverse communication facilities guarantee flexibility and openness. Depending on the selected CPU type up to 4096 local and up to 8192 remote I/O points can be addressed. This controller is particularly suitable for performing medium- to high-performance automation tasks.

The individual systems can be installed in different MELSEC and open networks (e.g. MELSECNET, CC-Link, Ethernet or Profibus DP/Profinet), enabling them to communicate with one another. The number of I/Os can thus be increased several times.

Thanks to the unique combination possibilities of PLC, process, redundancy, PC/C, robot, CNC and motion CPUs a platform is available that meets every automation task.

### Special features:

- up to 4096 local I/Os
- up to 8192 remote I/Os
- interchangeable intelligence
- multiprocessor technology with 45 different CPU types from 9 families (PLC, process, redundancy, PC/C, motion, CNC and robots)
- wide range of communications facilities
- easy installation
- one system platform for all configurations
- innovative technology for future applications

### Expandability and performance

As with other Mitsubishi Electric controllers the power of the MELSEC System Q grows with your application – you simply replace or add a CPU. When using the multi processor type CPUs the control and communication tasks are shared by up to four CPUs. Every system can provide a maximum capacity of 4,096 local I/Os or 8,192 remote I/Os.

The integrated memory of up to 1000 k program steps (which conforms to 1 MB RAM) can easily be expanded by up to 32 MB memory at any time just by slotting in an extension card.

The MELSEC System Q offers state-of-the-art performance by a wide range of CPU models, for all applications.

### Universal PLC CPUs

CPU type	Program capacity	I/O points
Q00UJCPU	10 k steps	256/8192
Q00UCPU	10 k steps	1024/8192
Q01UCPU	15 k steps	1024/8192
Q02UCPU	20 k steps	2048/8192
Q03UDCPU	30 k steps	4096/8192
Q03UDECPU	30 k steps	4096/8192
Q03UDVCPU	30 k steps	4096/8192
Q04UDHCPU	40 k steps	4096/8192
Q04UDEHCPU	40 k steps	4096/8192
Q04UDVCPU	40 k steps	4096/8192
Q06UDHCPU	60 k steps	4096/8192
Q06UDEHCPU	60 k steps	4096/8192
Q06UDVCPU	60 k steps	4096/8192
Q10UDHCPU	100 k steps	4096/8192
Q10UDEHCPU	100 k steps	4096/8192
Q13UDHCPU	130 k steps	4096/8192
Q13UDEHCPU	130 k steps	4096/8192
Q13UDVCPU	130 k steps	4096/8192
Q20UDHCPU	200 k steps	4096/8192
Q20UDEHCPU	200 k steps	4096/8192
Q26UDHCPU	260 k steps	4096/8192
Q26UDVCPU	260 k steps	4096/8192
Q50UDEHCPU	500 k steps	4096/8192
Q100UDEHCPU	1000 k steps	4096/8192

### Process CPUs

CPU type	Program capacity	I/O points
Q02PHCPU	28 k steps	4096/8192
Q06PHCPU	60 k steps	4096/8192
Q12PHCPU	124 k steps	4096/8192
Q25PHCPU	252 k steps	4096/8192

### Redundant PLC CPUs

CPU type	Program capacity	I/O points
Q12PRHCPU	124 k steps	4096/8192
Q25PRHCPU	252 k steps	4096/8192

### Motion CPUs

CPU type	Program capacity	I/O points; axes
Q172DSCPU	16 k steps	8192; 16
Q173DSCPU	16 k steps	8192; 32

### PC CPU

CPU type	Program capacity	I/O points
Q10WCPU-W1-E/CFE	1 GB	1 Input (shutdown), 2 Outputs (shutdown, watchdog timer)

### Special purpose CPUs (C Controller, Robot)

CPU type	Program capacity	I/O points
Q12DCCPU	128 MB	4096/8192
Q24DHCCPU	382 MB	4096
Q173NC	230 kB (600 m)	4096/8192

### General specifications

General specifications	Data
Ambient operating temperature	0–55 °C
Storage temperature	-25–75 °C
Ambient relative humidity	Max. 95 % (non-condensing)
Protection	IP20
Noise durability	1500 Vpp with noise generator; 1 ms at 25–60 Hz
Insulation withstand voltage	AC 1500 V, 1 min.
Shock resistance	10 g (3 times each in 3 directions)/EN 61131-2
Vibration resistance	2 g: resistant to vibrations from 10–55 Hz for 2 hours along all 3 axes; 0.5 g for DIN rail mounting/EN 61131-2
Insulation resistance	>5 MΩ (500 V DC)
Ground	Class 3
Environment	Avoid environments containing corrosive gases, install in a dust-free location.
Certifications	UL/CSA/CE/DNV/NK/LR/ABS/GL/RINA/BV

## The MELSEC QS safety programmable controller

Even with increasing productivity, the safety of workers operating machinery and manufacturing facilities must still always have top priority. The MELSEC System QS PLC is specially designed for managing safety systems.

It is connected to safety devices like Emergency Stop switches and light curtains and has extensive diagnostics functions that enable it to reliably switch safety-critical outputs at the right time to turn machines off in the event of danger.

The actual machinery (conveyor belts, robots etc.) is still controlled by a conventional PLC. The MELSEC System QS PLC is compliant to the international safety standards EN954-1 Category 4, ISO13849-1 PL e, and IEC61508 (JIS C 0508) SIL 3 and certified by TÜV Rheinland.

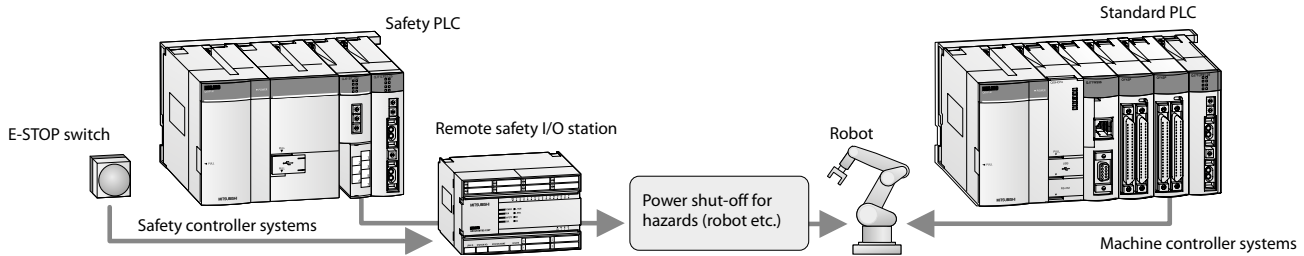

## CC-Link safety

The CC-Link safety network eliminates the complex wiring needed in conventional safety controller systems. The remote safety I/O stations in the safety PLC are connected to the CC-Link master module in the safety PLC using standard CC-Link cables. In the event of communications errors powerful and effective error identification routines automatically switch off the outputs of both the safety PLC and the remote safety I/O stations. CC-Link safety is also compatible with CC-Link. This means you can also use standard CC-Link I/O modules in a CC-Link Safety network for those inputs and outputs that are not critical for safety.

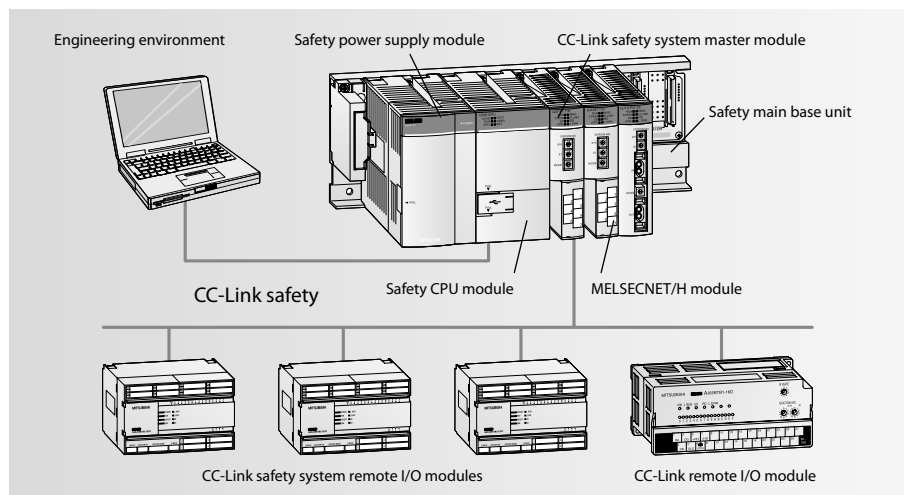

Type	Safety controller components	Art. no.
QS001CPU	Safety PLC, 14 K steps program capacity	203205
QS034B-E	Safety base unit, accommodates power supply unit, CPU and up to 4 modules	203206
QS061P-A1	Safety power supply unit, 100–120 V AC	203207
QS061P-A2	Safety power supply unit, 200–240 V AC	203208
QS0J61BT12	CC-Link safety master module	203209
QS0J65BTB2-12DT	Safety remote I/O module, 8 dual safety inputs + 4 dual safety outputs	203210
QS0J65BTS2-8D	CC-Link safety remote I/O module, 8 dual safety inputs	217625
QS0J65BTS2-4T	CC-Link safety remote I/O module, 4 dual safety outputs	217626
QS0J71GF11-T2	CC-Link safety master module (local module)	245177

## Safety relays

Safety relay modules are the ideal solution for applications where you don't need a separate safety PLC. These modules are installed together with the standard MELSEC System Q components on the same base unit, or in a CC-Link network. This enables a normal PLC used as a controller to also perform safety functions, without the added cost of a separate safety controller and without additional programming and configuration.

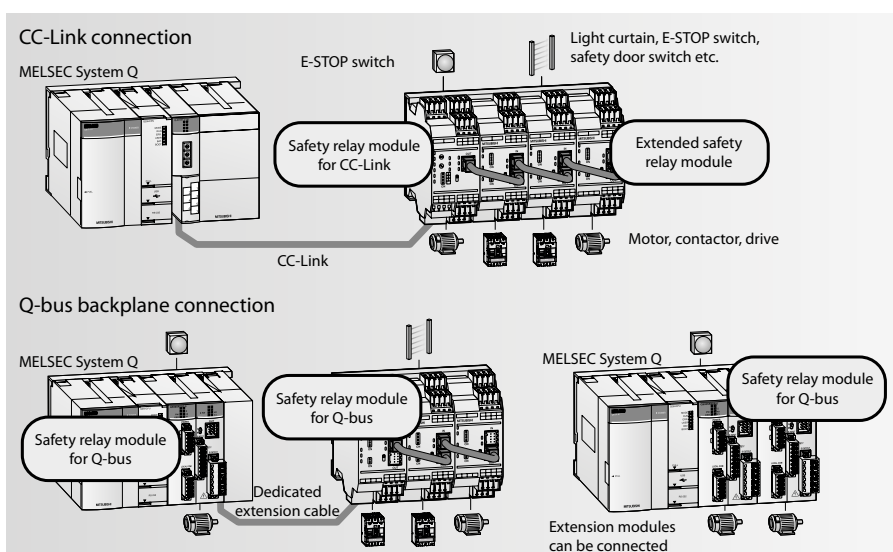

Specifications	Module	Type	Art. no.	
Safety relay modules	For installation in a CC-Link station	QS90SR2SP-CC	P-Type, 1 safety input, 1 safety output	215801
		QS90SR2SN-CC	N-Type, 1 safety input, 1 safety output	215803
	For installation on a MELSEC System Q base unit	QS90SR2SP-Q	P-Type, 1 safety input, 1 safety output	215799
		QS90SR2SN-Q	N-Type, 1 safety input, 1 safety output	215800
Extension modules	Can be connected to safety relay modules	QS90SR2SP-EX	P-Type, 1 safety input, 1 safety output	215804
		QS90SR2SN-EX	N-Type, 1 safety input, 1 safety output	215805

## MELSEC WS safety controller

The MELSEC WS safety controller provides a cost effective way to add a safety controller capability to individual machines, or smaller scale systems. Mitsubishi Electric is proud to announce that the WS is a joint development with SICK AG of Germany, an acknowledged leader in the global machine safety industry. Its compact size insures easy placement in most control cabinets, without adding extra cost. Configuration saves engineering time by using a graphical icon based method, and program development and certification is simplified by the use of safety function blocks. For more complex needs, the WS is also scalable by simply adding additional I/O modules. Finally, integration with conventional control systems is easily achieved with the CC-Link open network connection or Ethernet.

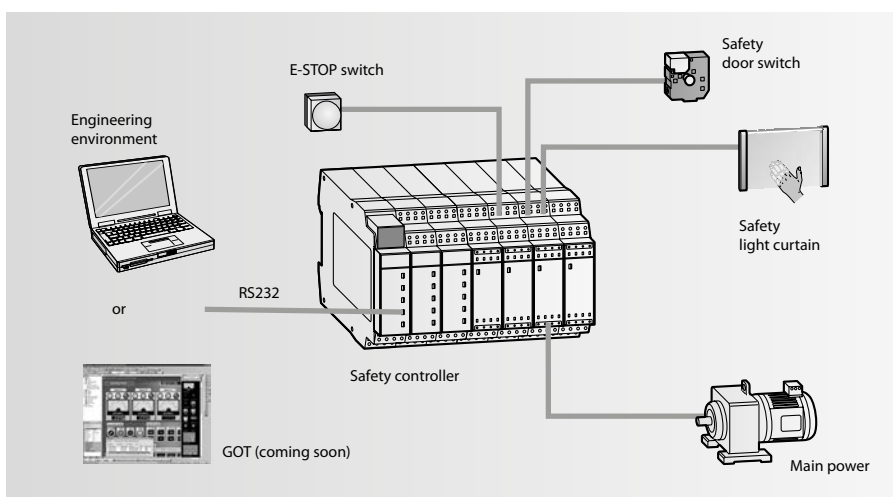

Function	Module	Description	Art. no.
CPU	WS0-CPU000200	Program memory: 255 function blocks	230057
	WS0-CPU130202	Program memory: 255 function blocks; EFI (direct communication with SICK safety devices)	230058
Input module	WS0-XTD180202	8 safety inputs	230059
Input/output modul	WS0-XTI084202	8 safety inputs; 4 safety outputs	230060
Output module	WS0-4R04002	4 safety relay outputs	230064
Communication module	WS0-GETH00200	Module for Ethernet communication	230063
	WS0-GCC100202	Module for CC-Link communication	235441
Memory	WS0-MPL000201	Memory plug	230061
Programming cable	WS0-C20R2	Serial programming cable	230062

## Configuration

### System structure

The CPU and modules are held in a base unit which has an internal bus connection for communication between the individual modules and the CPUs. The power for the modules inserted in the base unit is delivered by the power supply module.

The base units are available in 4 different versions with 3 to 12 module slots. Each base unit can be supplemented by means of an extension unit providing additional slots.

If you wish to keep open the option of subsequent extension of your PLC or if you have free slots on your base unit, you can insert dummy modules here. They serve to protect the free slots from soiling or from mechanical effects but can also be used for reserving I/O points.

For cabling larger systems and machines - e.g. in a modular design - the use of remote I/O modules offers additional communications facilities.

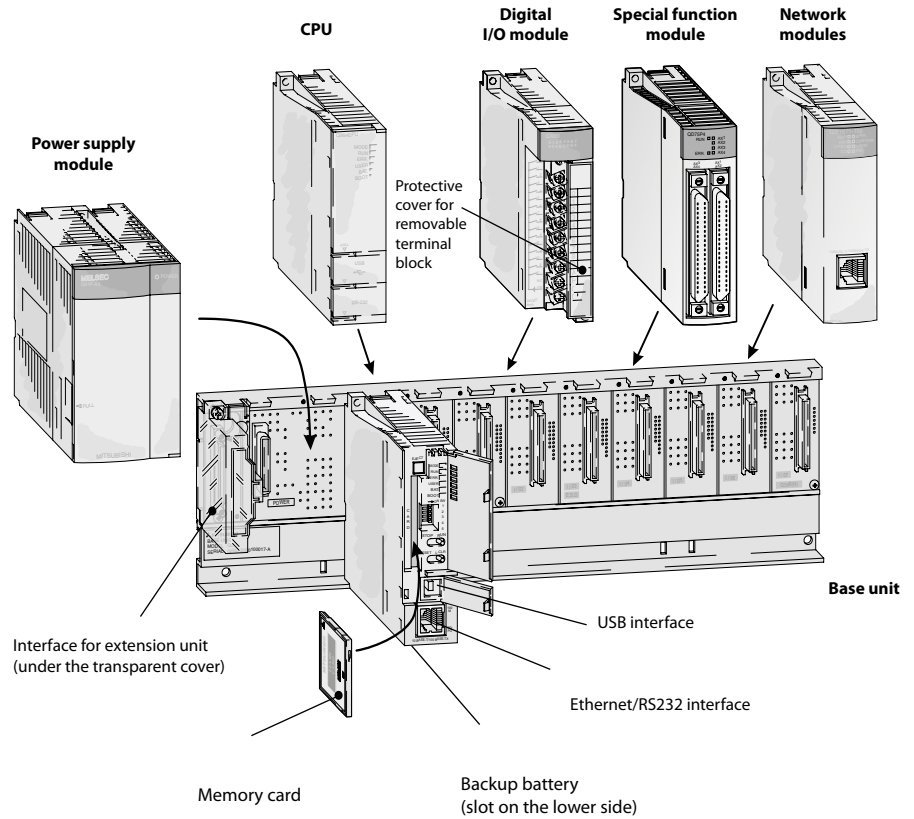

### Extension

The base unit and extension units are simply connected to one another by extension cables. When the Q52B and Q55B are used these cables also supply the necessary 5V DC power supply to the extension base unit.

Up to seven extension units with up to 64 modules can be connected to base units or extension base units. The extension may be in the horizontal or vertical direction and allows a maximum distance of the extensions cables of 13.2 m.

When choosing the power supply module, the total power consumption of the I/O modules, of the special function modules and of the peripherals must be taken into account. If necessary, an extension unit with a further power supply module should be used.

It is also possible to use a redundant power supply configuration to increase availability.

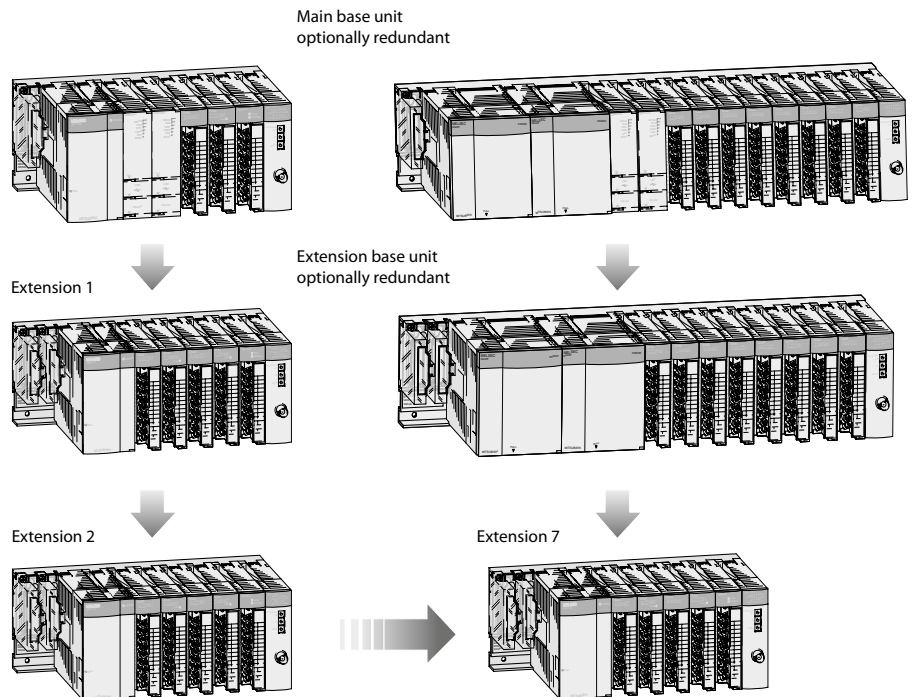

## Module combinations for multiple CPU system

### Multiple CPU high-speed main base unit (Q3□DB)

CPU 2 to 4		High-speed universal model QCPU	Universal model QCPU	Process CPU	Motion CPU/ Robot CPU <sup>①</sup> /CNC CPU	C Controller CPU		
CPU 1		Q03UDV Q04UDV Q06UDV Q13UDV Q26UDV	Q03UD(E) Q04UD(E)H Q06UD(E)H Q10UD(E)H Q13UD(E)H Q20UD(E)H Q26UD(E)H Q50UDEH Q100UDEH	Q02PH Q06PH Q12PH Q25PH	Q172DS Q173DS CR750-Q CR751-Q Q173NC	Q24DHCCPU-V Q24DHCCPU-VG Q24DHCCPU-LS Q12DCCPU-V	Q06CCPU-V	
		High-speed universal model QCPU	Q03UDV	●	●	○	●	●
	Q04UDV	●	●	○	●	●	—	
	Q06UDV	●	●	○	●	●	—	
	Q13UDV	●	●	○	●	●	—	
	Q26UDV	●	●	○	●	●	—	
Universal model QCPU	Q00U	—	—	—	—	○	○	
	Q01U	—	—	—	—	○	○	
	Q02U	—	—	—	—	○	○	
	Q03UD(E)	●	●	○	●	●	○	
	Q04UD(E)H	●	●	○	●	●	○	
	Q06UD(E)H	●	●	○	●	●	○	
	Q10UD(E)H	●	●	○	●	●	○	
	Q13UD(E)H	●	●	○	●	●	○	
	Q20UD(E)H	●	●	○	●	●	○	
	Q26UD(E)H	●	●	○	●	●	○	
	Q50UDEH	●	●	○	●	●	○	
	Q100UDEH	●	●	○	●	●	○	

### Main base unit other than (Q3□DB)

CPU 2 to 4		High-speed universal model QCPU	Universal model QCPU	Process CPU	Motion CPU/ Robot CPU <sup>①</sup> /CNC CPU	C Controller CPU		
CPU 1		Q03UDV Q04UDV Q06UDV Q13UDV Q26UDV	Q03UD(E) Q04UD(E)H Q06UD(E)H Q10UD(E)H Q13UD(E)H Q20UD(E)H Q26UD(E)H Q50UDEH Q100UDEH	Q02PH Q06PH Q12PH Q25PH	Q172DS Q173DS CR750-Q CR751-Q Q173NC	Q24DHCCPU-V Q24DHCCPU-VG Q24DHCCPU-LS Q12DCCPU-V	Q06CCPU-V	
		High-speed universal model QCPU	Q03UDV	○	○	○ <sup>②</sup>	—	○ <sup>④</sup>
	Q04UDV	○	○	○ <sup>②</sup>	—	○ <sup>④</sup>	—	
	Q06UDV	○	○	○ <sup>②</sup>	—	○ <sup>④</sup>	—	
	Q13UDV	○	○	○ <sup>②</sup>	—	○ <sup>④</sup>	—	
	Q26UDV	○	○	○ <sup>②</sup>	—	○ <sup>④</sup>	—	
Universal model QCPU	Q00U	—	—	—	—	○ <sup>④</sup>	○ <sup>④</sup>	
	Q01U	—	—	—	—	○ <sup>④</sup>	○ <sup>④</sup>	
	Q02U	—	—	—	—	○ <sup>④</sup>	○ <sup>④</sup>	
	Q03UD(E)	○	○	○ <sup>②</sup>	—	○ <sup>④</sup>	○ <sup>④</sup>	
	Q04UD(E)H	○	○	○ <sup>②</sup>	—	○ <sup>④</sup>	○ <sup>④</sup>	
	Q06UD(E)H	○	○	○ <sup>②</sup>	—	○ <sup>④</sup>	○ <sup>④</sup>	
	Q10UD(E)H	○	○	○ <sup>②</sup>	—	○ <sup>④</sup>	○ <sup>④</sup>	
	Q13UD(E)H	○	○	○ <sup>②</sup>	—	○ <sup>④</sup>	○ <sup>④</sup>	
	Q20UD(E)H	○	○	○ <sup>②</sup>	—	○ <sup>④</sup>	○ <sup>④</sup>	
	Q26UD(E)H	○	○	○ <sup>②</sup>	—	○ <sup>④</sup>	○ <sup>④</sup>	
	Q50UDEH	○	○	○ <sup>②</sup>	—	○ <sup>④</sup>	○ <sup>④</sup>	
	Q100UDEH	○	○	○ <sup>②</sup>	—	○ <sup>④</sup>	○ <sup>④</sup>	

● = available ○ = optional — = not available

**Notes:**

- ① The robot CPU includes CR750-Q, CR751-Q.
- ② The slim type main base unit (Q3□SB) cannot be used.
- ③ Can only use 1x Motion CPU.
- ④ In case of using Q06CCPU-V or Q12DCCPU-V, the redundant power main base unit (Q3□RB) cannot be used.
- ⑤ Cannot be used together with Q03UD(E), Q04UD(E)H, Q06UD(E)H, Q10UD(E)H, Q13UD(E)H, Q20UD(E)H, Q26UD(E)H, Q50UDEH, Q100UDEH, Q03UDV, Q04UDV, Q06UDV, Q13UDV, Q26UDV/CPU or Q12DCCPU-V..

■ Main base units

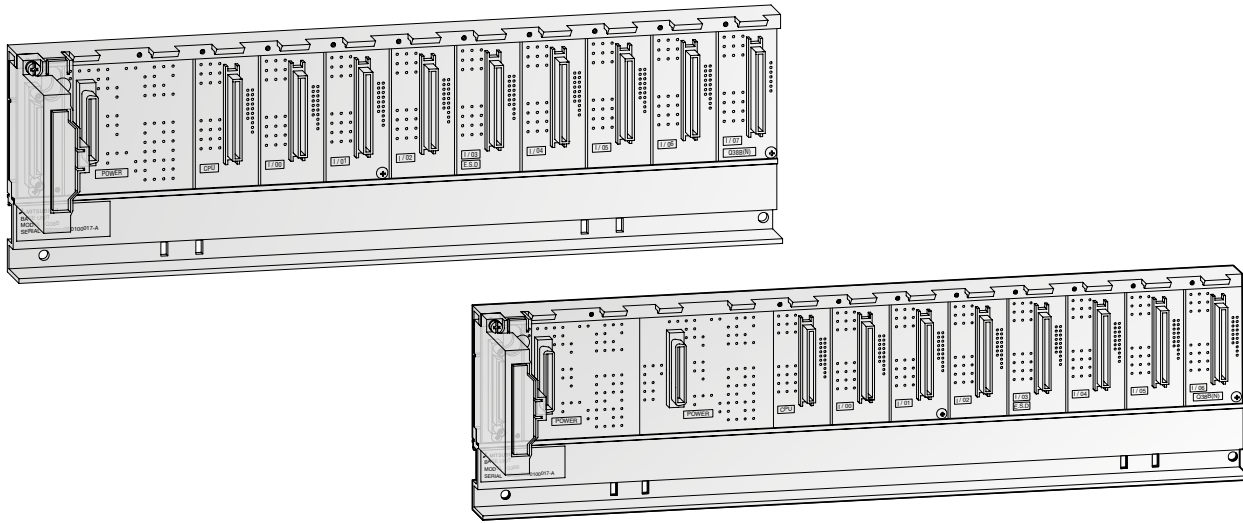

3  
MELSEC System Q

**Main base unit**

The main base unit is used for holding and coupling CPUs, power supply unit, input modules, output modules, special function modules and field bus connections.

**Special features:**

- Module addressing is automatic and it is assumed that the base units have 8 slots. Sixteen addresses are assigned to empty slots and non-existent slots (in base units with less than 8 slots). The automatic addressing can be changed with the I/O Assignment function.
- Base units with slots for two redundant power supplies increase the availability of the system.
- The units are mounted by means of screws or on a profiled rail with an integrated adapter.

Specifications	Q325B	Q33B	Q335B	Q35B	Q355B	Q35DB	Q38B	Q38DB*	Q38RB*	Q312B*	Q312DB*	
Slots for I/O modules	2	3	3	5	5	5	8	8	8	12	12	
Slots for power supply modules	1	1	1	1	1	1	1	1	2	1	1	
Installation	All base units provide installation holes for M4 screws.											
Dimensions (WxHxD)	mm	114x98x18.5	189x98x44.1	142x98x18.5	245x98x44.1	197.5x98x18.5	245x98x44.1	328x98x44.1	328x98x44.1	439x98x44.1	439x98x44.1	439x98x44.1
<b>Order information</b>	Art. no.	147273	136369	147284	127586	147285	249091	127624	207608	157573	129566	207609
Accessories	Connection cables; adapter for DIN rail mounting > refer to chapter 5											

\*These base units are required for the new iQ Platform motion, NC and robot CPUs.

**Safety main base unit**

The safety main base unit holds and connects the safety CPU and up to two CC-Link safety master modules and Ethernet modules.

**Special features:**

- Automatic module addressing
- The base unit is mounted by means of screws or on a profiled rail with an integrated adapter.

Specifications	Q5034B										
Slots for I/O modules	4										
Slots for power supply modules	1										
Internal power consumption (5 V DC)	0.095 A										
Installation	Provides installation holes for M4 screws.										
Dimensions (WxHxD)	mm	245x98x44.1									
<b>Order information</b>	Art. no.	203206									
Accessories	Connection cables; adapter for DIN rail mounting > refer to chapter 5										



## ■ Extension base units

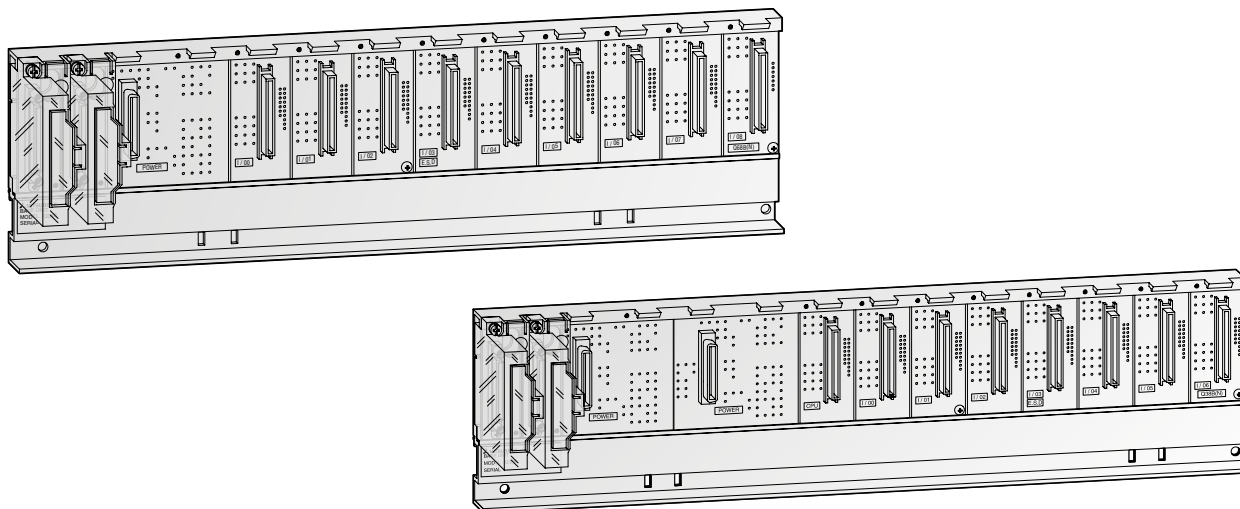

### Extension base units

The extension base units are connected to the main base unit by means of assembled bus cables. Thus, a MELSEC System Q can be expanded to max. 7 extension units with up to 64 I/O modules.

The extension units provide a slot for their own power supply module.

With the redundant type extension base unit Q65WRB, I/O modules can be directly connected to a redundant system.

The extension base unit QA1S51B is used to connect a module of the AnS series to the MELSEC System Q.

### Special features:

- Q6□B extension units provide a slot for their own power supply module
  - A total of max.7 extension units can be connected to a main base unit with up to 64 I/O modules for a single system
  - The maximum distance from the first to the last base unit is 13.2 m.
  - Base units with slots for two redundant power supplies increase the availability of the system.
- An extension base unit with a power supply module must be used in the following cases:
- If the power consumption of the inserted modules exceeds the capacity of the power supply module on the base unit.
  - If the voltage drops below 4.75 V between the base unit and the extension unit.

Specifications	Q52B	Q55B	Q63B	Q65B	Q68B	Q68RB	Q612B	Q65WRB	QA1S51B	
Slots for power supply modules	—	—	1	1	1	2	1	1	—	
Slots for I/O modules	2	5	3	5	8	8	12	5	1	
Installation	All base units provide installation holes for M4 screws.									
Weight	kg	0.14	0.23	0.23	0.25	0.35	0.45	0.45	0.52	0.23
Dimensions (WxHxD)	mm	106x98x44.1	189x98x44.1	189x98x44.1	245x98x44.1	328x98x44.1	439x98x44.1	439x98x44.1	439x98x44.1	100x130x50.7
<b>Order information</b>	Art. no.	140376	140377	136370	129572	129578	157066	129579	210163	249092
Accessories	Connection cables; adapter for DIN rail mounting > refer to chapter 5									

■ Power supply modules

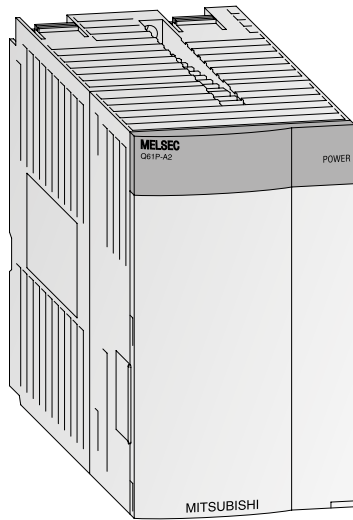

**Power supply modules**

The power supply modules supply the voltages required for operation to the the individual modules. The choice is dependent on the power consumption of the individual modules (this is especially important when using multiple CPUs.)

**Special features:**

- The readiness for operation is indicated by a LED.
- By use of the power supply Q63P it is possible that controllers can be supplied by means of additional 24 V DC output.
- The power supply modules Q62P can be used world-wide because they support the wide input range from 100 to 240 V AC at 50/60 Hz.
- The Q63RP and Q64RPN power supplies can be used with all CPUs (except the Q00JCPU) to increase the system availability level. All redundant power supplies can be replaced while the system is in RUN mode without interrupting control operation.
- Two redundant power supplies in a redundant base unit are required for a redundant power supply configuration.

Specifications		Q61P	Q61P-D	Q61SP	Q62P	Q63P	Q63RP	Q64PN	Q64RPN	QS061P-A1	QS061P-A2
Input voltage	(+10 %, -15 %) V AC	85–264	100–240	85–264	100–240	—	—	100–240	100–240	100–120	200–240
	(+30 %, -35 %) V DC	—	—	—	—	24	24	—	—	—	—
Input frequency	Hz	50/60 (±5 %)	50/60 (±5 %)	50/60 (±5 %)	50/60 (±5 %)	—	—	50/60 (±5 %)	50/60 (±5 %)	50/60 (±5 %)	50/60 (±5 %)
Inrush current		20 A within 8 ms	20 A within 8 ms	20 A within 8 ms	20 A within 8 ms	81 A within 1 ms	150 A within 1 ms	20 A within 1 ms	20 A within 1 ms	20 A within 8 ms	20 A within 8 ms
Max. input apparent power		120 VA	130 VA	40 VA	105 VA	45 W	65 W	160 VA	160 VA	125 VA	125 VA
Rated output current	5 V DC	A	6	2	3	6	8.5	8.5	8.5	6	6
	24 V DC ±10 %	A	—	—	0.6	—	—	—	—	—	—
Overcurrent protection	5 V DC	A	≥6.6	≥6.6	≥2.2	≥3.3	≥5.5	≥5.5	≥9.9	≥14.4	≥6.6
	24 V DC	A	—	—	—	≥0.66	—	—	—	—	—
Overvoltage protection	5 V DC	V	5.5–6.5	5.5–6.5	5.5–6.5	5.5–6.5	5.5–6.5	5.5–6.5	5.5–6.5	5.5–6.5	5.5–6.5
Efficiency			≥70 %	≥70 %	≥65 %	≥70 %	≥70 %	≥65 %	≥70 %	≥65 %	≥70 %
Insulation withstand voltage	Between primary and 5 V DC		2830 V AC, 1 min.	2830 V AC, 1 min.	2830 V AC, 1 min.	2830 V AC, 1 min.	500 V AC, 1 min.	500 V AC, 1 min.	2830 V AC, 1 min.	2830 V AC, 1 min.	2830 V AC, 1 min.
	Between primary and 24 V DC		—	—	—	2830 V AC, 1 min.	—	—	—	—	—
Max. compensation time at power failure	ms	20	20	20	20	10	10	20	20	20	20
Power indicator		All modules possess a power LED display.									
Terminal screw size		All modules possess terminal screw size M 3.5 x 7 mm.									
Applicable wire size	mm <sup>2</sup>	0.75–2 (AWG 18–14)	0.75–2 (AWG 18–14)	0.75–2 (AWG 18–14)	0.3–2 (AWG 18–14)	0.3–2 (AWG 16–22)	0.75–2 (AWG 16–22)	0.75–2 (AWG 11–22)	0.75–2 (AWG 11–22)	0.75–2	0.75–2
Weight	kg	0.30	0.30	0.39	0.50	0.47	0.40	0.47	0.47	0.40	0.40
Dimensions (WxHxD)	mm	55.2x98x90	55.2x98x90	27.4x98x104	55.2x98x90	55.2x98x90	83x98x115	55.2x98x115	55.2x98x115	55.2x98x115	55.2x98x115
<b>Order information</b>	Art. no.	190235	221860	147286	140379	136371	166091	217627	157065	203207	203208

## ■ Universal PLC CPUs

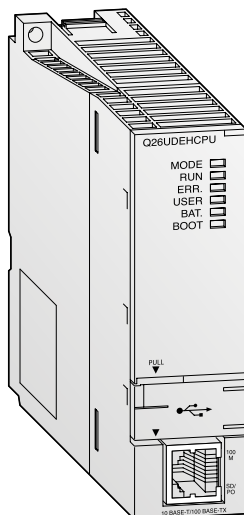

These universal PLC CPUs are the latest generation of modular CPUs for the MELSEC System Q controller platform and they are the foundation of the iQ Platform system. They can be combined with the motion, robot and NC CPUs to configure scalable and highly flexible modular automation systems.

### Special features:

- Integrated mini USB interface for programming
- Integrated Ethernet interface for efficient communication with the Q□UDEH modules
- Extremely fast bit processing, 9.5 ns
- High-speed data access
- Q□UDVCPUs enable high-speed program processing
- SD memory card and SRAM cassette installable in Q□UDVCPU

Specifications	Q00UCPU	Q00UCPU	Q01UCPU	Q02UCPU	Q03UDCPU, Q03UDECPU	Q04UDHCPU, Q04UDEHCPU	
Type	Multi processor CPU module						
I/O points	256/8192	1024/8192	1024/8192	2048/8192	4096/8192	4096/8192	
CPU self-diagnostic functions	CPU error detection, Watch Dog, battery error detection, memory error detection, program check, power supply error detection, fuse error detection						
Battery buffer	All CPU modules are fitted with a lithium-battery with a life expectancy of 5 years.						
Memory type	RAM, ROM, FLASH	RAM, ROM, FLASH	RAM, ROM, FLASH	RAM, ROM, FLASH	RAM, ROM, FLASH	RAM, ROM, FLASH	
Memory capacity	Overall	≤32 MByte	≤32 MByte	≤32 MByte	≤32 MByte	≤32 MByte	
	Max. for PLC program	10 k steps (40 kByte)	10 k steps (40 kByte)	15 k steps (60 kByte)	20 k steps (80 kByte)	30 k steps (120 kByte)	40 k steps (160 kByte)
Instruction processing time	120 ns/log. instruction	80 ns/log. instruction	60 ns/log. instruction	40 ns/log. instruction	20 ns/log. instruction	9.5 ns/log. instruction	
Dimensions (WxHxD)	mm	245x98x98	27.4x98x89.3	27.4x98x89.3	27.4x98x89.3	27.4x98x89.3	
<b>Order information</b>	Art. no.	221575	221576	221577	207604	207605, 217899	207606, 217900

Specifications	Q06UDHCPU, Q06UDEHCPU	Q10UDHCPU, Q10UDEHCPU	Q13UDHCPU, Q13UDEHCPU	Q20UDHCPU, Q20UDEHCPU	Q26UDHCPU, Q26UDEHCPU	Q50UDEHCPU	Q100UDEHCPU	
Type	Multi processor CPU module							
I/O points	4096/8192	4096/8192	4096/8192	4096/8192	4096/8192	4096/8192	4096/8192	
CPU self-diagnostic functions	CPU error detection, Watch Dog, battery error detection, memory error detection, program check, power supply error detection, fuse error detection							
Battery buffer	All CPU modules are fitted with a lithium-battery with a life expectancy of 5 years.							
Memory type	RAM, ROM, FLASH	RAM, ROM, FLASH	RAM, ROM, FLASH	RAM, ROM, FLASH	RAM, ROM, FLASH	RAM, ROM, FLASH	RAM, ROM, FLASH	
Memory capacity	Overall	≤32 MByte	≤32 MByte	≤32 MByte	≤32 MByte	≤32 MByte	≤32 MByte	
	Max. for PLC program	60 k steps (240 kByte)	100 k steps (400 kByte)	130 k steps (520 kByte)	200 k steps (800 kByte)	260 k steps (1040 kByte)	500 k steps (2000 kByte)	1000 k steps (4000 kByte)
Instruction processing time	9.5 ns/ log. instruction	9.5 ns/ log. instruction	9.5 ns/ log. instruction	9.5 ns/ log. instruction	9.5 ns/ log. instruction	9.5 ns/ log. instruction	9.5 ns/ log. instruction	
Dimensions (WxHxD)	mm	27.4x98x89.3	27.4x98x89.3	27.4x98x89.3	27.4x98x89.3	27.4x98x115	27.4x98x115	
<b>Order information</b>	Art. no.	207607, 215808	221578, 221579	217619, 217901	221580, 221581	217620, 217902	242368	242368

Specifications	Q03UDVCPU	Q04UDVCPU	Q06UDVCPU	Q13UDVCPU	Q26UDVCPU	
Type	Multi processor CPU module					
I/O points	4096/8192					
CPU self-diagnostic functions	CPU error detection, Watch Dog, battery error detection, memory error detection, program check, power supply error detection, fuse error detection					
Battery buffer	All CPU modules are fitted with a lithium-battery with a life expectancy of 5 years.					
Memory type	RAM, ROM, FLASH, SD-Card, extended SRAM cassette					
Memory capacity for PLC program	30 k steps (120 kByte)	40 k steps (160 kByte)	60 k steps (240 kByte)	130 k steps (520 kByte)	260 k steps (1040 kByte)	
Instruction processing time	1.9 ns/log. instruction	1.9 ns/log. instruction	1.9 ns/log. instruction	1.9 ns/log. instruction	1.9 ns/log. instruction	
Dimensions (WxHxD)	mm	27.4x98x115	27.4x98x115	27.4x98x115	27.4x98x115	
<b>Order information</b>	Art. no.	266161	266162	266163	266164	266165

Accessories	Q4MCA-1MBS; 1 MB memory cassette for Q□UDVCPU Q4MCA-2MBS; 2 MB memory cassette for Q□UDVCPU Q4MCA-4MBS; 3 MB memory cassette for Q□UDVCPU Q4MCA-8MBS; 4 MB memory cassette for Q□UDVCPU	Art. no. 266134; Art. no. 266155; Art. no. 266156 Art. no. 266157
-------------	--	--

■ Process CPU modules

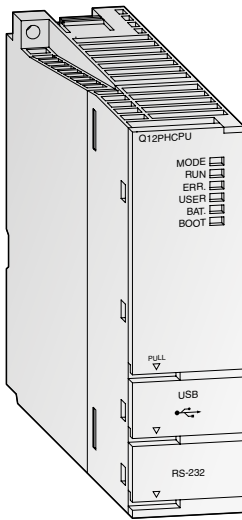

The MELSEC System Q process CPU allows flexible system design based on off-the-shelf components, which reduces both initial and implementation costs. Using either PX Developer or GX Developer, process applications can be designed, debugged, monitored and maintained. The MELSEC process control system is best suited for food manufacturing and chemical plant applications, where liquid or solid materials are stored in a tank and a level must be maintained within a specific range. The process CPU combines DCS functions with PLC operability into one compact module.

**Special features:**

- Simplified control and engineering
- Extensive Loop control
- High-speed Loop control
- Improved reliability and serviceability
- Hot-swap module replacement in run mode
- Works with CC-Link IE, MELSECNET/H for multiplex remote I/O system
- Loop Control and sequence control with one CPU
- Utilisation and expandability
- Use with isolated analog modules, ideal for process control
- Smoothed analog input value

Specifications	Q02PHCPU	Q06PHCPU	Q12PHCPU	Q25PHCPU
Type	Process CPU module			
I/O points	4096/8192	4096/8192	4096/8192	4096/8192
CPU self-diagnostic functions	CPU error detection, Watch Dog, battery error detection, memory error detection, program check, power supply error detection, fuse error detection			
Multiprocessor mode	Up to 4 CPU modules can be used in combination on one base unit.			
Battery buffer	All CPU modules are fitted with a lithium-battery with a life expectancy of 5 years.			
Memory type	RAM, ROM, FLASH	RAM, ROM, FLASH	RAM, ROM, FLASH	RAM, ROM, FLASH
Memory capacity	Overall ≤32 MByte Max. for PLC program 28 k steps (112 kByte)	Overall ≤32 MByte 60 k steps (240 kByte)	Overall ≤32 MByte 124 k steps (496 kByte)	Overall ≤32 MByte 252 k steps (1008 kByte)
Instruction processing time	34 ns/log. instruction	34 ns/log. instruction	34 ns/log. instruction	34 ns/log. instruction
Timer (T)	2048	2048	2048	2048
Counter (C)	1024	1024	1024	1024
Internal/special relay (M)	8192	8192	8192	8192
Data register/special register (D)	12288	12288	12288	12288
File register (R) ①	65536/ max. 1042432	65536/ max. 1042432	131072/ max. 1042432	131072/ max. 1042432
Interrupt pointer (I)	256	256	256	256
Pointer (P)	4096	4096	4096	4096
Annunciator (F)	2048	2048	2048	2048
Index register (Z)	16	16	16	16
Link relay (B)/link register (W)	8192/8192	8192/8192	8192/8192	8192/8192
Number of connectable extensions	7	7	7	7
Max. number of insertable modules	64	64	64	64
Internal power consumption (5 V DC)	mA 640	640	640	640
Max. compensation time at power failure	ms Varies according to the type of power supply module used			
Weight	kg 0.20	0.20	0.20	0.20
Dimensions (WxHxD)	mm 27.4x98x89.3	27.4x98x89.3	27.4x98x89.3	27.4x98x89.3
<b>Order information</b>	Art. no. 218138	218139	143529	143530
Accessories	Software PX-Developer optional			

① Number depends on memory configuration

## ■ Redundant PLC CPU modules

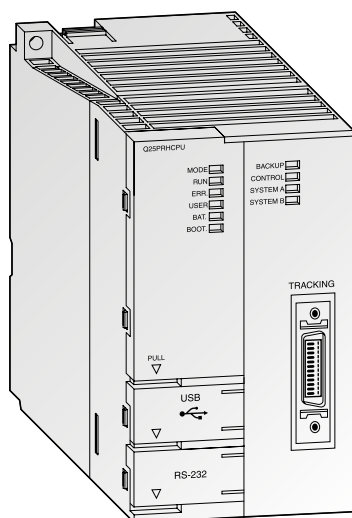

### Redundant PLC CPU modules

In a redundant setup two identically-configured systems are automatically kept synchronised to provide "hot standby" functionality, thus guaranteeing maximum availability and failsafe performance. This significantly reduces down time and restart overheads and costs. The higher purchase price of redundant systems are negligible when compared to the costs they can save in the event of a failure.

If the active system fails the hot standby system cuts in automatically and takes over, without any interruption.

The system's modular architecture makes it possible to implement different levels of redundancy, as required: Power supply redundancy, master redundancy and controller redundancy.

### Special features:

- QnPRH is based on standard components, so existing peripherals can be used.
- Complete integration in existing and non-redundant environments possible.
- Very short switching times possible – user-configurable, min. switching time 22 ms (48 k words).
- Programmable just like a normal system, using standard software.
- Automatic detection of the active system with MX Components/ MX OPC Server communicating with higher-level systems
- The I/O-level can be connected via MELSECNET/H network (redundant ring), CC-Link, CC-Link IE, Ethernet or Profibus.
- The availability of these networks can be increased by using redundant master modules.

Specifications	Q12PRHCPU	Q25PRHCPU
Type	Process CPU module, high availability	
I/O points	4096/8192	4096/8192
CPU self-diagnostic functions	CPU test, watchdog (time monitoring), battery check, memory test, program plausibility, mains power monitoring, redundancy synchronisation	
Multiprocessor mode	—	
Battery buffer	All CPUs are fitted with a lithium battery with a service life of 5 years.	
Memory type	RAM, ROM, FLASH	RAM, ROM, FLASH
Memory capacity	Overall ≤32 MByte	≤32 MByte
	Max. for PLC program 124 k steps (496 kByte)	252 k steps (1008 kByte)
Instruction processing time	34 ns/log. instruction	34 ns/log. instruction
Timer (T)	2048	2048
Counter (C)	1024	1024
Internal/special relay (M)	8192	8192
Data register/special register (D)	12288	12288
File register (R)	131072/max. 1042432	131072/max. 1042432
Interrupt pointer (I)	256	256
Pointer (P)	4096	4096
Annunciator (F)	2048	2048
Index register (Z)	16	16
Link relay (B)/link register (W)	8192/8192	8192/8192
Max. number of insertable modules	Max 11 in main base unit, 64 all via MELSECNET remote connection, no central extension unit can be connected	
Internal power consumption (5 V DC)	mA 640	640
Weight	kg 0.30	0.30
Dimensions (WxHxD)	mm 52.2x98x89.3	52.2x98x89.3
<b>Order information</b>	Art. no. 157070	157071
Accessories	Software PX-Developer (optional)	

\* Tracking cables QC10TR and QC30TR, refer to chapter 5

## ■ PC CPU modules

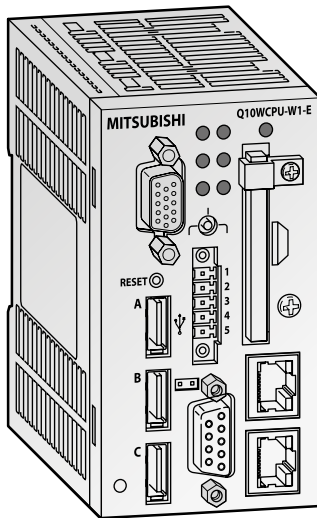

### The Windows®-CPU

The Q10WCPU uses the Microsoft Windows® operating system and can be combined with the power supplies, racks, I/O and special modules from the MELSEC System Q. The CPU module can be used in stand-alone mode or in multi-CPU mode, in conjunction with PLC CPU modules for example. This enables a seamless connection between the process and the data processing system. While the PLC CPU modules control and regulate processes, the Q10WCPU undertakes the conditioning and processing of data. The Q10WCPU-W1-E boots up from the integral solid-state drive (SSD) or from an installed Type 1 CF memory card (Q10WCPU-W1-CFE). The two integral LAN interfaces allow the unit to be incorporated in networks and enable access to Intranet and Internet. The hardware has been implemented by means of an embedded CPU and a proven chipset. The use of easily available components ensures that this CPU module can be applied with ease. In addition, the self-adapting BIOS enables support right at the BIOS level.

### Special features:

- Windows® operating system in a module with small dimensions (double the width of a MELSEC System Q PLC CPU module).
- Energy-saving by using an Intel Atom N450 processor. Various options for saving energy are adjustable. This ensures adequate performance and low energy consumption.
- Equipped with a variety of interfaces as standard (1000BASE-T (LAN), USB 2.0, CF-Card etc.).
- The customizable Phoenix Award BIOS enables support right at the BIOS level.
- A CF memory card can be installed as an external storage medium (Q10WCPU-W1-CFE)
- The integrated Solid State Drive (SSD) has a double write protection function and thus provides a reliable protection for important data.

Specifications	Q10WCPU-W1-E	Q10WCPU-W1-CFE
Type	Personal Computer CPU	
CPU	Intel® Atom™ Processor N450 1.66 GHz	
Chip set	Intel® ICH8M	
Processing frequency	GHz 1.66	
Memory	L1 cache	Instruction 32 kB + data 24 kB
	L2 cache	512 kB
	Main	1 GB
Video	Analog-RGB, resolution 1400 x 1050 at 60 Hz (16 million colors)	
Interfaces	Serial (RS232C)	One 9-pin D-SUB connector, transfer rate: 50–115200 bps
	USB	Five USB2.0 compliant ports (3 at the front and 2 at the rear)
	Keyboard/mouse	Connection via one of the USB ports
	LAN	Two RJ45 sockets for 1000BASE-T/100BASE-TX/10BASE-T
	Monitor	1x15-pin H-DSUB
PC card slots	1 slot for CF memory card (type I)	
Internal power consumption (5 V DC)	A Max. 3	
Weight	kg 0.44	0.45
Dimensions (WxHxD)	mm 55.2x98.0x115	
<b>Order information</b>	Art. no. 252826	252827

## ■ C Controller CPU

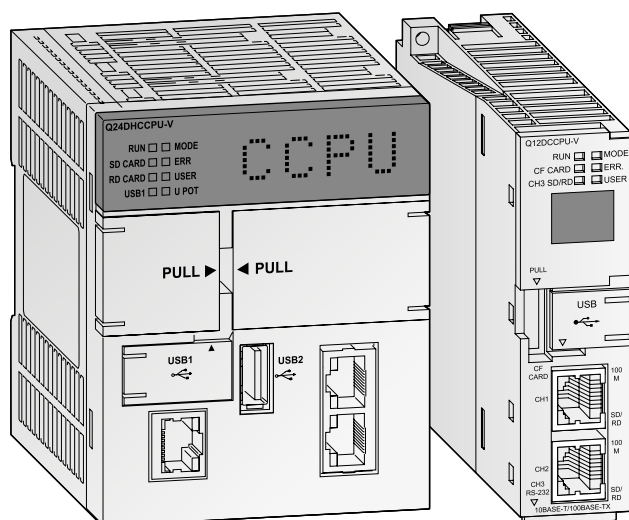

### High-level language programming in combination with real time operating system

The C Controller allow the integration and programming of the automation platform MELSEC System Q with C++. Using the worldwide established real time operating system VxWorks, realisation of complex tasks, communication and protocols becomes easy.

### Special features:

- Integration in the multi CPU layout of MELSEC System Q through combination with PLC and Motion CPUs or use as stand-alone system.
- Real time operating system VxWorks
- Dedicated development environment of C-/C++ language
- CompactFlash card makes handling of large quantities of data easy
- High performance addition to the existing range of automation products
- 7-segment LED display for efficient debugging and troubleshooting (Q12CCPU-V only)
- Ethernet and RS232 interface on board
- Q12DCCPU-V and Q24DHCCPU-□ with additional USB interface
- Real time OS VxWorks (except Q24/Q26DHCCPU-LS) and Telnet pre-installed
- Standard C/C++ Code can be embedded
- Remote access via networks und support of FTP
- VxWorks communication library and QBF libraries for easy setup
- CODESYS compatibility
- PCI Express extension connector (Q24DHCCPU-□)
- User programmable display (Q24DHCCPU-□ and Q26DHCCPU-LS only)
- Linux OS support (Q24DHCCPU-LS)

Specifications	Q12DCCPU-V	Q24DHCCPU-V	Q24DHCCPU-LS
Number of I/Os	4096 (X/Y0-X/YFFF)	4096 (X/Y0-X/YFFF)	4096 (X/Y0-X/YFFF)
Memory	Standard RAM: 3 MB; Work RAM: 128 MB; Battery-backed-up RAM: 128 kB	Standard RAM: 0-4 MB; Standard ROM: 382 MB; Work RAM: 512 MB; Battery-backed-up RAM: 1-5 MB	Work RAM: 512 MB; Battery-backed-up RAM: 5 MB
Operating system	VxWorks Version 6.4 (preinstalled)	VxWorks® Version 6.8.1 (preinstalled)	No pre-installed operating system
Programming language	C or C++	C or C++	—
Development tool	CW Workbench, Setting/monitoring tools for C Controller	CW Workbench, Setting/monitoring tools for C Controller	CW Workbench, Setting/monitoring tools for C Controller
Communication interfaces	RS232 (1 ch.), 10BASE-T/100BASE-TX (2 ch.), USB (1 ch.)	Ethernet (3 ch.), USB (2x), PCI Express, RS232	Ethernet (3 ch.), USB (2x), PCI Express, RS232
Connection of external wiring	9-pin SubD (RS232), RJ45 (Ethernet)	9-pin SubD (RS-232), RJ45 (Ethernet), Analog RGB output connector, PCI Express extension connector, USB connector type A, USB connector type mini-B	
CF card I/F	1 slot for a TYPE I card (Max. 8 GB CF card is supported)	1 slot for SD memory card	1 slot for SD memory card
Integrated clock	Year, month, day, minute, second, weekday (automatic leap year adjustment)		
Max. compensation time at power failure	Depends on power supply		
Internal power consumption (5 V DC)	A 0.93	2.8	2.8
Weight	kg 0.24	0.63, 0.638 (VG type)	0.638
Dimensions (WxHxD)	mm 27.4x98x115	83x98x115	83x98x115
Order information	Art. no. 221925	260296	273605
Accessories	Programming via Ethernet, cross-link cable (X-Link) may be required. Programming software C Controller Configurator V0100-1LOC-E; art. no. 165367 A special development suite (Tornado, WindView, Sniff+) for the Q06CCPU is available worldwide from any Wind River branch, just quote our contract no. 209356. A free demo version is available for testing. The development tool Workbench 2.6.1 is available from Wind River Systems.		

■ Motion CPU modules

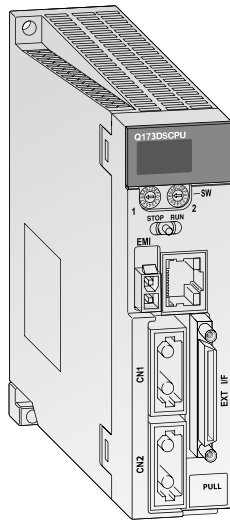

**The high-speed dynamic motion CPU**

The motion controller CPU controls and synchronizes the connected servo amplifiers and servo motors. A motion system besides the controller CPU as well includes a PLC CPU. Only after combining a highly dynamic positioning control and a PLC an innovative and autarkical motion control system is created.

While the Motion CPU controls large-scale servo movements the PLC CPU is responsible for the machine control and the communication at the same time.

**Special features:**

- Using multiple CPUs to distribute the load improves the overall performance of the whole system
- Use of up to 3 motion CPUs within one system
- Large scale control system for up to 96 axes per system
- Interpolation of 4 axes simultaneously
- Software cam control
- Virtual and real master axes
- Integration in the high-speed SSCNETIII/H network for communication with high-performance servo amplifiers at up to 150 Mbps

Specifications		Q172DSCPU	Q173DSCPU	
Type		Motion CPU	Motion CPU	
I/O points		8192	8192	
No. of control axes		16	32	
Interpolation functions		Linear interpolation for up to 4 axes, circular interpolation for 2 axes, helical interpolation for 3 axes		
Positioning	Method	PTP (point to point), speed control/speed-position control, fixed pitch feed, constant speed control, position follow-up control, speed switching control, high-speed oscillation control, synchronous control (SV22)		
	Acceleration/deceleration control	Automatic trapezoidal acceleration/deceleration, S-curve acceleration/deceleration		
	Compensation	Backlash compensation, electronic gear		
Programming language		Motion SFC, dedicated instructions, software for conveyor assembly (SV13), virtual mechanical support language (SV22)		
Processing speed	SV13	0.22 ms (1.–4. axis), 0.44 ms (5.–10. axis), 0.88 ms (11.–16. axis)	0.22 ms (1.–4. axis), 0.44 ms (5.–10. axis), 0.88 ms (11.–24. axis), 1.77 ms (25.–32. axis)	
	SV22	0.44 ms (1.–6. axis), 0.88 ms (7.–16. axis)	0.44 ms (1.–6. axis), 0.88 ms (7.–16. axis), 1.77 ms (17.–32. axis)	
Program capacity		16 k steps	16 k steps	
No. of positioning points		3200		
Program execution	Number of multi executed programs	Max. 256		
	Number of multi active steps	Max. 256 steps in all programs		
	Executed tasks	normal	Executed in motion main cycle	
		interrupt	Executed in fixed cycles (0.88 ms, 1.7 ms, 3.5 ms, 7.1 ms, 14.2 ms), 16 external interrupt points (QI60 interrupt module inputs), executed with interrupt from PLC CPU (when executing the S(P).GINT instruction)	
	NMI	16 points; executed when input ON is set among an interrupt module (e.g. QI60)		
Interfaces		SSCNETIII/H (USB, RS232C via PLC CPU)		
Real I/O points (PX/PY)		256 (these I/Os can be allocated directly to the motion CPU)		
Certifications		CE, UL & cUL		
Internal power consumption (5 V DC)	A	1.44	1.75	
Weight	kg	0.38	0.38	
Dimensions (WxHxD)	mm	27.4x120.5x120.3	27.4x120.5x120.3	
<b>Order information</b>	Art. no.	248700	248701	
Accessories		Interface modules for manual pulse generator, encoder and external signals (for detailed information please refer to the catalogue "Motion Controller MELSEC System Q")		



## ■ Safety CPU module

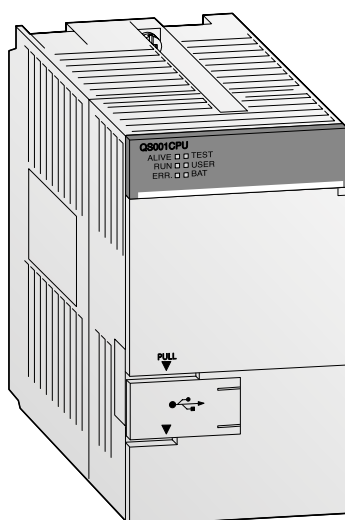

### Safety control with QS safety PLC

The CC-Link safety network eliminates the complex wiring needed in conventional safety controller systems. The remote safety I/O stations are connected to the CC-Link safety master module in the safety PLC using standard CC-Link cables. In the event of communications errors powerful and effective error identification routines automatically switch off the outputs of both the safety PLC and the remote safety I/O stations.

CC-Link safety is also compatible with CC-Link. This means you can also use standard CC-Link I/O modules in a CC-Link safety network for those inputs and outputs that are not critical for safety.

### Special features:

- Conforms to the safety requirements of EN 954-1 Category 4, ISO 13849-1 PL e, and IEC 61508 (JIS C 0508) SIL 3 and certified by TÜV Rheinland
- Automatic checking of safety inputs and outputs and external devices (cable breaks, short circuits, fused contactor contacts etc.)
- Program and configure with the familiar GX Developer programming software packages. No new skills or software are required.
- Reduced wiring requirements cuts costs
- Comprehensive diagnostics functions
- Versatile: A single safety CPU can control up to 84 remote safety stations
- The CC-Link standard enables connection of third-party products compatible with the safety concept

Specifications	QS001 CPU
I/O points	4096/8192
Control method	Cyclic program execution
Programming language (Sequence Control)	Relay symbol language, function block
Processing speed	0.10–0.35 $\mu$ s
Constant scan	1–2,000 ms (setting unit: 1 ms)
Program capacity	14 k steps (56 kB)
Memory capacity	128 kB
Max. number of stored files	3
Internal relay (M)	6144
Link relay (B)	2048
Timer (T)	512
Counter (C)	512
Data register (D)	6144
Link register (W)	2048
Annunciator (F)	1024
RUN/PAUSE contact	RUN contact: 1 point can be set in the range of X0 to 17FF, PAUSE contact: none
Clock function	Year, month, date, hour, minute, second, day (automatic leap-year detection)
Internal power consumption(5V DC)	A 0.43
Weight	kg 0.29
Dimensions (WxHxD)	mm 55.2x98x113.8
<b>Order information</b>	Art. no. 203205

■ Digital input modules

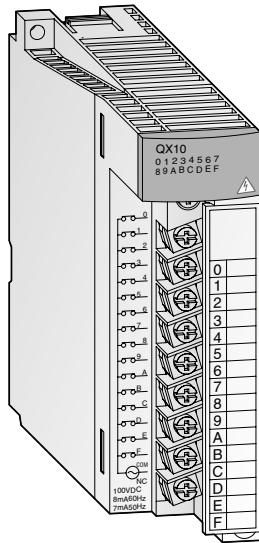

**Detection of process signals**

Various input modules are available for converting the digital process signals with different voltage levels into the levels required by the PLC.

**Special features:**

- Potential isolation between process and control by means of an opto-coupler is a standard feature.
- Indication of input status via LEDs
- Modules with 16 connection points have removable terminal blocks with screws.
- Assembled cables are available for modules with plugs.
- Different system terminals for module wiring simplification are available.
- Response time as low as 0.1 ms for high-speed input modules QX40-S1, QX41-S1 and QX42-1.

Specifications	QX10	QX10-TS	QX28	QX40	QX40-TS	QX40-S1	QX41	QX41-S1	QX41-S2	QX42	QX42-S1
Input points	16	16	8	16	16	16	32	32	32	64	64
Insulation method	Photocoupler insulation between input terminals and PC power for all modules.										
Rated input voltage	100–120 V AC (50/60 Hz)	100–120 V AC (50/60 Hz)	100–240 V AC (50/60 Hz)	24 V DC	24 V DC	24 V DC	24 V DC	24 V DC	24 V DC	24 V DC	24 V DC
Operating voltage range V	85–132	85–132	85–264	20.4–28.8	20.4–28.8	20.4–28.8	20.4–28.8	20.4–28.8	20.4–28.8	20.4–28.8	20.4–28.8
Max. simultaneously ON (at rated voltage)	100 % <sup>②</sup>	100 % <sup>②</sup>	100 %	100 % (sink type)	100 % (sink type)	100 % (sink type)	100 % (sink type)	100 % <sup>②</sup> (sink type)	100 % <sup>②</sup> (sink type)	100 % <sup>②</sup> (sink type)	100 % <sup>②</sup> (sink type)
Inrush current	200 mA for 1 ms (at 132 V AC)	200 mA for 1 ms (at 132 V AC)	200 mA for 1 ms (at 132 V AC)	—	—	—	—	—	—	—	—
Rated input current mA	7 (100 V AC, 50 Hz), 8 (100 V AC, 60 Hz)	8 (100 V AC, 60 Hz), 7 (100 V AC, 50 Hz)	7 (100 V AC, 50 Hz), 8 (100 V AC, 60 Hz), 14 (200 V AC, 50 Hz), 17 (200 V AC, 60 Hz)	Approx. 4	Approx. 4	Approx. 6	Approx. 4	Approx. 4	Approx. 6	Approx. 4	Approx. 4
ON	Voltage V ≥AC 80	≥AC 80	≥AC 80	≥DC 19	≥DC 19	≥DC 19	≥DC 19	≥DC 19	≥DC 15	≥DC 19	≥DC 19
	Current mA ≥AC 5	≥AC 5	≥AC 5	≥DC 3	≥DC 3	≥DC 4	≥DC 3	≥DC 3	≥DC 3	≥DC 3	≥DC 3
OFF	Voltage V ≤AC 30	≤AC 30	≤AC 30	≤DC 11	≤DC 11	≤DC 11	≤DC 11	≤DC 11	≤DC 9.5	≤DC 5	≥DC 11
	Current mA ≤AC 1	≤AC 1.7	≤AC 1	≤DC 1.7	≤DC 1.7	≤DC 1.7	≤DC 1.7	≤DC 1.7	≤DC 1.5	≤DC 1.7	≤DC 1.5
Load resistance kΩ	Approx. 18 (50 Hz), Approx. 15 (60 Hz)	Approx. 12 (50 Hz), Approx. 15 (60 Hz)	Approx. 15 (50 Hz), Approx. 12 (60 Hz)	Approx. 5.6	—	Approx. 3.9	Approx. 5.6	Approx. 5.6	Approx. 3.6	Approx. 5.6	Approx. 5.6
Response time	OFF → ON ms ≤15 (100 V AC, 50/60 Hz)	≤15 (100 V AC, 50/60 Hz)	≤15 (100 V AC, 50/60 Hz)	1–70 <sup>①</sup>	1–70 <sup>①</sup>	0.1–1 <sup>③</sup>	1–70 <sup>①</sup>	0.1–1 <sup>③</sup>	1–70 <sup>①</sup>	1–70 <sup>①</sup>	0.1–1 <sup>③</sup>
	ON → OFF ms ≤20 (100 V AC, 50/60 Hz)	≤20 (100 V AC, 50/60 Hz)	≤20 (100 V AC, 50/60 Hz)	1–70 <sup>①</sup>	1–70 <sup>①</sup>	0.1–1 <sup>③</sup>	1–70 <sup>①</sup>	0.1–1 <sup>③</sup>	1–70 <sup>①</sup>	1–70 <sup>①</sup>	0.1–1 <sup>③</sup>
Common terminal arrangement	16	16	8	16	16	16	32	32	32	32	32
Power indicator	All modules with 16 and 32 inputs possess a status LED per input. For modules with 64 inputs the indication is switchable.										
Connection terminal	18-point removable terminal block with screws	Removable terminal block with spring terminals	18-point removable terminal block with screws	18-point removable terminal block with screws	Removable terminal block with spring terminals	18-point removable terminal block with screws	40-pin connector	40-pin connector	40-pin connector	40-pin connector x 2	40-pin connector
Occupied I/O points	16	16	8	16	16	16	32	32	32	64	64
Applicable wire size mm <sup>2</sup>	0.3–0.75	0.3–0.75	0.3–0.75	0.3–0.75	0.3–0.75	0.3–0.75	0.3	0.088–0.3	0.088–0.3	0.3	0.088–0.3
Internal power consumption (5 V DC) mA	50 (all input points ON)	50 (all input points ON)	50 (all input points ON)	50 (all input points ON)	60 (all input points ON)	60 (all input points ON)	75 (all input points ON)	75 (all input points ON)	75 (all input points ON)	90 (all input points ON)	90 (all input points ON)
Weight kg	0.17	0.17	0.20	0.16	0.20	0.20	0.15	0.15	0.15	0.18	0.18
Dimensions (WxHxD) mm	27.4x98x90	27.4x98x90	27.4x98x90	27.4x98x90	27.4x98x90	27.4x98x90	27.4x98x90	27.4x98x90	27.4x98x90	27.4x98x90	27.4x98x90
Order inf.	Art. no. 129581	221838	136396	132572	221839	136574	132573	146921	229239	132574	146922
Accessories	37-pin connector, 40-pin connector and ready to use connection cables; spring clamp terminal block for exchange against the standard screw terminal block > refer to chapter 5										

① CPU parameter setting (default setting: 10 ms)  
 ② at 45 °C  
 ③ CPU parameter setting (default setting: 0.2 ms)

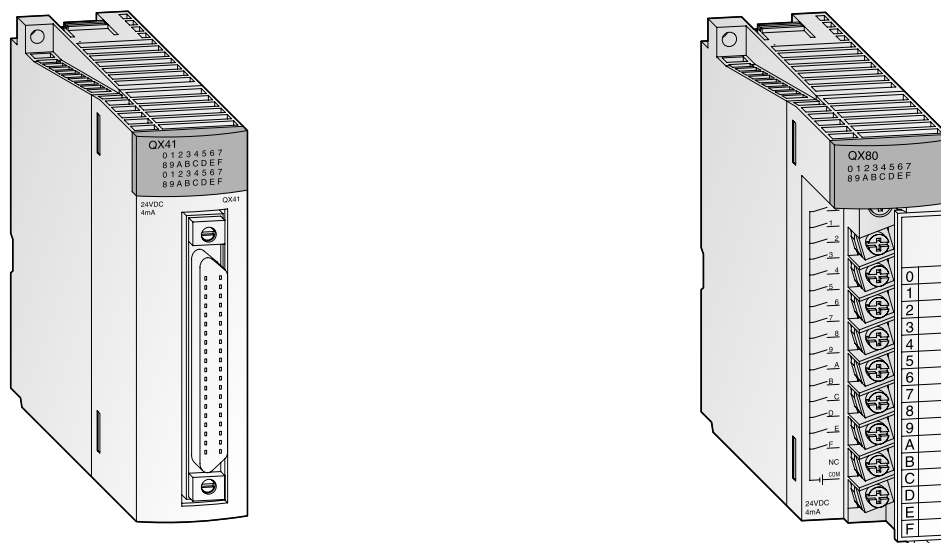

QX50	QX70	QX71	QX72	QX80	QX80-TS	QX81	QX81-S2	QX82	QX82-S1
16	16	32	64	16	16	32	32	64	64
48 V DC	5 V DC/12 V DC	5 V DC/12 V DC	5 V DC/12 V DC	24 V DC	24 V DC	24 V DC	24 V DC	24 V DC	24 V DC
40.8–52.8	4.5–6/10.2–14.4	4.5–6/10.2–14.4	4.5–6/10.2–14.4	20.4–28.8	20.4–28.8	20.4–28.8	20.4–28.8	20.4–28.8	20.4–28.8
100 %	100 %	100 %	100 %	100 %	100 %	100 %	100 % (at 40 °C)	100 % <sup>②</sup>	100 % <sup>②</sup>
—	—	—	—	—	—	—	—	—	—
Approx. 4	5 V DC: approx. 1.2 12 V DC: approx. 3.3	5 V DC: approx. 1.2 12 V DC: approx. 3.3	5 V DC: approx. 1.2 12 V DC: approx. 3.3	Approx. 4	Approx. 4	Approx. 4	Approx. 6	Approx. 4	Approx. 4
≥DC 28	≥DC 3.5	≥DC 3.5	≥DC 3.5	≥DC 19	≥DC 19	≥DC 19	≥DC 15	≥DC 19	≥DC 19
≥DC 2.5	≥DC 1	≥DC 1	≥DC 3	≥DC 3	≥DC 3	≥DC 3	≥DC 3	≥DC 3	≥DC 3
≥DC 10	≤DC 1	≤DC 1	≤DC 1	≤DC 11	≤DC 11	≤DC 11	≤DC 5	≤DC 11	≤DC 9.5
≥DC 1.7	≤DC 0.1	≤DC 0.1	≤DC 0.1	≤DC 1.7	≤DC 1.7	≤DC 1.7	≤DC 1.7	≤DC 1.7	≤DC 1.5
Approx. 11.2	Approx. 3.3	Approx. 3.3	Approx. 3.3	Approx. 5.6	Approx. 5.6	Approx. 5.6	Approx. 3.6	Approx. 5.6	Approx. 5.6
1–70 <sup>①</sup>	1–70 <sup>①</sup>	1–70 <sup>①</sup>	1–70 <sup>①</sup>	1–70 <sup>①</sup>	1–70 <sup>①</sup>	1–70 <sup>①</sup>	1–70 <sup>①</sup>	1–70 <sup>①</sup>	0.1–1 <sup>①</sup>
1–70 <sup>①</sup>	1–70 <sup>①</sup>	1–70 <sup>①</sup>	1–70 <sup>①</sup>	1–70 <sup>①</sup>	1–70 <sup>①</sup>	1–70 <sup>①</sup>	1–70 <sup>①</sup>	1–70 <sup>①</sup>	0.1–1 <sup>①</sup>
16	16	32	32	16	16	32	32	32	32 x 2
18-point removable terminal block with screws	18-point removable terminal block with screws	40-pin connector	40-pin connector	18-point removable terminal block with screws	Removable terminal block with spring terminals	Compact connector 37-pin D-Sub	37-pin D-sub connector	40-pin connector	40-pin connector x 2
16	16	32	64	16	16	32	32	64	64
0.3–0.75	0.3–0.75	0.088–0.3	0.088–0.3	0.3–0.75	0.3–0.75	0.3	0.088–0.3	0.088–0.3	0.3
50 (all input points ON)	55 (all input points ON)	70 (all input points ON)	85 (all input points ON)	50 (all input points ON)	50 (all input points ON)	75 (all input points ON)	75 (all input points ON)	90 (all input points ON)	90 (all input points ON)
0.13	0.14	0.12	0.13	0.16	0.16	0.16	0.16	0.18	0.18
27.4x98x90	27.4x98x90	27.4x98x90	27.4x98x90	27.4x98x90	27.4x98x90	27.4x98x90	27.4x98x90	27.4x98x90	27.4x98x90
204678	136397	136398	136399	127587	221840	129594	229240	150836	150837

■ Digital output modules

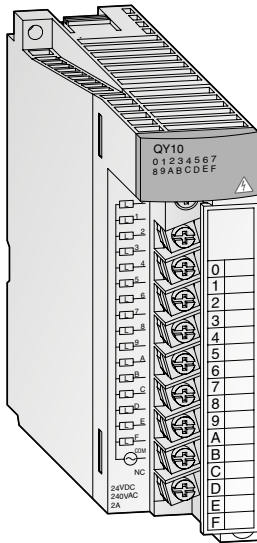

**Adapted output technology**

The MELSEC System Q output modules have different switching elements for adaptation to many control tasks.

**Special features:**

- Output modules with relay, transistor or triac switches
- Potential isolation between process and control by means of an opto-coupler is a standard feature
- Modules with potential isolation between the channels
- Modules with 16 protection points have removable terminal blocks with screws
- Assembled cables are available for modules with D-sub plugs (Q32CBL: 3 m or 5 m; Q40CBL: 3 m or 5 m).
- Different system terminals for simplified cabling and to supplement the performance of the modules are available.
- Response time of 2 μs for high-speed output module QY41H
- The QY68A has 8 independent transistor outputs.

Specifications	QY10	QY10-TS	QY18A	QY22	QY40P	QY40P-TS	QY41H	
Outputs	16	16	8	16	16	16	32	
Output type	Relay	Relay	Relay	Triac	Transistor (sink type)	Transistor (sink type)	Transistor high-speed (sink type)	
Common terminal arrangement points	16	16	8	16	16	16	32	
Insulation method	Relay	Relay	Relay	Photocoupler insulation between output terminals and PC power				
Rated output voltage	24 V DC/240 V AC	24 V DC/240 V AC	24 V DC/240 V AC	100–240 V AC	12/24 V DC	12/24 V DC	5–24 V DC	
Operating voltage range	—	—	—	—	10.2–28.8 V DC	10.2–28.8 V DC	4.25–28.8 V DC	
Min. switching load	5 V DC (1 mA)	5 V DC (1 mA)	5 V DC (1 mA)	24 V AC (100 mA) 100 V AC (25 mA) 240 V AC (25 mA)	—	—	—	
Max. switching voltage	125 V DC/264 V AC	125 V DC/264 V AC	125 V DC/264 V AC	288 V AC	—	—	—	
Max. output current	A 2	2	2	0.6	0.1	0.1	0.2	
Output current per group TYP	A 8	8	8	4.8	1.6	1.6	2	
Inrush current	—	—	—	—	0.7 A for ≤10 ms	0.7 A for ≤10 ms	0.7 A for ≤10 ms	
Leakage current at OFF	mA —	—	—	≤1.5 (120 V AC), ≤3 (240 V AC)	≤0.1	≤0.1	≤0.1	
Response time	OFF → ON	ms ≤10	≤10	≤10	1	≤1	≤1	
	ON → OFF	ms ≤12	≤12	≤12	1	≤1	≤1	
Life	Mechanical	Switching 20 million times			—	—	—	
	Electrical	Switching 100000 times or more			—	—	—	
Max. switching frequency	Switching 3600 times/h			—	—	—	—	
Noise suppression	—	—	—	CR absorber	Zener diode	Zener diode	Zener diode	
Fuse	—	—	—	—	—	—	—	
Power indicator	All modules possess a status LED per output.							
Fuse blown indicator	—	—	—	—	—	—	—	
Connection terminal	18-point removable terminal block with screws	Removable terminal block with spring terminals	18-point removable terminal block with screws	18-point removable terminal block with screws	18-point removable terminal block with screws	Removable terminal block with spring terminals	40-pin connector	
Occupied I/O points	16	16	16	16	16	16	32	
Applicable wire size	mm <sup>2</sup> 0.3–0.75	0.3–0.75	0.3–0.75	0.3–0.75	0.3–0.75	0.3–0.75	0.088–0.3	
Ext. power supply req.	Voltage	—	—	—	—	12–24 V DC	12–24 V DC	
	Current	mA —	—	—	—	10 (24 V DC)	10 (24 V DC)	
Internal power consumption (5 V DC)	mA 430 (all output points ON)	430 (all output points ON)	430 (all output points ON)	250 (all output points ON)	65 (all output points ON)	65 (all output points ON)	370 (all output points ON)	
Weight	kg 0.22	0.22	0.22	0.40	0.16	0.16	0.10	
Dimensions (WxHxD)	mm 27.4x98x90	27.4x98x90	27.4x98x90	27.4x98x112	27.4x98x90	27.4x98x90	27.4x98x90	
<b>Order information</b>	Art. no.	129605	221841	136401	136402	132575	221842	308738
Accessories	37-pin connector, 40-pin connector and ready to use connection cables; spring clamp terminal block for exchange against the standard screw terminal block > refer to chapter 5							

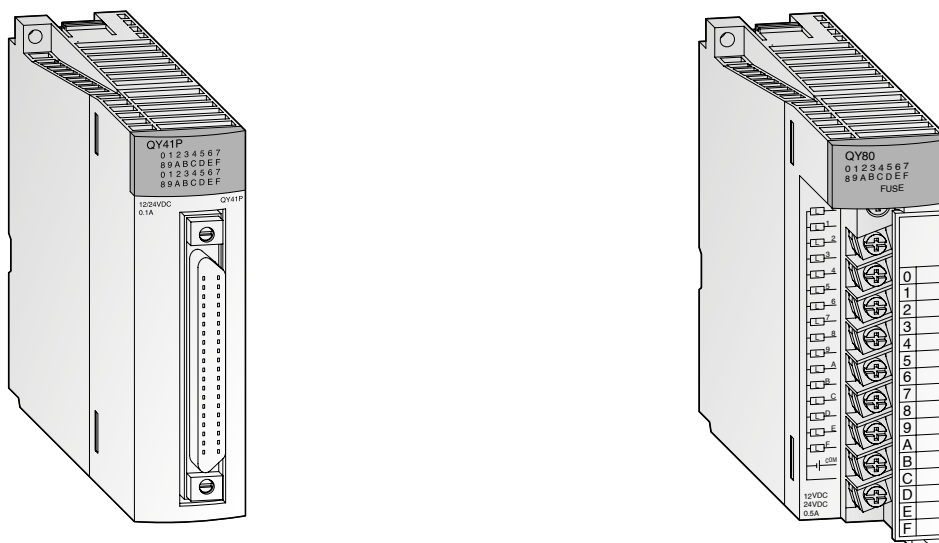

QY41P	QY42P	QY50	QY68A	QY70	QY71	QY80	QY80-TS	QY81P	QY82P
32	64	16	8	16	32	16	16	32	64
Transistor (sink type)	Transistor (sink type)	Transistor (sink type)	Transistor (sink/source type)	Transistor (sink type)	Transistor (sink type)	Transistor (source type)	Transistor (source type)	Transistor (source type)	Transistor (source type)
32	32	16	8	16	32	16	16	32	32
12/24 V DC	12/24 V DC	12/24 V DC	5–24 V DC	5/12 V DC	5/12 V DC	12/24 V DC	12/24 V DC	12/24 V DC	12/24 V DC
10.2–28.8 V DC	10.2–28.8 V DC	10.2–28.8 V DC	4.5–28.8 V DC	4.5–15 V DC	4.5–15 V DC	10.2–28.8 V DC	10.2–28.8 V DC	10.2–28.8 V DC	10.2–28.8 V DC
—	—	—	—	—	—	—	—	—	—
0.1	0.1	0.5	2	0.016	0.016	0.5	0.5	0.1	0.1
2	2	4	—	0.256	0.512	4	4	2	2
0.7 A for ≤10 ms	0.7 A for ≤10 ms	4 A for ≤10 ms	8 A for ≤10 ms	40 mA for ≤10 ms	40 mA for ≤10 ms	4 A for ≤10 ms	4 A for ≤10 ms	0.7 A for ≤10 ms	0.7 A for ≤10 ms
≤0.1	≤0.1	≤0.1	≤0.1	—	—	≤0.1	≤0.1	≤0.1	≤0.1
≤1	≤1	≤1	≤3	≤0.5	≤0.5	1	1	1	≤1
≤1	≤1	≤1	≤10	≤0.5	≤0.5	1	1	1	≤1
—	—	—	—	—	—	—	—	—	—
—	—	—	—	—	—	—	—	—	—
—	—	Zener diode	Zener diode	—	—	Zener diode	Zener diode	Zener diode	Zener diode
Short-circuit proof	Short-circuit proof	6.7 A	—	1.6 A	1.6 A	6.7 A	6.7 A	Short-circuit proof	—
—	—	LED	—	LED	LED	LED	LED	LED	—
40-pin connector	40-pin connector x 2	18-point removable terminal block with screws	18-point removable terminal block with screws	18-point removable terminal block with screws	40-pin connector	18-point removable terminal block with screws	Removable terminal block with spring terminals	Compact connector 37-pin D-Sub	40-pin connector x 2
32	64	16	16	16	32	16	16	32	64
0.3	0.3	0.3–0.75	0.3–0.75	0.3–0.75	0.088–0.3	0.3–0.75	0.3–0.75	0.3	0.3
12–24 V DC	12–24 V DC	12–24 V DC	—	5–12 V DC	5–12 V DC	12–24 V DC	12–24 V DC	12–24 V DC	12–24 V DC
20 (24 V DC)	20 (24 V DC)	20 mA (24 V DC)	—	90 mA (12 V DC)	170 mA (12 V DC)	20 mA (24 V DC)	20 mA (24 V DC)	40 mA (24 V DC)	40 mA (24 V DC)
105 (all output points ON)	150 (all output points ON)	80 (all output points ON)	110 (all output points ON)	95 (all output points ON)	150 (all output points ON)	80 (all output points ON)	80 (all output points ON)	95 (all output points ON)	160 (all output points ON)
0.15	0.17	0.17	0.14	0.14	0.14	0.17	0.17	0.15	0.17
27.4x98x90	27.4x98x90	27.4x98x90	27.4x98x90	27.4x98x90	27.4x98x90	27.4x98x90	27.4x98x90	27.4x98x90	27.4x98x90
132576	132577	132578	136403	136404	136405	127588	221843	129607	242366

■ Analog input modules

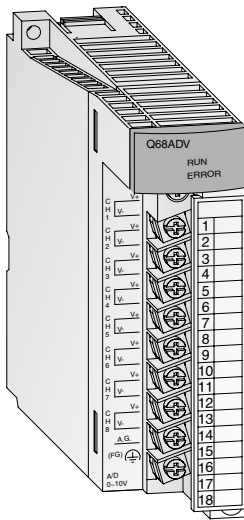

**Detection of analog process signals**

The analog input modules convert analog process signals, for example pressure, flow or fill level, linearly into digital values, which are further processed by the Q CPU.

**Special features:**

- Up to 8 channels per module (Q68AD□) and up to 256 channels per system (Q CPU)
- Resolution of 0.83 mV and 3.33  $\mu$ A (Q64AD)
- Conversion time of 80  $\mu$ s/channel (Q68AD□)
- Calculation of average value over the time or measurement cycles can be configured
- Integrated logging function (Q64ADH)
- Flow amount measurement function (Q64ADH)
- Potential isolation between process and control by means of an optocoupler is a standard feature.
- All modules are provided with a removable terminal block fastened with screws.

Specifications		Q64AD	Q64ADH	Q68ADV	Q68ADI
Input points		4	4	8	8
Analog input		-10 V/10 V (0 mA/20 mA)	-10 V/10 V (0 mA/20 mA)	-10 V/10 V	0 mA/20 mA
Resolution		16 bits binary (incl. sign)		16 bits binary (incl. sign)	16 bits binary (incl. sign)
Load resistance	Voltage	M $\Omega$	1	1	1
	Current	$\Omega$	250	250	250
Max. input	Voltage	V	$\pm 15$	$\pm 15$	$\pm 15$
	Current	mA	$\pm 30$	$\pm 30$	$\pm 30$
I/O characteristics ①	Analog input	-10–10 V	0–20 mA	-10–10 V	0–20 mA
	Digital output	1/4000, 1/12000, 1/16000	1/4000, 1/8000, 1/12000	1/20000, 1/22500	1/4000, 1/12000, 1/16000
Max. resolution	Voltage input	2.5 mV	—	500 $\mu$ V	2.5 mV
		1.25 mV	—	250 $\mu$ V	5 mV
	Current input	0.83 mV	—	219 $\mu$ V	1.25 mV
		—	10 $\mu$ A	200 $\mu$ V	1 mV
		—	5 $\mu$ A	—	—
		—	3.33 $\mu$ A	—	—
		—	1000 nA	—	0–20 mA
		—	878 nA	—	4–20 mA
		—	800 nA	—	—
Overall accuracy		$\pm 0.4\%$ (0–55 °C), $\pm 0.1\%$ (20–30 °C)		$\pm 0.4\%$ (0–55 °C), $\pm 0.1\%$ (20–30 °C)	
Max. conversion time		80 $\mu$ s/channel (+160 $\mu$ s with temperature drift compensation)			
Insulation method		Photocoupler insulation between output terminals and PC power for all modules.			
Occupied I/O points		16	16	16	16
Connection terminal		All modules are fitted with a terminal block with 18 screw terminals.			
External power consumption		Not necessary for any module			
Applicable wire size	mm <sup>2</sup>	0.3–0.75	0.3–0.75	0.3–0.75	0.3–0.75
Internal power consumption (5 V DC)	mA	630	520	640	640
Weight	kg	0.14	0.18	0.19	0.19
Dimensions (WxHxD)	mm	27.4x98x90	27.4x98x90	27.4x98x90	27.4x98x90
<b>Order information</b>	Art. no.	129615	251331	129616	129617

①  $\pm 0.4\%$  (0–55 °C);  $\pm 0.1\%$  (20–30 °C)

## ■ Analog input modules

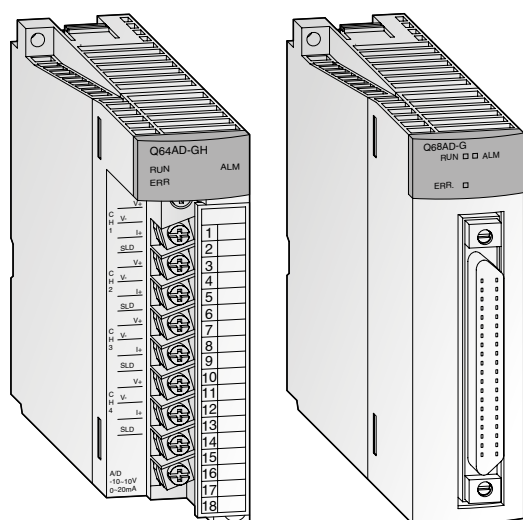

### Channel isolated and high resolution

The analog input modules convert analog process signals into digital values with high accuracy. With the exception of the ME1AD8HAI-Q, all channels are isolated between each other and against the external power supply with high dielectric withstand voltage for both.

The ME1AD8HAI-Q provides a HART master function and can communicate with up to eight HART-enabled devices. The connection of standard analog input devices is also supported.

### Special features:

- Potential isolation between each channel and between process and control is a standard feature.
- High resolution: 16/32 bit signed binary
- High accuracy with a reference accuracy of  $\pm 0.05\%$  and a temperature coefficient of  $\pm 71.4$  ppm/ $^{\circ}\text{C}$
- Integrated short circuit protection by limiting the input current
- Signal conditioning function for the Q62AD-DGH
- Q66AD-DG signal converter
- Power supply for 2-wire transmitter (Q66AD-GD, ME1AD8HAI-Q)
- A primary delay filter smoothes out the line of digital output values by a user-defined time constant
- Terminal block is fastened with screws and removable.

Specifications	Q62AD-DGH	Q64AD-GH	Q66AD-DG	Q68AD-G	ME1AD8HAI-Q	
Input points	2	4	6	8	8	
Analog input	4 mA/20 mA	-10 V/10 V (0 mA/20 mA)	0 mA/4 mA/20 mA	-10 V/10 V (0 mA/20 mA)	0 mA/4 mA/20 mA	
Resolution	16/32 bits binary (incl. sign)	16/32 bits binary (incl. sign)	16 bits binary (incl. sign)	16 bits binary (incl. sign)	16 bits signed binary	
Load resistance	Voltage	MQ	—	—	—	
	Current	$\Omega$	250	250	250	250
Max. input	Voltage	V	$\pm 15$	$\pm 15$	—	
	Current	mA	$\pm 30$	$\pm 30$	$\pm 30$	$\pm 30$
	Analog input	4–20 mA	-10–10 V	0–20 mA	-10–10 V; 0–20 mA	0–20 mA; 4–20 mA
I/O characteristics	Digital output	0–32000 (16 bits) 0–64000 (32 bits)	-32000–32000 (16 bits), -64000–64000 (32 bits), 0–32000 (16 bits), 0–64000 (32 bits)	-96–4095 (16 bits), -288–12287 (16 bits)	-12288–12287 (16 bits), -16384–16383 (16 bits), -32768–32767 (16 bits)	0–32000 (16 bits, 32 bits)
Max. resolution	Voltage input	—	0–10 V: 156.3 $\mu\text{V}$ (32 bits), 312.6 $\mu\text{V}$ (16 bits), 0–5 V: 78.2 $\mu\text{V}$ (32 bits), 156.4 $\mu\text{V}$ (16 bits), 1–5 V: 62.5 $\mu\text{V}$ (32 bits), 125.0 $\mu\text{V}$ (16 bits), -10–10 V: 156.3 $\mu\text{V}$ (32 bits), 312.6 $\mu\text{V}$ (16 bits)	—	0–10 V: 0.625 mV (16 bits), 0–5 V: 0.416 mV (16 bits), 1–5 V: 0.333 mV (16 bits), -10–10 V: 0.625 mV (16 bits), user defined: 0.333 mV (16 bits)	—
	Current input	4–20 mA: 0.25 $\mu\text{A}$ (32 bits), 0.50 $\mu\text{A}$ (16 bits) user defined: 0.151 $\mu\text{A}$ (32 bits), 0.303 $\mu\text{A}$ (16 bits)	0–20 mA: 0.312 $\mu\text{A}$ (32 bits), 0.625 $\mu\text{A}$ (16 bits) 4–20 mA: 0.25 $\mu\text{A}$ (32 bits), 0.50 $\mu\text{A}$ (16 bits) user defined: 0.151 $\mu\text{A}$ (32 bits), 0.303 $\mu\text{A}$ (16 bits)	0–20 mA: 1.66 $\mu\text{A}$ (16 bits) 4–20 mA: 1.33 $\mu\text{A}$ (16 bits) user defined: 1.33 $\mu\text{A}$ (16 bits)	0–20 mA: 1.66 $\mu\text{A}$ (16 bits) 4–20 mA: 1.33 $\mu\text{A}$ (16 bits) user defined: 1.33 $\mu\text{A}$ (16 bits)	0–20 mA: 0.625 $\mu\text{A}$ 4–20 mA: 0.50 $\mu\text{A}$
Overall accuracy	$\pm 0.05\%$	$\pm 0.05\%$	$\pm 0.1\%$	$\pm 0.1\%$	$\pm 0.15\%$	
Temperature coefficient	$\pm 71.4$ ppm/ $^{\circ}\text{C}$ (0.00714 %/ $^{\circ}\text{C}$ )	$\pm 71.4$ ppm/ $^{\circ}\text{C}$ (0.00714 %/ $^{\circ}\text{C}$ )	$\pm 71.4$ ppm/ $^{\circ}\text{C}$ (0.00714 %/ $^{\circ}\text{C}$ )	$\pm 71.4$ ppm/ $^{\circ}\text{C}$ (0.00714 %/ $^{\circ}\text{C}$ )	—	
Max. conversion time	10 ms/2 channels	10 ms/4 channels	10 ms/channel	10 ms/channel	80 ms (channel independent)	
Insulation method	Photocoupler insulation between each channel	Photocoupler insulation between each channel	Transformer insulation between the input channels and between the channels and PLC power	Transformer insulation between the input channels and between the channels and PLC power	Photocoupler insulation between the channels and OLC power; No insulation between analog input channels	
Occupied I/O points	16	16	16	16	32	
Connection terminal	18-point removable terminal block with screws	18-point removable terminal block with screws	40-pin connector at the front	40-pin connector at the front	18-point removable terminal block with screws	
External power consumption	24 V DC, 360 mA	Not necessary	24 V DC, 360 mA	Not necessary	24 V DC, 300 mA	
Applicable wire size	mm <sup>2</sup> 0.3–0.75	0.3–0.75	0.3	0.3	0.51	
Internal power consumption (5 V DC)	mA 220	890	420	460	320	
Weight	kg 0.19	0.20	0.22	0.16	0.19	
Dimensions (WxHxD)	mm 27.4x98x90	27.4x98x90	27.4x102x130	27.4x102x90	27.4x98x90	
Order information	Art. no. 145036	143542	204676	204675	229238	

■ Analog output modules

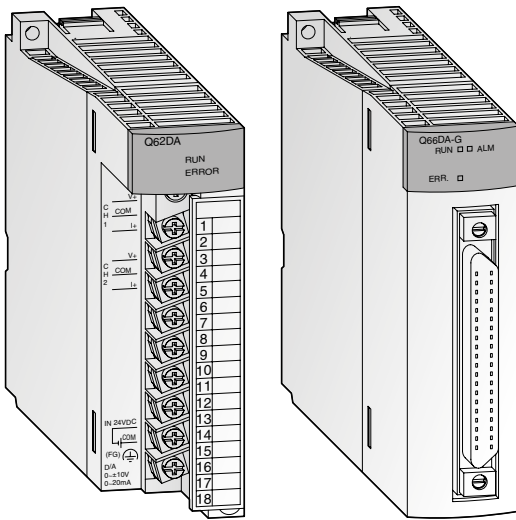

**Output of analog control signals**

The analog output modules convert digital values predetermined by the CPU into an analog current or voltage signal. For example, frequency inverters, valves or slide valves are controlled by means of these signals.

The functionality of a HART Master station is integrated in the ME1DA6HAI-Q. It can communicate with up to 6 HART compatible devices.

**Special features:**

- Up to 8 channels per module (Q68DA□) and up to 256 channels per system
- Resolution of 0.333 mV and 0.83 μA
- Conversion time of 80 μs/channel
- Potential isolation between process and control by means of an opto-coupler is a standard feature. Additional potential isolation between the channels for the Q62DANQ, 62DAN-FGQ, 68DAVN and Q68DAIN.
- Disconnection detection function that monitors the output values by means of re-conversion and limit exceeding function (Q62DAN-FG only)
- The modules are provided with a removable terminal block fastened with screws.

Specifications	Q62DAN	Q62DA-FG	Q64DAN	Q66DA-G	Q68DAVN	Q68DAIN	ME1DA6HAI-Q
Output points	2	2	4	6	8	8	6
Digital input	-4096–4095 -12288–12287 -16384–16383	-4096–4095 -12288–12287 -16384–16383	-4096–4095 -12288–12287 -16384–16383	-4096–4095 -12288–12287 -16384–16383	-4096–4095 -12288–12287 -16384–16383	-4096–4095 -12288–12287 -16384–16383	0–28000 -32768–32767
Analog output	-10–10 V DC (0 mA–20 mA DC)	-10–10 V DC (0 mA–20 mA DC)	-10–10 V DC (0 mA–20 mA DC)	-12–12 V DC (0 mA–22 mA DC)	-10–10 V DC	0 mA–20 mA DC	0/4 mA–20 mA DC
Load resistance	Voltage output	1 kΩ–1 MΩ	1 kΩ–1 MΩ	1 kΩ–1 MΩ	1 kΩ–1 MΩ	—	—
	Current output	0–600 Ω	0–600 Ω	0–600 Ω	0–600 Ω	—	50–600 Ω
Max. outputs	Voltage V	±12	±12	±13	±12	—	—
	Current mA	21	23	21	23	—	21
<b>Voltage output</b> ①							
I/O characteristics	Voltage output	0–5 V	0–5 V	1–5 V	-10–10 V	-10–10 V	user defined
	Digital Input	0–4000	0–12000	0–12000	-4000–4000	-16000–16000	-4000–4000
Max. resolution	1.25 mV	0.416 mV	0.333 mV	2.5 mV	0.625 mV	0.75 mV	—
<b>Current output</b> ②							
I/O characteristics	Current output	0–20 mA	0–20 mA	4–20 mA	4–20 mA	User defined	User defined
	Digital Input	0–4000	0–12000	0–4000	0–12000	-4000–4000	-12000–12000
Max. resolution	5 μA	4 μA	1.66 μA	1.33 μA	1.5 μA	0.83 μA	571 nA
Overall accuracy	± 0.3 % (0–55 °C); ± 0.1 % (20–30 °C)						
Max. conversion time	80 μs/channel	10 ms/2 channels	80 μs/channel	6 ms/channel	80 μs/channel	80 μs/channel	70 ms
Insulation method	Photocoupler insulation between output terminals and PLC power	Each output is photocoupler insulated between each other and against the PLC power	Photocoupler insulation between output terminals and PLC power	Transformer insulation between the output channels and between the channels and PLC power.	Photocoupler insulation between output terminals and PLC power		
Occupied I/O points	16	16	16	16	16	16	32
Connection terminal	18-point removable terminal block with screws			40-pin connector at the front	18-point removable terminal block with screws		
Applicable wire size	mm <sup>2</sup> 0.3–0.75	0.3–0.75	0.3–0.75	0.3	0.3–0.75	0.3–0.75	According to HART specification
Internal power consumption (5 V DC)	mA 330	370	340	620	390	380	320
Weight	kg 0.19	0.20	0.19	0.22	0.18	0.18	0.19
Dimensions (WxHxD)	mm 27.4x98x90	27.4x98x90	27.4x98x90	27.4x102x130	27.4x98x90	27.4x98x90	27.4x98x90
<b>Order information</b>	Art. no. 200689	145037	200690	204677	200691	200692	236649

① Values are valid for all modules except for Q68DAIN;  
 ② Values are valid for all modules except for Q68DAVN



## ■ Combined analog input/output module

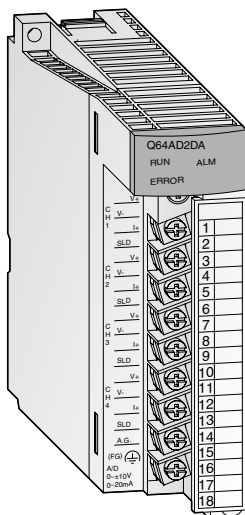

### Q64AD2DA

With the analog input/output module Q64AD2DA the user has a module that has both, four analog inputs and two analog outputs.

Selection of current or voltage input signal is possible for the analog inputs.

#### Special features:

- Detection and output of voltage and current with only one module.
- Detection of analog signals with either standard or high resolution

Specifications		Q64AD2DA	
Input points		4	
Analog input	Voltage	V	-10-10
	Current	mA	0-20
Load resistance	Voltage	MΩ	1
	Current	Ω	250
Max. input	Voltage	V	±15
	Current	mA	±30
I/O characteristics	Analog input	-10-10 V; 0-20 mA	
	Digital output	±1/4000, ±1/16000; ±1/4000, ±1/12000	
Max. resolution	Voltage input	0.333 mV	
	Current input	0.83 μA	
Accuracy	±0.4 % (0-55 °C), ±0.1 % (20-30 °C)		
Max. conversion time	500 μs/channel		
Output points	2		
Digital input	-16384-16383		
Analog output	Voltage	V	-10-10
	Current	mA	0-20
Load resistance	Voltage output	1 kΩ-1 MΩ	
	Current output	0-600 Ω	
Max. output	Voltage	V	±12
	Current	mA	21
I/O characteristics	Analog output	-10-10 V; 0-20 mA	
	Digital input	±1/4000, ±1/16000; ±1/4000, ±1/12000;	
Max. resolution	Voltage output	0.333 mV	
	Current output	1.33 μA	
Accuracy	±0.3 % (0-55 °C), ±0.1 % (20-30 °C)		
Max. conversion time	500 μs/channel		
Connection terminal	18-point removable terminal block with screws		
Occupied I/O points	16		
Dimensions (WxHxD)	mm	27.4x98x90	
Order information		Art. no.	229238

■ Analog modules for temperature measurement

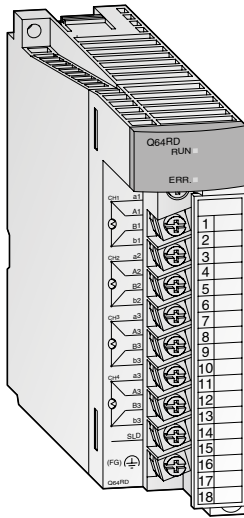

Temperature measurement by temperature sensors

These modules are designed to convert external platinum temperature-measuring resistor input values into 16 or 32-bit signed binary temperature measurement values and scaling values.

The reference temperature is determined by means of a Pt100 resistance thermometer for the Q64RD module (Q64RD-G additionally with Ni100 resistors) and by means of a thermocouple for the Q64TD and Q64TDV-GH modules.

Special features:

- Temperature of 4 channels can be measured by one module
- Two kinds of platinum temperature measuring resistors compliant with the JIS, IEC and DIN standards are supported.
- The disconnection of a platinum temperature-measuring resistor or cable can be detected on each channel
- Selection of sampling processing/time averaging processing/count averaging processing
- Error compensation by offset/gain value setting
- Alarm output when limit value is exceeded
- Potential isolation between process and control by means of an optocoupler is a standard feature. Additional potential isolation between the channels for Q64TDV-GH and Q64RD-G.
- Removable terminal block fastened with screws.

Specifications	Q64RD	Q64RD-G	Q64TD	Q64TDV-GH	Q68RD3-G	Q68TD-G-H01/H02
Input channels	4	4	4	4	8	8
Connectable temperature sensors type	Pt100 (conforms to JIS C 1604-1989 and DIN IEC 751), JPt100 (conforms to JIS C 1604-1981)	Pt100 (conforms to JIS C 1604-1997 and DIN IEC 751-1983), JPt100 (conforms to JIS C 1604-1981), Ni100Ω (conforms to DIN 43760-1987)	K, E, J, T, B, R, S, N (conforms to JIS C 1602-1995, IEC 584-1 and 584-2)	K, E, J, T, B, R, S, N (conforms to JIS C 1602-1995, IEC 584-1 and 584-2)	Pt100 (conforms to JIS C 1604-1997 and DIN IEC 751), JPt100 (conforms to JIS C 1604-1981), Ni100Ω (conforms to DIN 43760-1987)	K, E, J, T, B, R, S, N (conforms to JIS C 1602-1995, IEC 584-1 and 584-2)
Temperature measuring range	Pt100: -200–850 °C, JPt 100: -180–600 °C	Pt100: -200–850 °C, JPt100: -180–600 °C, Ni100 Ω: -60–180 °C	Depends on the thermocouple used	Depends on the thermocouple used	Pt100: -200–850 °C, JPt100: -180–600 °C, Ni100Ω: -60–180 °C	Depends on the thermocouple used
Temperature scaling value	16-bit, signed binary: -2000–8500 32-bit, signed binary: -200 000–850 000	16-bit, signed binary: -2000–8500 32-bit, signed binary: -200 000–850 000	16-bit, signed binary: -2700–18 200 32-bit, signed binary: —	16-bit, signed binary: -25 000–25 000 32-bit, signed binary: —	16-bit, signed binary: -2000–8500	16-bit, signed binary: -2700–18 200
Max. resolution °C	0.025 °C	0.025 °C	B, R, S, N: 0.3 °C; K, E, J, T: 0.1 °C	B: 0.7 °C; R, S: 0.8 °C; K, T: 0.3 °C; E: 0.2 °C; J: 0.1 °C; N: 0.4 °C; Voltage: 4 μV	0.1 °C	B, R, S, N: 0.3 °C; K, E, J, T: 0.1 °C
Cold junction temp. compensation accuracy	—	—	±1.0 °C	±1.0 °C	—	provided
Overall accuracy	±0.08 % (accuracy relative to full-scale value) at ambient temperature 25±5 °C	±0.04 % (accuracy relative to full-scale value) at ambient temperature 25±5 °C	Depends on the thermocouple used	Depends on the thermocouple used	Depends on the thermocouple used	Depends on the thermocouple used
Max. conversion time	40 ms/channel	40 ms/channel	20 ms/channel	20 ms/channel	320 ms/8 channels	320 ms/8 channels (H01), 640 ms/8 channels (H02)
Analog inputs	4 channels/module	4 channels/module	4 channels/module + Pt100 connection	4 channels/module + Pt100 connection	8 channels	8 channels/module
Temp. measurement output current mA	1	1	—	—	1	—
Insulation method	Transformer insulation ①	Photocoupler insulation ② Transformer insulation ③	Transformer insulation ④	Transformer insulation ⑤	Transformer insulation ⑤	Transformer insulation ⑤
Disconnection detection	For each channel independent					
Occupied I/O points	16	16	16	16	16	16
Connection terminal	All modules are fitted with a removable terminal block with 18 screw terminals.				A6CON 40pin connector	
Applicable wire size mm <sup>2</sup>	0.3–0.75	0.3–0.75	0.3–0.75	0.3–0.75	≤0.3	≤0.3
Internal power consumption (5 V DC) mA	600	620	500	500	0.54 A	0.49 A (H01) 0.65 A (H02)
Weight kg	0.17	0.20	0.25	0.25	0.20	0.17
Dimensions (WxHxD) mm	27.4x98x90	27.4x98x112	27.4x98x90	27.4x98x90	27.4x102x130	27.4x98x90 (H01) 27.4x102x130 (H02)
<b>Order information</b>	Art. no. 137592	154749	137591	143544	216482	216481/221582

① between power supply and temperature inputs    ② between each channel and PLC power    ③ between measuring input channels  
④ between thermocouple inputs as well as thermocouple and earth    ⑤ between each channel and between the channels and PLC power

## Temperature control modules

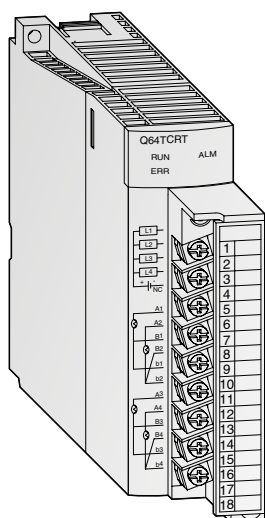

### Temperature control modules with PID algorithm

These modules enable PID algorithm temperature control without placing any load on the PLC CPU for the temperature control tasks.

#### Special features:

- Four temperature input channels
- Auto-tuning function for the 4 PID control circuits
- Temperature control can continue even when the PLC program is stopped
- Transistor output with pulse train to drive the actuator in the control circuit
- The module is provided with a removable terminal block fastened with screws.

Specifications		Q64TCRTN	Q64TCRTBWN	Q64TCTTN	Q64TCTTBWN
Control output	type	Transistor	Transistor	Transistor	Transistor
Inputs		4 channels per module	4 channels per module/ broken wire detection	4 channels per module	4 channels per module/ broken wire detection
Supported temperature sensors		Pt100 (-200–600 °C), JPt100 (-200–500 °C)		R, K, J, T, S, B, E, N, U, L, P L II, W5Re/W26Re	
Sampling cycle		0.5 s/4 channels	0.5 s/4 channels	0.5 s/4 channels	0.5 s/4 channels
Control output cycle	s	1–100	1–100	1–100	1–100
Input filter		1–100 s (0 s: input filter OFF)	1–100 s (0 s: input filter OFF)	1–100 s (0 s: input filter OFF)	1–100 s (0 s: input filter OFF)
Temperature control method		PID ON/OFF impulse or 2-position control		PID ON/OFF impulse or 2-position control	
PID constant range	PID constant setting	Setting with automatic tuning possible		Setting with automatic tuning possible	
	Proportional band P	0.0–1000 % (0 %: 2-position control)		0.0–1000 % (0 %: 2-position control)	
	Integral time I	1–3600 s	1–3600 s	1–3600 s	1–3600 s
	Differential time D	1–3600 s (0 setting for PID control)	1–3600 s (0 setting for PID control)	1–3600 s (0 setting for PID control)	1–3600 s (0 setting for PID control)
Target value setting range		Within the temperature range of the Pt100 sensor used		Within the temperature range of the thermocouple used	
Dead band setting range		0.1–10.0 %	0.1–10.0 %	0.1–10.0 %	0.1–10.0 %
Transistor output	Output signal (sink)	ON/OFF pulse	ON/OFF pulse	ON/OFF pulse	ON/OFF pulse
	Rated load voltage	10–30 V DC	10–30 V DC	10.2–30 V DC	10.2–30 V DC
	Max. load current	0.1 A/1 point, 0.4 A/common	0.1 A/1 point, 0.4 A/common	0.1 A/1 point, 0.4 A/common	0.1 A/1 point, 0.4 A/common
	Max. rush current	400 mA for 10 ms	400 mA for 10 ms	400 mA for 10 ms	400 mA for 10 ms
	Max. voltage drop when ON	0.1 V DC (TYP) 0.1 A 2.5 V DC (MAX) 0.1 A	0.1 V DC (TYP) 0.1 A 2.5 V DC (MAX) 0.1 A	0.1 V DC (TYP) 0.1 A 2.5 V DC (MAX) 0.1 A	0.1 V DC (TYP) 0.1 A 2.5 V DC (MAX) 0.1 A
Response time	OFF → ON: <2 ms ON → OFF: <2 ms	OFF → ON: <2 ms ON → OFF: <2 ms	OFF → ON: <2 ms ON → OFF: <2 ms	OFF → ON: <2 ms ON → OFF: <2 ms	
Insulation method		Transformer	Transformer	Transformer	Transformer
Occupied I/O points		16/1 slot	32/2 slots	16/1 slot	32/2 slots
Connection terminals		All modules are fitted with a terminal block with 18 screw terminals.			
Applicable wire size	mm <sup>2</sup>	0.3–0.75	0.3–0.75	0.3–0.75	0.3–0.75
Internal power consumption (5 V DC)	mA	550	60	550	640
Weight	kg	0.2	0.3	0.2	0.3
Dimensions (WxHxD)	mm	27.4x98x90	27.4x98x90	27.4x98x90	27.4x98x90
Order information	Art. no.	136386	136387	136388	136389

## ■ Load cell input module

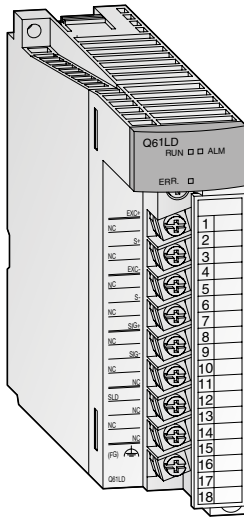

### The load cell input module Q61LD can connect load cells

directly to MELSEC Q series programmable controllers. External signal converters are no longer required.

#### Special features:

- An external signal converter is not required. Man-hours and costs are reduced by using a load cell input module that can be connected directly to a programmable controller.
- The module achieves a highly accurate measurement with steady data conversion speed that guarantees the accuracy of load cells.
- Enhanced convenience with functions like zero offset, two-point calibration and input signal error detection.

Specifications	Q61LD
Analog input (load cell output) points	1
Analog input (load cell output)	mV/V 0.0–3.3
Analog input range (load cell rated output)	mV/V 0.0–1.0 0.0–2.0 0.0–3.0
Load cell applied voltage	5 V DC $\pm 5\%$ , Output current within 60 mA (Four 350 $\Omega$ load cells can be connected in parallel.) 6-wire system (Combination use of remote sensing method and ratiometric method) or 4-wire system
Digital output	32-bit signed binary, 0–10 000
Gross weight output (Max. weighing output value)	32-bit signed binary, -99999–99999 (Excluding decimal point and unit symbol)
Zero adjustment range	mV/V 0.0–3.0
Gain adjustment range	mV/V 0.3–3.2
Resolution	0–10 000
Accuracy	Nonlinearity: within $\pm 0.01\%$ /FS (Ambient temperature: 25 °C)
Conversion speed	ms 10
Insulation method	Photocoupler insulation
Occupied I/O points	16
External connection system	18-point removable terminal block with screws
Applicable wire size	mm <sup>2</sup> 0.3–0.75
Internal power consumption (5 V DC)	A 0.48
Weight	kg 0.17
Dimensions (WxHxD)	mm 27.4x98x90
<b>Order information</b>	Art. no. 229237

## ■ Analog CT input module

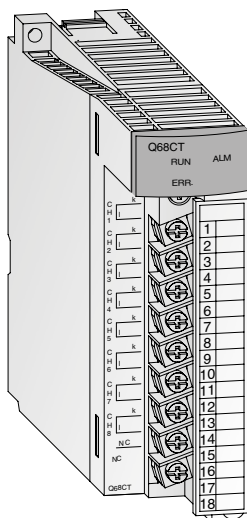

### Current transformer module

Up to eight current transformers can be connected directly to the analog CT input module Q68CT. External signal converters are not required anymore.

#### Special features:

- CT sensors from 5 A AC to 600 A AC are connectable.
- High accuracy within  $\pm 0.5\%$
- Averaging calculation
- Maximum value/minimum value hold function
- Integrated scaling function
- Input signal monitoring with alarm output
- Peak current detection
- Integrated logging function

Specifications		Q68CT
Input points		8
Analog input (via CT sensor)		5/50/100/200/400/600 A AC
Input frequency		50/60 Hz
Excessive input		200 % for 1 minute, 150 % continuously
Digital output	Converted current value	0–10000 (12000)
	Scaling value	–32768–32767
Max. resolution		0–5 A AC : 0.5 mA 0–50 A AC : 5 mA 0–100 A AC : 10 mA 0–200 A AC : 20 mA 0–400 A AC : 40 mA 0–600 A AC : 60 mA
Overall accuracy		$\pm 0.5\%$
Minimum sampling cycle		10 ms/8 channels
Response time		Max. 0.4 s
Insulation method		Between input terminals and power supply: transformer. Between input channels: no isolation
Occupied I/O points		16
External connection system		18-point removable terminal block with screws
Applicable wire size	mm <sup>2</sup>	0.3–0.75
Internal power consumption (5 V DC)	mA	350
Weight	kg	0.19
Dimensions (WxHxD)	mm	27.4x98x112
Order information	Art. no.	145036

## ■ Loop control module

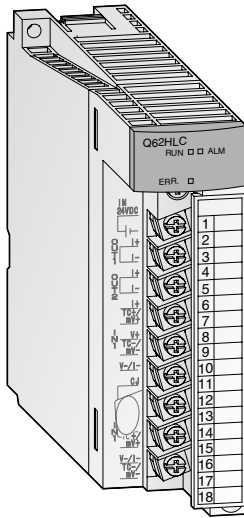

### For fast response control

The Q62HLC loop control module uses a continuous proportional PID control format, which features a sampling period of 25 ms for high-accuracy, high-resolution thermocouple inputs, microvoltage inputs, voltage inputs, current inputs and current outputs. These features make the Q62HLC ideal for applications such as rapid temperature increase control, prepressure control and flow rate control.

### Special features:

- Staggering 25 ms sampling and control update time make the Q62HLC to one of the fastest control module in the market
- Supports sensor types, such as thermocouple, microvoltage, voltage and current input range
- Continuous proportional PID control by 4 to 20 mA current output results in highly stable and accurate control
- Control program profiles can be specified where set values and PID constants are automatically changed at specific times.
- Cascade control can be performed with channel 1 as the master and channel 2 as the slave.

Specifications		Q62HLC	
Number of input channels		2	
Analog input	Thermocouple	°C	-200–2300 (0.1 °C resolution)
	Micro voltage	mV	-100–100 (0.5–10 µV resolution)
	Voltage	V	-10–10 (0.05–1 mV resolution)
	Current	mA	0–20 (0.8–1 µA resolution)
Digital output		-2000–23000, -10000–10000, -10000–10000, 0–20000	
Supported thermocouples		K, J, T, S, R, N, E, B, PL II, W5re/W26Re	
Max. conversion speed		25 ms/2 channels	
Normal mode rejection ratio		60 dB or more (50/60 Hz)	
Common mode rejection ratio		120 dB or more (50/60 Hz)	
Input filter (primary delay digital filter)		0.0–100.0 s	
Sensor compensation value setting		-50.00–50.00 %	
Control method		Continuous proportional control	
PID constant range	PID constant setting	Setting possible by auto-tuning	
	Proportional band (P)	Thermocouple: 0.1 to full scale °C; micro voltage, voltage, current: 0.1–1000.0 %	
	Integral time (I)	s	0.0–3276.7
	Differential time (D)	s	0.0–3276.7
Set value setting range		Thermocouple: input range of thermocouple being used	
Dead band setting range		0.1–10.0 %	
Occupied I/O points		16	
Isolation		Transformer isolation between the input channels and between the inputs and ground	
Connection terminals		18-point removable terminal block with screws	
Applicable wire size	mm <sup>2</sup>	0.3–0.75	
External power supply		24 V DC, 70 mA	
Internal power consumption (5 V DC)		mA	270
Weight		kg	0.25
Dimensions (WxHxD)		mm	27.4x98x112
<b>Order information</b>		Art. no.	200693

## High-speed counter modules

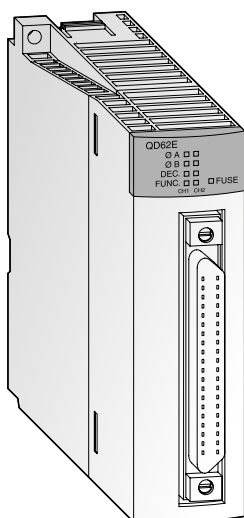

### High-speed counter with automatic detection of rotation direction

These counter modules detect signals with a frequency which cannot be detected by normal input modules. For example, simple positioning tasks or frequency measurements can be realized.

#### Special features:

- Input for incremental shaft encoder with automatic forward and reverse detection
- Preset count via external signals or the PLC program with the aid of the PRESET function
- Ring counter function for counting up to a predefined value with automatic resetting to the starting value
- Functions such as speed measurement, definition of switching points or periodic counting are available.
- The modules QD62□ are provided with a 40-pin connector interface (for suitable connectors, please refer to the chapter "Accessories").
- The module QD60P8-G is provided with a removable terminal block fastened with screws.
- With the QD64D2, counting at the maximum counting speed of 4 Mpps is possible.

Specifications	QD62E	QD62	QD62D	QD60P8-G	QD63P6	QD64D2
Counter inputs	2	2	2	8	6	2
Signal levels	5/12/24 V DC (2–5 mA)	5/12/24 V DC (2–5 mA)	5/12/24 V DC (2–5 mA) (RS422A)	5/12/24 V DC	5 V DC (6.4–11.5 mA)	EIA standards RS422-A (differential line driver),
Max. counting frequency	kHz 200	200	500 (differential)	30	200	4000
Max. counting speed	1-phase-input kHz 200 or 100	200 or 100	500 or 200	30	200, 100 or 10	2000
	2-phase-input kHz 200 or 100	200 or 100	500 or 200	—	200, 100 or 10	4000
Counting range	32 bits + sign (binary), -2147483648–2147483647	32 bits + sign (binary), -2147483648–2147483647	32 bits + sign (binary), -2147483648–2147483647	16 bits binary: 0–32767 32 bits binary: 0–99999999 32 bits binary: 0–2147483647	32 bits + sign (binary), -2147483648–2147483647	32 bits + sign (binary), -2147483648–2147483647
Counter type	All modules are equipped with UP/DOWN preset counter and ring counter function.			Moving average function, alarm output and pre-scale function	UP/DOWN preset counter and ring counter function	Addition method, subtraction method, linear counter format, ring counter format, preset counter function, latch counter function
Comparison range	32 bits + sign (binary)	32 bits + sign (binary)	32 bits + sign (binary)	32 bits + sign (binary)	32 bits + sign (binary)	32 bits + sign (binary)
External digital input points	Preset, function start					
	Nominal values	5/12/24 V DC (2–5 mA)	5/12/24 V DC (2–5 mA)	5/12/24 V DC (2–5 mA) (RS422A)	5/12/24 V DC	4.5–5.5 V/6.4–11.5 mA
External digital output points (coincidence signal)	2 points/channel 12/24 V DC 0.1 A/point, 0.4 A/common (source)	2 points/channel 12/24 V DC 0.5 A/point, 2.0 A/common (sink)	2 points/channel 12/24 V DC 0.5 A/point, 2.0 A/common (sink)	—	—	2 points/channel 12/24 V DC 0.5 A/point, 2.0 A/common (sink)
Occupied I/O points	16	16	16	32	32	32
Connection terminal	40-pin connector at the front	40-pin connector at the front	40-pin connector at the front	18-point removable terminal block with screws	40-pin connector	40-pin connector
Applicable wire size	mm <sup>2</sup> 0.3	0.3	0.3	0.3 – 0.75	0.3	0.3
Internal power consumption (5 V DC)	mA 330	300	380	580	590	530
Weight	kg 0.12	0.11	0.12	0.17	0.15	0.16
Dimensions (WxHxD)	mm 27.4x98x90	27.4x98x90	27.4x98x90	27.4x98x90	27.4x98x90	27.4x98x90
<b>Order information</b>	Art. no. 128949	132579	132580	145038	213229	278855
Accessories	40-pin connector and ready to use connection cables > refer to chapter 5					

## Multi-function counter/timer module

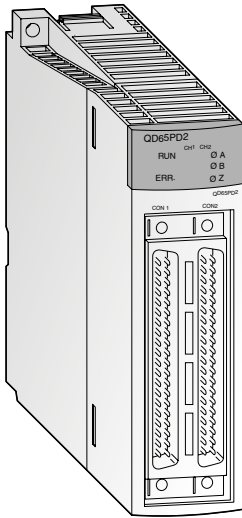

### High-speed counter/timer module with cam switch function

Due to its high-speed counter inputs, PWM outputs for control DC drives and the integrated cam switching function, the QD65PD2 is well suited for high precision positioning tasks.

#### Special features:

- Max. counting speed up to 8 MHz
- Pulse measurement function with a resolution of 100 ns
- Precisely control PWM output up to 200 kHz
- The integrated cam switch function reduces the programming effort
- Integrated digital I/Os
- Connection via two 40-pin plug-in connectors with screws

Specifications		QD65PD2
Counter inputs		2
Signal levels	DC input	5/12/24 V DC (7–10 mA)
	Differential input	Conforms to RS422A
Max. counting frequency	DC input	kHz 200
	Differential input	kHz 8000
Counting range		32 bits + sign (binary), -2147483648–2147483647
External digital input points		6 phase Z inputs; function start and preset count 6 general purpose inputs
External digital output points		8 coincidence outputs, which are activated by comparison of the count value with the user range 8 general purpose outputs
Cam switch	Integrated outputs	8
	Program cycle period	1 ms
PWM outputs	Output frequency	DC to 200 kHz
	Duty ratio	Any ratio can be set (resolution: 0.1 μs)
Dimensions (WxHxD)	mm	27.4x98x90
<b>Order information</b>		Art. no. 245113



## ■ Positioning modules

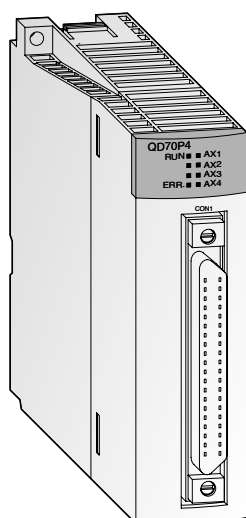

### Multi-axis positioning

The modules are especially designed for systems including multiple axes that do not require any extensive control. The QD70P4 controls up to 4 axes and the QD70P8 up to 8 axes. Since any number of positioning modules can be used the number of axes to be controlled as well is unlimited.

### Special features:

- Control of 4 or 8 axes by one module and more than 8 axes by using multiple modules
- Quick start of up to 8 axes simultaneously (0.1 ms per axis after start command from the CPU)
- Various positioning control systems are selectable.
- Easy parametrizing and positional data setup via optionally available positioning software GX Configurator-PT

Specifications		QD70P4	QD70P8
Number of control axes		4	8
Interpolation		—	
Points per axis		10 (by PLC program or with the positioning software GX Configurator PT)	
Output signal		Pulse chain	
Output frequency		kHz 1–200 000	
Positioning method		PTP positioning; speed/locus positioning; path control	
Positioning	Units	Absolute data: -2 147 483 648–2 147 483 647 pulse Incremental method: -2 147 483 648–2 147 483 647 pulse Speed/position switching control: 0–2 147 483 647 pulse	
	Speed	0–200 000 pulse/s	
	Acceleration/ deceleration processing	Automatic, acceleration and deceleration step by step	
	Acceleration and deceleration time	0–32767 ms	
Pulse output type		Open collector output	
Max. servo motor cable length		m 2	2
Occupied I/O points		32	32
Applicable wire size		0.3 mm <sup>2</sup> (with connector A6CON1); 0.2 mm <sup>2</sup> (with connector A6CON2)	
Internal power consumption (5 V DC)		mA 550	740
External power consumption (24 V DC)		mA 65	120
Weight		kg 0.15	0.17
Dimensions (WxHxD)		mm 27.4x98x90	27.4x98x90
<b>Order information</b>		Art. no. 138328	138329
Accessories		40-pin connector and ready to use connection cables > refer to chapter 5	

■ Positioning modules

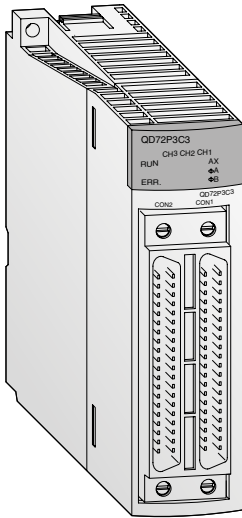

**Space efficient positioning**

The QD72P3C3 and QD73A1 realize positioning applications with less space requirements.

**Special features:**

- Minimized space requirement!
- The QD72P3C3 enables the positioning of 3 axes and has 3 integrated counter inputs
- QD73A1 with integrated D/A converter to control servo amplifiers with analog input
- Optimum solution for specific applications!
- Positioning can be controlled by confirming actual movement amount from encoder inputs.

Specifications		QD72P3C3	QD73A1
Number of control axes		3	1
Interpolation		—	—
Positioning	Data items	1 per axis	1
	Method	PTP control: absolute data and/or incremental	PTP control: absolute or incremental; speed/position swithcing control: incremental
	Control range	-1073741824–1073741823 pulses	-2147483648–2147483647 pulses (32 bit signed binary)
	Speed	0–100 000 pulse/s	1–4000000 pulse/s
	Acceleration/ deceleration processing	Acceleration and deceleration step by step	Automatic, acceleration and deceleration step by step
	Acceleration and deceleration time	ms 1–5000	2–9999
	Start time	Positioning control, speed control: 1 ms	1.2 ms
	Pulse output method	Open collector output	Analog output (0–±10 V DC, adjustable to ±5–±10 V DC)
Max. output pulse	kpps 100	—	
Counter function	Number of channels	3	1
	Count input signal	1-phase input, 2-phase input; 5–24 V DC	2-phase input
	Counting speed	kpps 100	1000
	Counting range	31-bit signed binary (-1073741824–1073741823)	—
External connection		40-pin connector	15-pin and 9-pin connector
Internal power consumption (5 V DC)		A 0.57	0.52
Occupied I/O points		32	48
Weight		kg 0.15	0.2
Dimensions (WxHxD)		mm 27.4x98x90	55.2x98x90
<b>Order information</b>		Art. no. 213230	257759
Accessories		40-pin connector and ready to use connection cables > refer to chapter 5	

## ■ Positioning modules

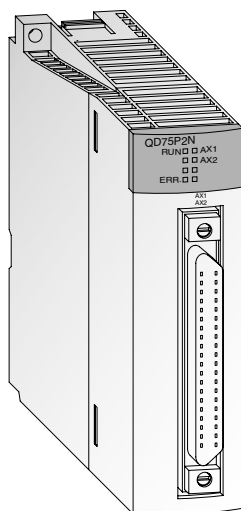

### Positioning with an open control loop

The modules generate the travel command via a pulse chain. The speed is proportional to the pulse frequency and the distance travelled is proportional to the pulse length.

### Special features:

- Control of up to four axes with linear interpolation or circular interpolation
- Storage of up to 600 positional data in the flash ROM (no back-up battery necessary)
- Units of travel can be defined in pulses, mm, inches or degrees.
- Configuration and presetting of all 600 positional data is performed via the PLC program or with the aid of the programming software GX Configurator QP. This software runs under Windows® 95/98 and Windows® 2000/NT.

Specifications	QD75P1N	QD75P2N	QD75P4N
Number of control axes	1	2	4
Interpolation	—	2 axis linear and circular interpolation	2, 3, or 4 axis linear and 2 axis circular interpolation
Points per axis	600 pieces of data with PLC program, 100 pieces of data with GX Configurator QP		
Output type	Open collector	Open collector	Open collector
Output signal	Pulse chain	Pulse chain	Pulse chain
Output frequency	kHz	max. 4000	max. 4000
Positioning	Method	PTP (Point To Point) control, path control (all of linear, circular, and helical can be set), speed control, speed-position switching control, position-speed switching control	
	Units	Absolute data: -2 147 483 648–2 147 483 647 pulse -21 4748 364.8–214 748 364.7 μm -21 474.83648–21 474.83647 inch 0–359.99999 degree  Incremental method: -2 147 483 648–2 147 483 647 pulse -214 748 364.8–214 748 364.7 μm -21 474.83648–21 474.83647 inch -21 474.83648–21 474.83647 degree  Speed/position switching control: 0–2 147 483 647 pulse 0–21 4748 364.7 μm 0–21 474.83647 inch 0–21 474.83647 degree	
	Speed	1 –1 000 000 pulse/s 0.01 –20 000 000.00 mm/min 0.001–200 000.000 degree/min 0.001–200 000.000 inch/min	
	Acceleration/deceleration processing	Automatic trapezoidal acceleration/deceleration, S-pattern acceleration/deceleration	
	Acceleration and deceleration time	1–8388608 ms (4 patterns each can be set)	
	Rapid stop deceleration time	1–8388608 ms	1–8388608 ms
Max. length for servo motor cable	m	10	10
Occupied I/O points	32	32	32
Internal power consumption (5 V DC)	mA	290	360
Weight	kg	0.14	0.16
Dimensions (WxHxD)	mm	27.4x98x90	27.4x98x90
Order information	Art. no.	248389	248390
Accessories	40-pin connector and ready to use connection cables > refer to chapter 5; Programming software: GX Configurator QP, art. no.: 132219		

■ Positioning modules

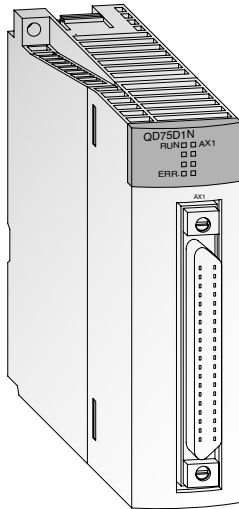

**Long distance positioning**

The modules of the QD75 series are suitable for bridging long distances between module and drive system.

The modules QD75D provide differential outputs.

**Special features:**

- Control of up to four axes with linear interpolation (QD75D4) or two axes circular interpolation (all modules except QD75D1)
- Storage of up to 600 positional data in the flash ROM (no back-up battery necessary)
- Units of travel can be defined in pulses, mm, inches or degrees.
- Configuration and presetting of all 600 positional data is performed via the PLC program or with the aid of the programming software GX Configurator QP.

3 MELSEC System Q

Specifications		QD75D1N	QD75D2N	QD75D4N
Number of control axes		1	2	4
Interpolation		—	2 axis linear and circular interpolation	2, 3, or 4 axis linear and 2 axis circular interpolation
Points per axis		600 pieces of data with PLC program, 100 pieces of data with GX Configurator QP		
Output type		Differential driver	Differential driver	Differential driver
Output signal		Pulse chain	Pulse chain	Pulse chain
Output frequency	kHz	max. 4000	max. 4000	max. 4000
Positioning	Method	PTP control: absolute data and/or incremental; speed/position switching control: incremental; locus/speed control: incremental; path control: absolute data and/or incremental		
	Units	Absolute data: -2 147 483 648–2 147 483 647 pulse -21 4748 364.8–214 748 364.7 μm -21 474.83648–21 474.83647 inch 0–359.99999 degree  Inkremental method: -2 147 483 648–2 147 483 647 pulse -214 748 364.8–214 748 364.7 μm -21 474.83648–21 474.83647 inch -21 474.83648–21 474.83647 degree		
	Speed	Speed/position switching control: 0–2 147 483 647 pulse 0–21 4748 364.7 μm 0–21 474.83647 inch 0–21 474.83647 degree		
	Acceleration/ deceleration processing	Automatic trapezoidal or S-pattern acceleration and deceleration or automatic S-pattern acceleration and deceleration		
	Acceleration and deceleration time	1–8388608 ms (4 patterns, each can be set)		
	Rapid stop deceleration time	1–8388608 ms		
Max. length for servo motor cable	m	10	10	10
Occupied I/O points		32	32	32
Internal power consumption (5 V DC)	mA	430	450	660
Weight	kg	0.15	0.15	0.16
Dimensions (WxHxD)	mm	27.4x98x90	27.4x98x90	27.4x98x90
<b>Order information</b>	Art. no.	248392	248393	248394
Accessories		40-pin connector and ready to use connection cables > refer to chapter 5; Programming software: GX Configurator QP, art. no.: 132219		

## Simple Motion modules

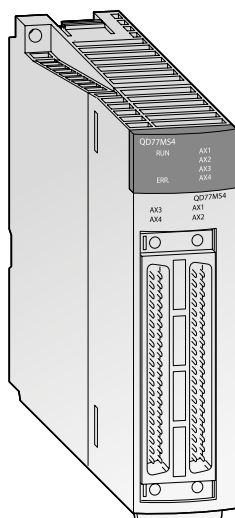

### Advanced control but simple use as the positioning module

The MELSEC System Q lineup includes Simple Motion modules in addition to the regular positioning modules. Various control functions previously only possible with Motion Controllers, such as speed control, torque control, synchronous control and cam control, are now available with the Simple Motion modules.

These functions can be realized with simple parameter adjustments and via the PLC program.

### Special features:

- Various position control modes
- Home position return control
- Advanced synchronous control
- Mark detection
- Speed-torque control (press-fit control)
- Manual control (JOG, inching, or manual pulse generator operation)
- Connection to CC-Link IE Field reduces wiring for QD77GF

Specifications	QD77GF4	QD77GF8	QD77GF16	QD77MS2	QD77MS4	QD77MS16	
Number of controllable axes	4	8	16	2	4	16	
Interpolation functions	Linear interpolation for up to 4 axes, circular interpolation for 2 axes			2 axes linear and circular interpolation	Linear interpolation for up to 4 axes, circular interpolation for 2 axes		
Servo amplifier network	CC-Link IE Field	CC-Link IE Field	CC-Link IE Field	SSCNETIII/H	SSCNETIII/H	SSCNETIII/H	
Servo amplifier	MR-J4-GF(-RJ)			MR-JE-B/MR-J4(W2/W3)-B over SSCNETIII/H			
Operation cycle	ms	0.888	0.888	0.888	0.888	0.888	
Positioning	Method	PTP (Point To Point) control, path control (linear and arc), speed control, speed-position switching control, synchronous control, cam control					
	Acceleration/deceleration control	Trapezoidal acceleration/deceleration, S-curve acceleration/deceleration					
	Compensation	Backlash compensation, electronic gear, near pass function					
Number of positioning points	600 data/axis (All the data points can be set with the buffer memory.)			600 per axis (can be set with GX Works3 or PLC program)			
External input signals	External devices, like encoder or remote I/O are connected via CC-Link IE Field			1 encoder, A/B phase; 4 digital inputs [DI1–DI4]			
Cam function	Storage area cam data	256 kBytes					
	Number of cams	max. 256 (depends on resolution)					
	Resolution per cycle	256/512/1024/2048/4096/8192/16384/32768					
	Stroke resolution	-214.7483648 to 214.7483647 (%)					
Occupied I/O points	32	32	32	32	32	32	
Connection terminal	26-pin connector	26-pin connector	26-pin connector	40-pin connector	40-pin connector	40-pin connector	
No. of Simple Motion modules in one system	max. 8	max. 8	max. 8	max. 8	max. 8	max. 8	
Internal power consumption (5 V DC)	mA	800	800	800	600	750	
Weight	kg	0.26	0.26	0.26	0.15	0.16	
Dimensions (WxHxD)	mm	27.4x98x115	27.4x98x115	27.4x98x115	27.4x98x90	27.4x98x90	
<b>Order information</b>	Art. no.	297645	297646	269032	248702	248703	248704

■ Interface modules

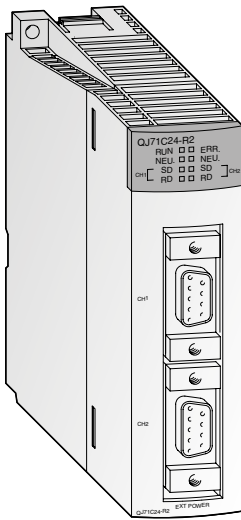

**Data exchange with peripheral devices**

This module enables communication with peripheral devices via a standard RS232 interface. The peripherals are connected point-to-point on a 1:1 basis.

**Special features:**

- The QJ71C24N provides one RS232 and one RS422/485 interface. The QJ71C24-R2 provides two RS232 interfaces and the QJ71C24N-R4 two RS422/485 interfaces.
- Enables PCs connected to the system to access the full data set of the MELSEC System Q CPU using graphic process supervision or monitoring software
- Integrated flash ROM memory for logging quality, productivity or alarm data that can be printed out when required
- Module and communications status shown by LEDs
- Communications test and monitor function are possible with the software GX-Configurator UT
- The QJ71MB71 and the QJ71MT91 support the master function of the MODBUS communication.

Specifications		QJ71C24N	QJ71C24N-R2	QJ71C24N-R4	QJ71MB91	QJ71MT91
Interface	channel 1	RS232 (9-pin Sub-D)	RS232 (9-pin Sub-D)	RS422/RS485 (screw terminals)	RS232 (9-pin Sub-D)	Ethernet (RJ45)
	channel 2	RS422/RS485 (screw terminals)	RS232 (9-pin Sub-D)	RS422/RS485 (screw terminals)	RS422/RS485 (screw terminals)	—
Communication mode		Full duplex/half duplex	Full duplex/half duplex	Full duplex/half duplex	Full duplex/half duplex	—
Synchronisation		Asynchronous communications	Asynchronous communications	Asynchronous communications	Master/Slave	Master/Slave
Data transfer	Rate	50–230400 (channel 1 only) 115200 (channel 1+2 simultaneously)	50–230400 (channel 1 only) 115200 (channel 1+2 simultaneously)	50–230400 (channel 1 only) 115200 (channel 1+2 simultaneously)	300–115200	10 Mbps/100 Mbps
	Distance RS232	m 15	15	—	15	200 m, max. segment length: 100 m
	Distance RS422/485	m 1200 (if both channels are used)	—	1200 (if both channels are used)	1200	—
Network configuration		RS232: 1:1 RS485: 1:1; 1:n;n: 1; m:m	1:1	RS232: 1:1 RS485: 1:1; 1:n;n: 1; m:m	Master (32 slaves) Slave (242)	Master (32 slaves) Slave (242)
Data format		1 start bit, 7 or 8 data bits, 1 or 0 parity bits, 1 or 2 stop bits	1 start bit, 7 or 8 data bits, 1 or 0 parity bits, 1 or 2 stop bits	1 start bit, 7 or 8 data bits, 1 or 0 parity bits, 1 or 2 stop bits	Modbus RTU	Modbus RTU
Error correction		Parity check, checksum	Parity check, checksum	Parity check, checksum	—	—
DTR/DSR control		YES/NO selectable	YES/NO selectable	—	—	—
X ON/X OFF (DC1/DC3)		YES/NO selectable	YES/NO selectable	YES/NO selectable	—	—
Occupied I/O points		32	32	32	32	32
Internal power consumption (5 V DC)		310 mA	260	390	310	520
Weight		kg 0.2	0.2	0.2	0.2	0.11
Dimensions (WxHxD)		mm 27.4x98x90	27.4x98x90	27.4x98x90	27.4x98x90	27.4x98x90
<b>Order information</b>		Art. no. 149500	149501	149502	167757	155603

## High-speed communication modules

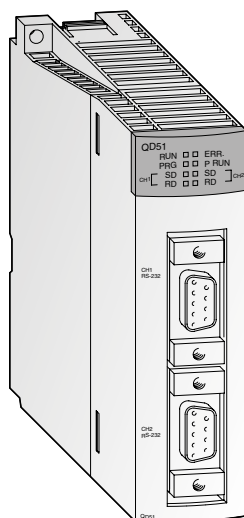

### Programmable interface module

This module works through its own program independently of the PLC CPU. Thus, peripherals can be operated or mathematical operations performed without imposing an additional load on the PLC CPU. Programming is in AD51H-BASIC.

#### Special features:

- Two RS232C interfaces and one RS422/485 interface
- Two BASIC programs can be operated in parallel (multitasking).
- The tasks can be stored in the module as interpreter programs or in compiled form.
- The integrated Flash ROM is used for storage.
- Online and offline program creation is possible.
- The module and communication status is indicated by means of LEDs.
- Support for plain ASCII data exchange with connected devices such as barcode readers, scales and identification systems

Specifications	QD51-R24	QD51
Interfaces	1 x RS422/485, 1 x RS232	2 x RS232
Microprocessor	V53A (20 MHz)	V53A (20 MHz)
Number of parallel tasks	Max. 2	Max. 2
Start conditions for tasks	Started by power on, started by the start command from another task, start by an interruption from the PC CPU.	
Data transfer	Rate	≤38400
	Distance	500 (RS422/485), 15 (RS232C)
Program language	AD51H-BASIC	AD51H-BASIC
Internal memory	Program memory	64 x 1 task or 32 x 2 tasks
	Common memory or tasks	8
	Data buffer to PLC	6
	Extension relays	1024
	Extension data registers	1024 (2 kbyte)
Memory backup capability	Provided for common memory, extension relay and extension register.	
Memory for programs	Flash memory: 64 kbyte	Flash memory: 64 kbyte
Occupied I/O points	32 (1 slot)	32 (1 slot)
Internal power consumption (5 V DC)	mA 310	260
Weight	kg 0.2	0.2
Dimensions (WxHxD)	mm 27.4x98x90	27.4x98x90
<b>Order information</b>	Art. no. 136385	136384
Accessories	For both modules: programming software for PC/AT (MS-DOS): SW1IX-AD51HPE, art. no.: 33102	

## Network modules

From simple stand alone systems and basic AS-Interface networks to Ethernet based networks and even Global networks based on Remote Telemetry Technology, Mitsubishi Electric provides a wide range of network solutions.

Below you can find an overview on the currently available network modules. For more detailed informations please contact your nearest Mitsubishi Electric distributor or the branch in your country.

### Ethernet modules

Module	Specifications	Art. no.
QJ71E71-100	10BASE-T/100BASE-TX	138327
QJ71E71-B2	10BASE2	129614
QJ71E71-B5	10BASE5	147287
QJ71MT91	Modbus®/TCP interface master/slave module	155603
NZ2EHG-T8	Compact-sized industrial switching HUB equipped with 8 ports capable of 1000BASE-T	259221
NZ2EHF-T8	Compact-sized industrial switching HUB equipped with 8 ports capable of 100BASE-T	259222

### MELSECNET/H modules

#### MASTER

Module	Specifications	Art. no.
QJ71LP21-25	Fiber optic cable, dual loop, 25 Mbps/10 Mbps	136391
QJ71LP21S-25	Fiber optic cable, dual loop, 25 Mbps/10 Mbps, With external power supply function	147632
QJ71LP21G	GI-50/125 fiber optic cable, dual loop, 10 Mbps	138958
QJ71LP21GE	GI-62.5/125 fiber optic cable, dual loop, 10 Mbps	138959
QJ71BR11	Coaxial cable, single bus, 10 Mbps	127592

#### REMOTE I/O

QJ72LP25-25	Fiber optic cable, dual loop, 25 Mbps/10 Mbps	136392
QJ72LP25G	GI-50/125 fiber optic cable, dual loop, 10 Mbps	138960
QJ72LP25GE	GI-62.5/125 fiber optic cable, dual loop, 10 Mbps	138961
QJ72BR15	Coaxial cable, single bus, 10 Mbps	136393

#### PC I/F BOARD (PCI BUS)

Q80BD-J71LP21-25	Fiber optic cable, dual loop, 25 Mbps/10 Mbps	136367
Q80BD-J71LP21G	GI-50/125 fiber optic cable, dual loop, 10 Mbps	138962
Q80BD-J71LP21GE	GI-62.5/125 fiber optic cable, dual loop, 10 Mbps	138963
Q80BD-J71BR11	Coaxial cable, single bus, 10 Mbps	136366

### CC-Link modules

#### MASTER/LOCAL

Module	Specifications	Art. no.
QJ61BT11N	CC-Link Ver. 2 compatible	154748
QJ61BT12	Master module for CC-Link Safety	203209

#### MASTER/LOCAL INTERFACE BOARD (PCI BUS)

Q80BD-J61BT11N	CC-Link Ver. 2 compatible	200758
----------------	---------------------------	--------

### CC-Link IE Control modules

Module	Specifications	Art. no.
QJ71GP21-SX	1 Gbps, master/slave module for FO GI	208815
QJ71GP21S-SX	1 Gbps, master/slave module for FO GI with external voltage supply	208816

#### MASTER/LOCAL INTERFACE BOARD (PCI BUS)

Q80BD-J71GP21-SX	1 Gbps, PCI PC card, master/slave for FO GI	208817
Q80BD-J71GP21S-SX	1 Gbps, PCI PC card, master/slave for FO GI with external voltage supply	208818

### CC-Link IE Field modules

Module	Specifications	Art. no.
QJ71GF11-T2	CC-Link IE Field master/local module	236484
QJ71GF11-T2	CC-Link IE Field master/local module	245177
NZ2GF-ETB	CC-Link IE Field network Ethernet adapter	253007

#### MASTER/LOCAL INTERFACE BOARD (PCI BUS)

Q81BD-J71GF11-T2	CC-Link IE Field PCI PC card, master/local module	253008
------------------	---	--------

### Profibus DP(V1) modules

Module	Specifications	Art. no.
QJ71PB92V	Interface master module (DP V1/V2)	165374
QJ71PB93D	Intelligent slave	143545

### Profinet module

Module	Specifications	Art. no.
ME1PN1FW-CCPU	Profinet master module	252935

### DeviceNet module

Module	Specifications	Art. no.
QJ71DN91	Interface master/slave module	136390

### AS-Interface module

Module	Specifications	Art. no.
QJ71AS92	AS-i Standard Version 2.11, dual network master	143531

### Modbus modules

Module	Specifications	Art. no.
QJ71MB91	Serial Modbus interface master/slave module	167757
QJ71MT91	Modbus/TCP interface master/slave module for Ethernet	155603

### Web server module

Module	Specifications	Art. no.
QJ71WS96	10BASE-T/100BASE-TX	147115

### SSCNETIII/H

Module	Specifications	Art. no.
Q172DSCPU	Motion controller, 16 axes	248700
Q173DSCPU	Motion controller, 32 axes	248701

### CANopen

Module	Specifications	Art. no.
ME3CAN1-Q	CANopen communication module	278799



## ■ Web server module

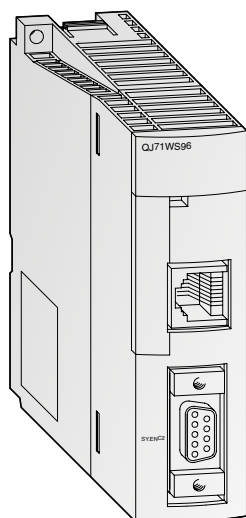

### Access to the MELEC System Q via the Internet

The web server module QJ71WS96 enables remote monitoring and maintenance of a MELSEC System Q PLC system via the Internet.

#### Special features:

- Very easy setting functions integrated
- User needs only a Web browser for setting and monitoring.
- RS232 interface for modem connection
- Various connections for data exchange are possible: ADSL, modem, LAN, etc.
- Sending and receiving data via mail or FTP
- Integration of a self-designed web site and Java applets is possible
- Standard connection via Ethernet to exchange data between other PLCs or PCs
- Events and CPU data protocol, storage functions

Specifications		QJ71WS96	
Module type		Web server, FTP server/client	
Transmission method		Ethernet: CSMA/CD	
Interface	type	10BASE-T/100BASE-TX (mode is recognized automatically)	
Communication speed	Mbps	10BASE-T: 10 Mbps/100BASE-TX: 100 Mbps	
Max. segment length	m	100 (between hub and node)	
RS232 communications data	Interface	RS232, 9-pin D-SUB	
	Transfer type	Duplex	
	Synchronisations method	Start/stop synchronisation	
	Transfer speed	Mbps	9.6/19.2/38.4/57.6/115.2
	Transmission distance	m	Max. 15
	Data format		1 start bit, 8 data bits, 1 stop bit
	Transfer control	Floating control is possible (RS/CS)	
Memory capacity	MB	5 (Standard-ROM); expandable with CompactFlash Card up to 512	
Occupied I/O points		32	
Internal power consumption (5 V DC)	mA	650	
Weight	kg	0.17	
Dimensions (WxHxD)	mm	27.5x98x90	
<b>Order information</b>	Art. no.	147115	

## ■ MES Interface module

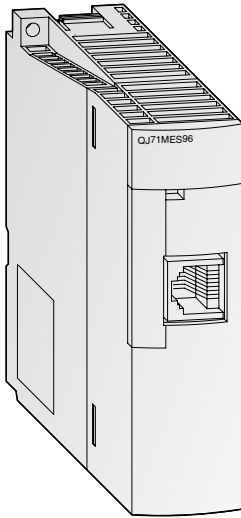

### Direct connection from the shop floor to the MES databases

The MELSEC Q series MES module allows users to interface their production control systems directly to an MES database. (MES: Manufacturing Execution System).

### Special features:

- It removes the need for an interfacing PC layer – reducing hardware costs and installation time.
- It removes the need for specialist interfacing software run on the PC layer; saving on expensive software and services while reducing installation costs.
- It simplifies the MES architecture reducing the total commissioning time.
- It can improve reliability and accessibility as the module is based on industrial PLC design standards.
- The simplified system provides greater direct data visibility increasing the opportunity to achieve higher productivity.

Specifications		QJ71MES96
Module type		MES Interface module
Transmission method		Ethernet
Interface type		10BASE-T/100BASE-TX
Data base interface function	Common	Interacts with databases via user-defined jobs
	Tag function	Collects device data of the PLC CPUs on the network in units of tags
	Trigger monitoring function	Monitors the status of conditions (time, tag, values etc.) that initiate jobs
	Trigger buffering function	The MES Interface module buffers the data and trigger time to internal memory
	SQL text transmission	Automatically generates the correct SQL message according to requirements of each supported database type.
	Arithmetic processing	Formulas can be applied to data before sending from the MES Interface module.
Program execution		Executes programs in the application server computer at the beginning and end of a job.
Software functions	No. of connected databases	32 items/project max.
	Supported databases	Oracle® 8i, Oracle® 9i, Oracle® 10g, Microsoft® SQL Server 2000, Microsoft® SQL Server 2000 Desktop Engine (MSDE2000), Microsoft® Access 2000, Microsoft® Access 2003
	No. of data settings	64 items/project max. (256 components/tag, 4096 components/project)
Memory capacity		1 CompactFlash card can be installed
Occupied I/O points		32
Internal power consumption (5 V DC)		mA 650
Weight		kg 0.16
Dimensions (WxHxD)		mm 27.5x98x90
<b>Order information</b>		Art. no. 200698

## ■ Q series C-Application server

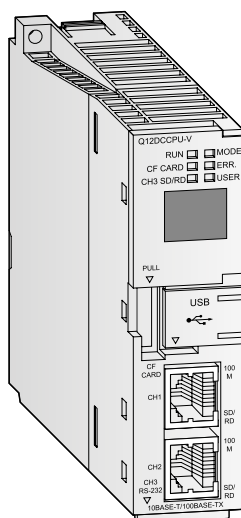

The C-Application server is based on the Q series C-Controller platform and with its robust OS has allowed Mitsubishi Electric to make a giant leap forward into the future of cloud connectivity. The C-Application server is based on modern web services and supports all kind of IoT requests. Its strength is to collect information in real time, provide analysis and forwards the results to a variety of cloud systems.

The C-Application server supports:

- Event handler – Asynchronous bi-direction HTTP(S) protocol
- LUA server pages, including LUA virtual machine
- SSL/TLS client/server including SSL certificate
- Raima database, SQLite, MySQL and Redis connectors
- Web services – JSON-RPC, XML-RPC and SOAP
- HTTP(S) client libraries
- Client and server (secure) TCP socket API
- Mail (SMTP) client

Specifications		C-Application server for Q12DCCPU-V
Transmission type		Ethernet, Serial
Interface		100BASE-TX, 10BASE-T, RS232
Database		SQLite3
Function		<ul style="list-style-type: none"> <li>● QBF and MD library function support</li> <li>● CAS specific functions</li> <li>● HTML5</li> <li>● Websocket</li> <li>● Lua API</li> <li>● Lua server pages</li> <li>● XML parser</li> <li>● Event handler</li> <li>● REST, AJAX, SOAP, JSON, XML-RPC Web-Services</li> <li>● WebDAV</li> <li>● SMTP</li> <li>● SSL, Shark SSL</li> <li>● PikeHTTP</li> </ul>
Weight	kg	0.24
Dimensions (WxHxD)	mm	27.4x98x115
Order information	Art. no.	289014

## High-speed data logger module

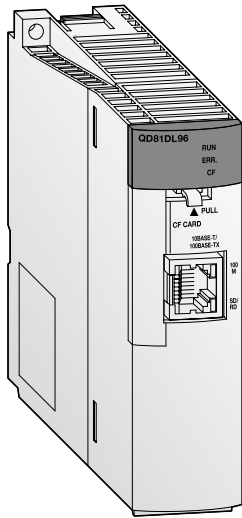

### Easy data logging

The high-speed data logger module can log programmable controller devices without using a personal computer.

By easily configuring the module, sampled data can be saved in the optimal file format to a CompactFlash card.

### Special features:

- Trigger logging function for accelerated problem analysis
- Data can be saved in list or report format to a CompactFlash Card
- Equipment error detection and failure prediction
- A single QD81DL96 module can access up to a maximum of 64 PLC CPUs

Specifications		QD81DL96
Ethernet	Interface <sup>①</sup>	10BASE-T/100BASE-TX
	Data transmission rate	10BASE-T: 10 Mbps/100BASE-TX: 100 Mbps
	Transmission method	Base band
	No. of cascaded stages	10BASE-T: max. 4/100BASE-TX: max. 2
	Max. segment length <sup>②</sup>	m 100
	Supported function	Auto-negotiation function supported (automatically distinguishes 10BASE-T/100BASE-TX)
CompactFlash card	Supply power voltage	3.3 V ±5 %
	Supply power capacity	mA Max. 150
	Card size	TYPE I card
	No. of installable cards	1
Occupied I/O points		32
Clock		Obtained from a programmable controller CPU (in multiple CPU system, CPU No. 1) or SNTP server Time accuracy after obtaining the time is a daily variation of ±9.504 seconds <sup>③</sup>
Internal power consumption (5 V DC)		A 0.46
Weight		kg 0.15
Dimensions (WxHxD)		mm 27.4x98x90
<b>Order information</b>		Art. no. 221934

<sup>①</sup> The high-speed data logger module distinguishes 10BASE-T from 100BASE-TX according to the external device. For connection to a hub without an auto-negotiation function, set the hub to half-duplex communications mode.

<sup>②</sup> Distance between a hub and node.

<sup>③</sup> For programmable controller CPU, everyday (once in 24 hours); for SNTP server, re-obtains the time at the user specified interval.

## Interrupt module and high-speed inputs

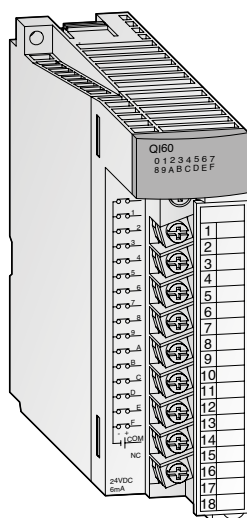

### Branching to subroutines

The interrupt module QI60 is suitable for applications demanding quick responses.

### Special features:

- Every input in this module is assigned to a pointer which serves as a branch mark for a subroutine.
- If an interrupt/alarm signal is applied at an input, the PLC program is interrupted after it has worked through the current statement and a subroutine assigned to the input is first processed.
- Galvanic isolation between process and controller by means of a photo-coupler is a standard feature
- Only one QI60 can be installed per PLC system

### High-speed input modules

- Fast response times, 5  $\mu$ s–1 ms adjustable
- Input voltage 24 V and 5 V
- Can be configured as interrupt or input modul

Specifications		QI60	QX40H	QX70H	QX80H	QX90H	
Input points		16	16	16	16	16	
Rated input voltage	V DC	24 (sink type)	24	5	24	5	
Operating voltage range	V DC	20.4–28.8	20.4–28.8	4.25–6	20.4–28.8	4.25–6	
Max. input points simultaneous ON		100 %	100 %*	100 %	100 %*	100 %	
Input	Resistance	k $\Omega$	Approx. 3.9	approx. 3.9	approx. 0.47	approx. 3.9	approx. 0.47
	Current	mA	Approx. DC 4/8	approx. DC 6	approx. DC 6	approx. DC 6	approx. DC 6
ON	Voltage	V	$\geq$ DC 19	$\geq$ DC 13	$\geq$ DC 3.5	$\geq$ DC 13	$\geq$ DC 3.5
	Current	mA	$\geq$ DC 4	$\geq$ DC 3	$\geq$ DC 3	$\geq$ DC 3	$\geq$ DC 3
OFF	Voltage	V	$\leq$ DC 11	$\leq$ DC 8	$\leq$ DC 1	$\leq$ DC 8	$\leq$ DC 1
	Current	mA	$\leq$ DC 1.7	$\leq$ DC 1.6	$\leq$ DC 1	$\leq$ DC 1.6	$\leq$ DC 1
Response time	OFF $\rightarrow$ ON	ms	$\leq$ 0.2	0.04–0.95 (adjustable)	0.04–0.95 (adjustable)	0.04–0.95 (adjustable)	0.04–0.95 (adjustable)
	ON $\rightarrow$ OFF	ms	$\leq$ 0.3	0.04–0.95 (adjustable)	0.04–0.95 (adjustable)	0.04–0.95 (adjustable)	0.04–0.95 (adjustable)
Status display of inputs		LED	LED	LED	LED	LED	
Insulation method		All modules are fitted with photocoupler isolation between input terminals and internal circuit.					
Occupied I/O points		16	16	16	16	16	
Connection terminal		The module is fitted with a terminal block with 18 screw terminals.					
Applicable wire size	mm <sup>2</sup>	0.3–0.75	0.3–0.75	0.3–0.75	0.3–0.75	0.3–0.75	
Internal power consumption (5 V DC)	mA	60 (all points ON)	80 (all points ON)	80 (all points ON)	80 (all points ON)	80 (all points ON)	
Weight	kg	0.20	0.16	0.16	0.16	0.16	
Dimensions (WxHxD)	mm	27.4x98x90	27.4x98x90	27.4x98x90	27.4x98x90	27.4x98x90	
Order information	Art. no.	136395	221844	221855	221856	221857	

Accessories for System Q from page 114 onward!

■ Base units

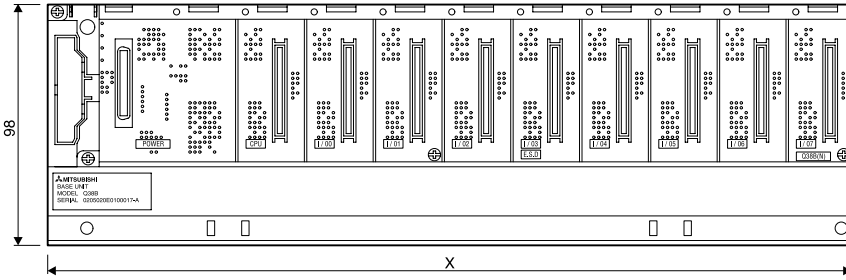

Type	X (in mm)
Q325B	114
Q33B	189
Q335B	142
Q35B/Q35DB	245
Q355B	197.5
Q38B/Q38DB	328
Q312B/Q312DB	439
Q52B	106
Q55B	189
Q63B	189
Q66B	245
Q68B	328
Q612B	439

■ Base units (with redundant power supply)

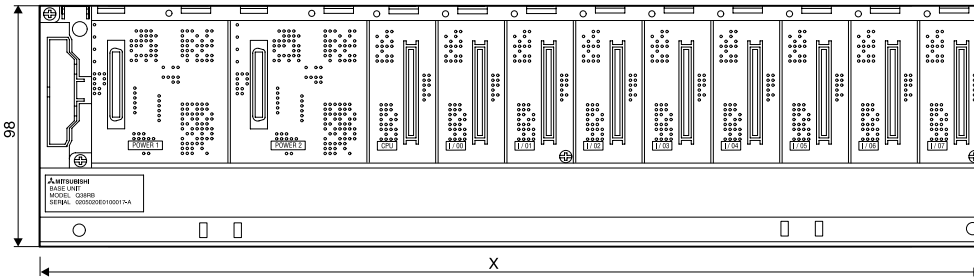

Type	X (in mm)
Q38RB	439
Q68RB	439
Q65WRB	439

■ CPUs and power supply modules

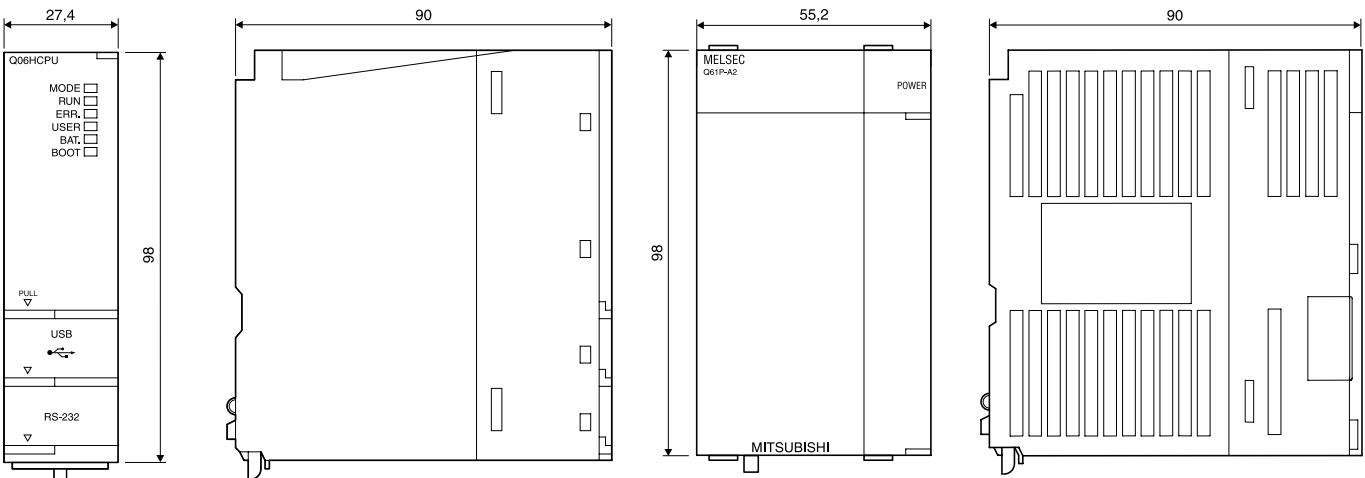

Unit: mm

### ■ Safety main base unit

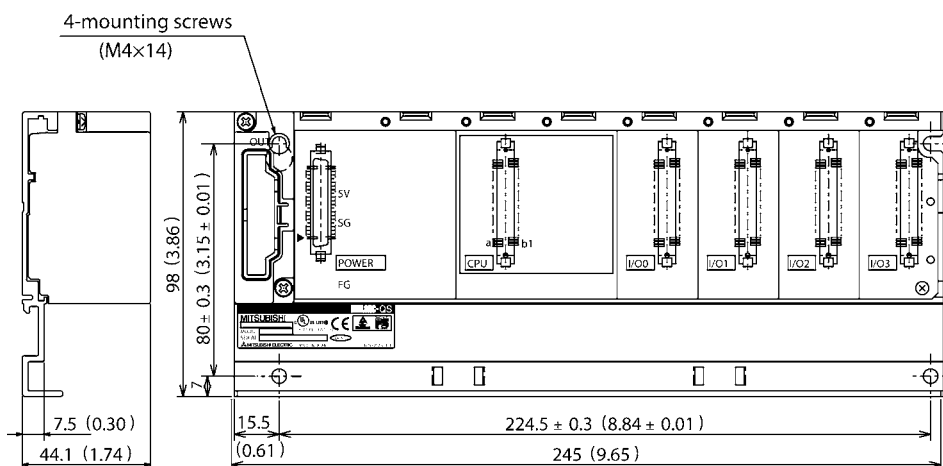

Type	X (in mm)
QS034B-E	245

Unit: mm

### ■ Safety CPU and power supply module

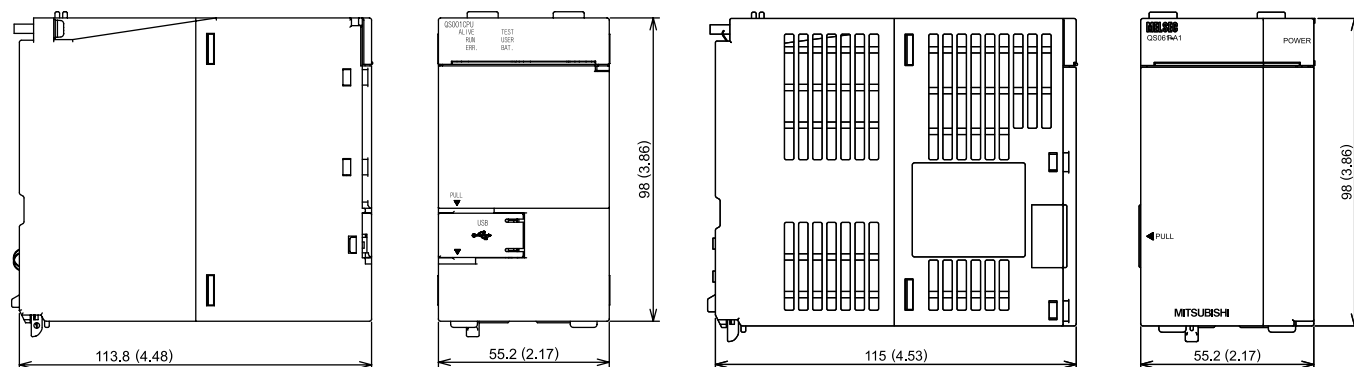

Unit: mm

■ CPUs and power supply modules (redundant)

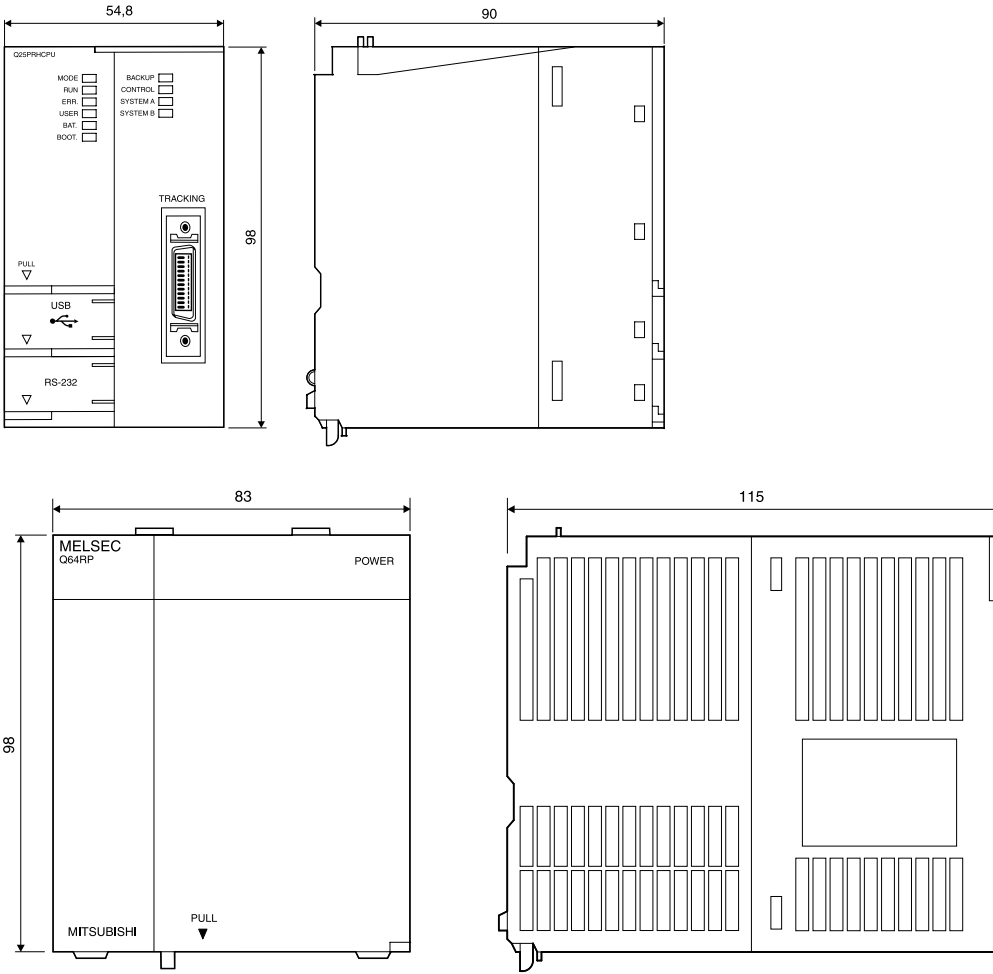

Unit: mm

■ I/O modules and special function modules

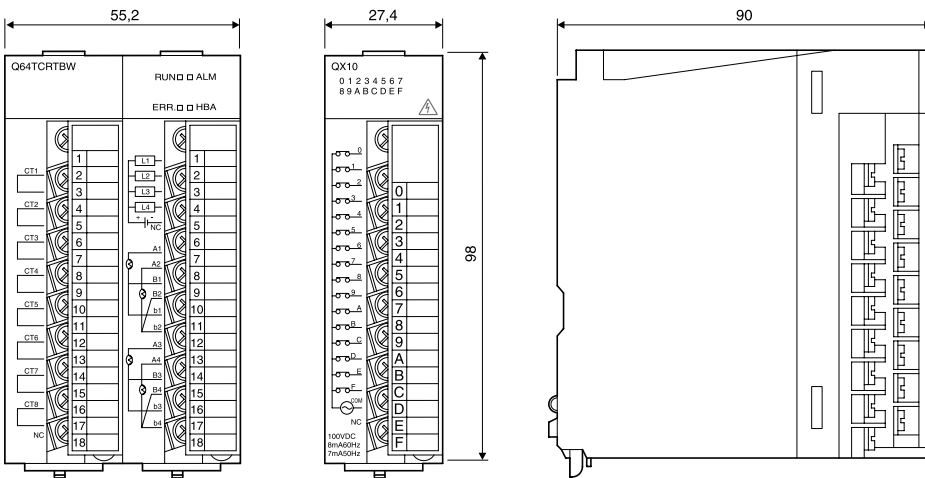

Unit: mm



### Terminal block adapters

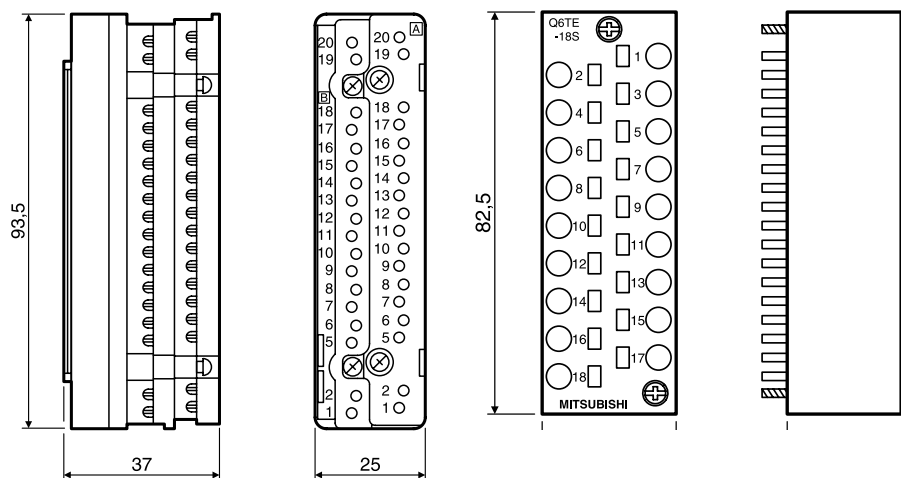

### Connectors

A6CON2

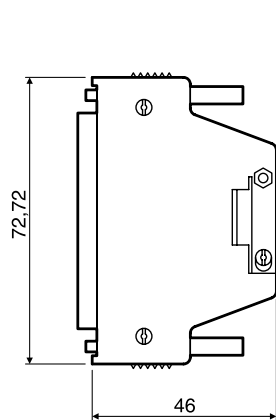

A6CON4

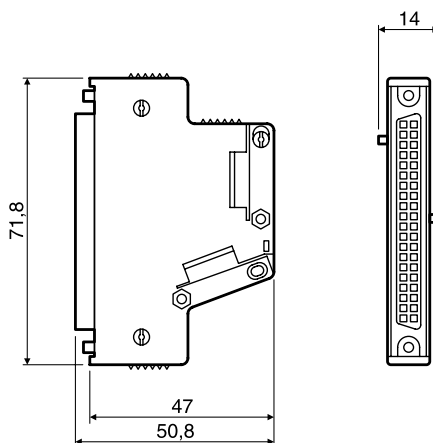

A6CON3

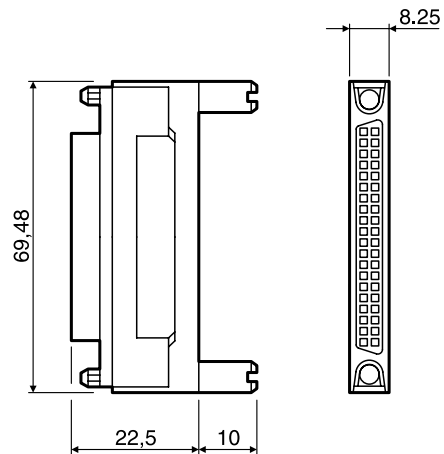

Unit: mm

## MELSEC L series

### Little on size, large on performance

The MELSEC L series is a powerful but compact modular controller with many features built-in to the CPU itself. The rack-free design promotes high system flexibility with minimum form factor. Built-in Mini-B USB and Ethernet allow for easy communication, along with a built-in SD/SDHC memory slot for data logging and memory storage, and built-in digital I/O for simple high-speed counting and positioning functions.

The high-performance version CPU also includes a built-in CC-Link interface for Master/Local Station networking. This highly flexible architecture makes the L Series ideal for both stand-alone and networked machines.

- Built-in I/O features
- Communication and networking capabilities
- High-end 4/16-axis motion expansion possible using SSCNETIII

- Rack-free design
- CPUs packed with comprehensive built-in features/functions
- Integrated data logging

4

MELSEC L series

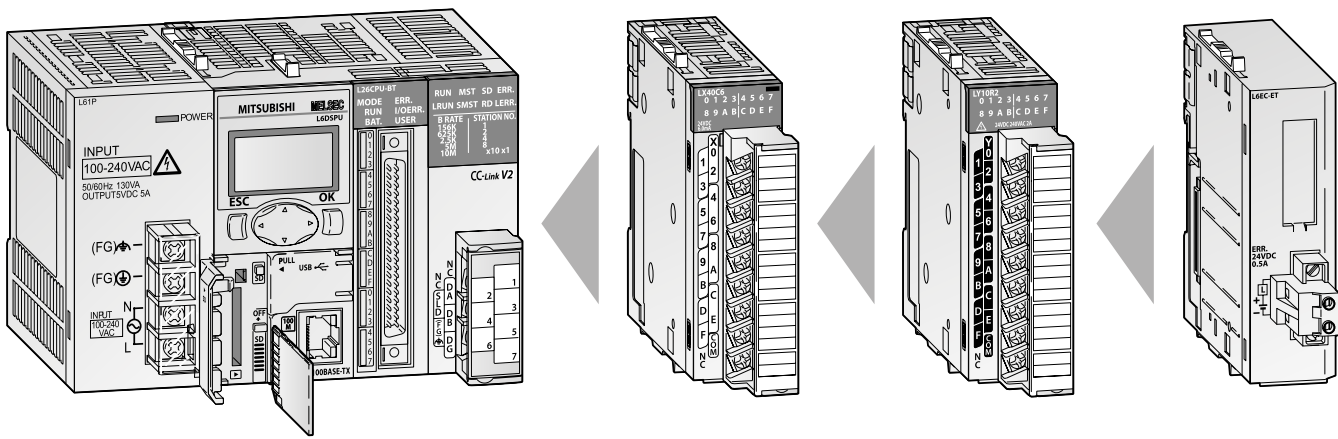

### Equipment features

The modular design of MELSEC L series allows flexible usage in a broad range of applications. The following modules are available for assembling and expanding the system:

#### Use of digital and special function modules

The use of digital and analog modules and most special function modules is dependent only on the maximum available number of addresses and thus on the CPU used in each case.

#### Communications modules

Modules with RS232/RS422/RS485 interface to connect devices for PLC-to-PLC communication. IO-Link module for the connection of intelligent sensors.

#### Network modules

For interfacing with CC-Link or CC-Link IE networks.

#### Positioning modules

High-speed counter modules with possibility for connection of incremental shaft encoder or multiaxial positioning modules for servo and step drives with up to 4 axes per module.

#### Digital input/output modules

For various signal levels with transistor, or relay switches.

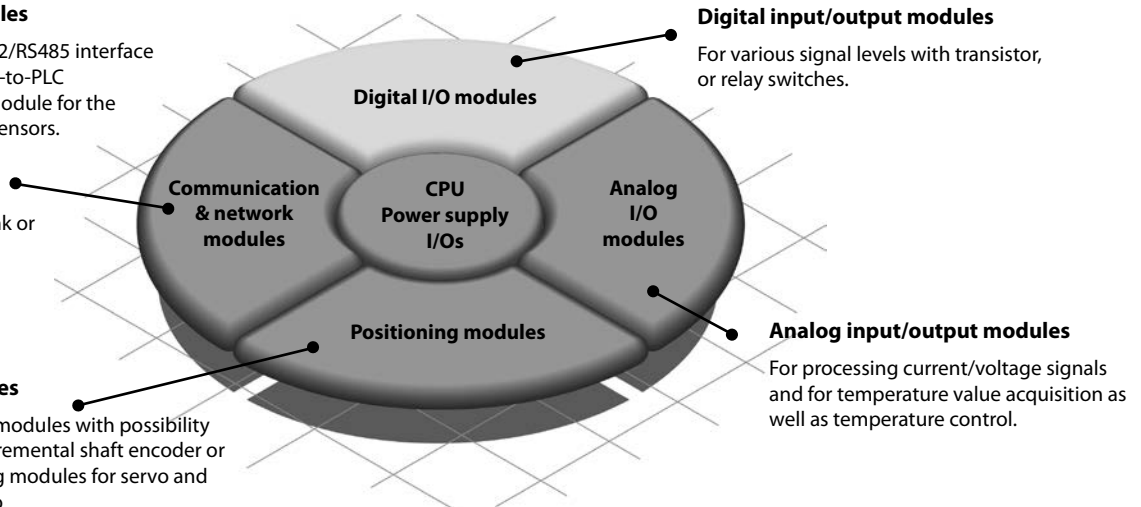

## What a system looks like

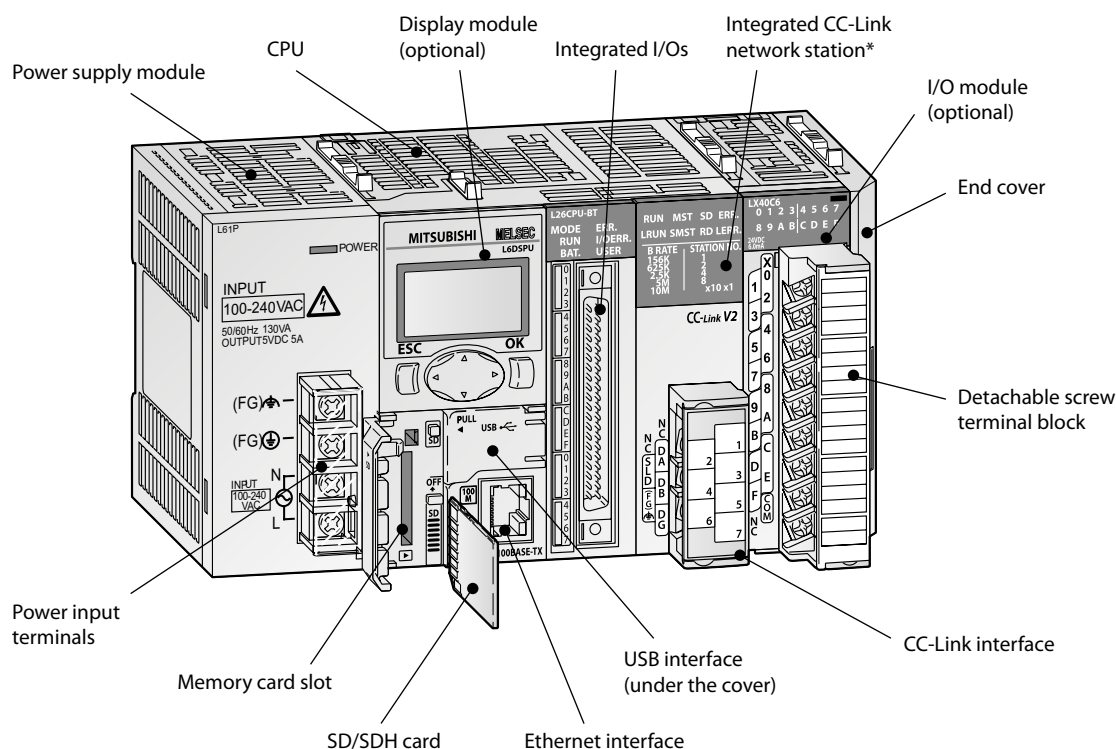

\* High-performance CPU only

### System structure

The L series is a powerful but compact modular controller with many features built-in to the CPU itself. The rack-free design promotes high system flexibility with minimum form factor. By connecting various types of modules, the system can be enhanced according to the application. Up to 40 expansion modules can be added per system configuration. As a baseless structure is employed, the space of the control panel can be used effectively without being limited by the size of the base.

MELSEC L series controllers are all-in-one programmable controllers that have the following functions built into the CPU module:

- 2 channels of high-speed counters up to 200 kHz
- Positioning possibilities for two axes, also up to 200 k pulses per second
- Built-in Ethernet communication
- Built-in I/Os which are available via a 40-pin high density connector supporting several I/O options
- High-speed data logging to the SD memory card
- CC-Link Ver. 2 Master/Slave interface (in the high-performance CPU)
- Full support in iQ Works and GX Works2

## What you need

### Power supply

This provides 5 V DC power for all modules on the back plane. There are two types of power supplies available, the selection is dependant on the available supply voltage.

### CPU

There are two CPU types available: standard and high-performance. Both CPUs come with built-in Mini-B USB and Ethernet for easy communication, along with a built-in SD/SDHC memory slot for data logging and memory storage, as well as built-in digital I/Os for simple high-speed counting and positioning functions.

The high-performance version CPU also includes a CC-Link interface for Master/Local station networking.

### I/Os

There is a wide selection of digital input and output modules depending on the signal level, sink or source designation and density of points required. Modules are available in 16 point input or output with screw terminals mounted on the module, higher densities of 32 and 64 point require a connector, cable and terminal block.

### Special function modules

For special applications analog I/O and intelligent modules for motion, positioning, high-speed counting, communication, and networking are available.

## Power supply

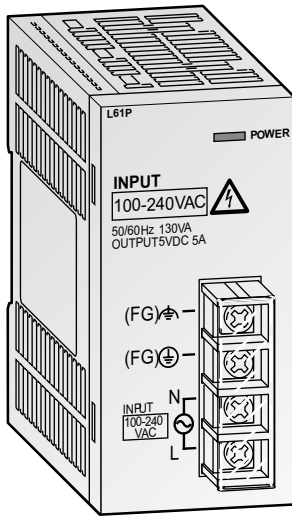

These units power the CPU and all connected modules. The choice is dependent on the input power that is available.

### Special features:

- The power supply L61P is operated with a voltage of 100 to 240 VA C at 50/60 Hz and can be used worldwide.
- The power supply L63P is connected to 24 V DC.
- The slim type L63SP with approx. two-thirds the size of a normal power supply is perfect for saving space with control panel.
- LED indicator for operating status
- Screw terminals for power input on the front side

4

MELSEC L series

Specifications		L61P	L63P	L63SP
Input voltage	(+10 %, -15 %) V AC	100–240	—	—
	(+30 %, -35 %) V DC	—	24	24
Input frequency	Hz	50/60 (±5 %)	—	—
Inrush current		20 A within 8 ms	100 A within 1 ms (24 V DC input)	100 A within 1 ms (24 V DC input)
Max. input apparent power		130 VA	—	—
Max. input power		—	45 W	45 W
Rated output current (5 V DC)	A	5	5	5
Overcurrent protection (5 V DC)	A	≥5.5	≥5.5	≥5.5
Overvoltage protection	V	5.5–6.5 V	5.5–6.5 V	5.5–6.5 V
Efficiency		≥70 %	≥70 %	≥70 %
Max. compensation time at power failure	ms	Within 10 ms	Within 10 ms (24 V DC input)	Within 10 ms (24 V DC input)
Fuse		Built-in (not replaceable by the user)	Built-in (not replaceable by the user)	Built-in (not replaceable by the user)
Weight	kg	0.32	0.29	0.19
Dimensions (WxHxD)	mm	45x90x109	45x90x109	29x90x109
<b>Order information</b>	Art. no.	238063	238064	279592

## CPU modules

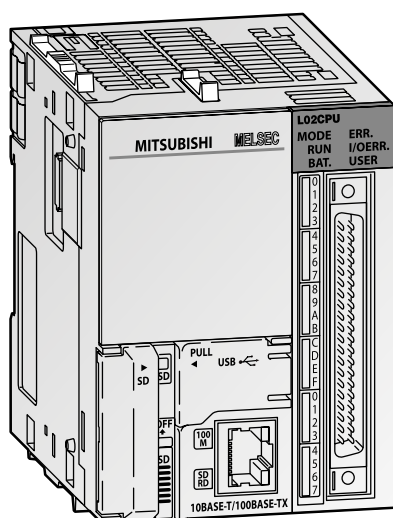

The CPU modules are the heart of a MELSEC L series system and contain a diverse range of control functions. Every CPU comes with 24 points of built-in I/Os.

For many standard applications the L02CPU(-P) or L02SCPU(-P) is appropriate. When higher operation processing speed is needed the L06CPU(-P) or L26CPU(-P)(BT) is the right choice. The L26CPU(-P)(BT) provides the highest program capacity. This CPU provides furthermore a built-in CC-Link connectivity.

### Special features:

- High-speed processing
- Large memory capacity
- Integrated Data logging
- Integrated USB port for programming
- Integrated Ethernet interface for efficient network or PC communication
- SD card memory slot for quick and easy back-up of programs and parameters

Specifications	L02SCPU/L02SCPU-P	L02CPU/L02CPU-P	L06CPU/L06CPU-P	L26CPU/L26CPU-P	L26CPU-BT/L26CPU-PBT
Control method	Stored program repeat operation				
I/O points	1024/8192*	1024/8192*	4096/8192*	4096/8192*	4096/8192*
Programming language	Function block, relay symbol language, MELSAP3 (SFC), MELSAP-L, structured text (ST), logic symbolic language				
Basic operation processing speed	60 ns	40 ns	9.5 ns	9.5 ns	9.5 ns
Program size (no. of steps)	20 k	20 k	60 k	260 k	260 k
Memory capacity	Program memory	80 k	80 k	240 k	1040 k
	Memory card	— Depends on the SD/SDHC memory card used			
	Standard RAM	128 k	128 k	768 k	768 k
	Standard ROM	512 k	512 k	2048 k	2048 k
Built-in functions	Integrated I/Os	16 inputs (24 V DC)/8 outputs (5–24 V DC, 0.1 A per channel) ①			
	Data logging	10 data logging settings (for each any of 32–4832 kB can be specified)			
	Communication	RS232	10 BASE-T/100 BASE-TX (10/100 Mbps)		
	CC-Link connectivity	—	—	—	—
Timer (T)	2048				
Counter (C)	1024*				
Relay (M)	8192*				
Latch relay (L)	8192*				
Edge relay (V)	2048*				
Special relay (SM)	2048				
Data register (D)	12288*				
Extended data register (D)	32768*		131072*		
Special register (SD)	2048				
File register (R)	32768 (max. 65536 points by switching blocks)		32768 (max. 393216 points by switching blocks)		
Interrupt pointer (I)	256				
Pointer (P)	4096				
Annunciator (F)	2048*				
Index register (Z)	10				
Link relay (B) / Link register (W)	8192*/8192*				
Function inputs (FX) / function outputs (FY)	16/16				
Function register (FD)	5				
Number of possible extensions	2		3		
Max. number of modules to be connected	Main block: 10 modules Extension block: 11 modules				
Internal power consumption (5 V DC)	A	0.75 (without display unit) 0 (with display unit)	0.94 (without display unit) 1.00 (with display unit)	1.00 (without display unit) 1.06 (with display unit)	1.00 (without display unit) 1.06 (with display unit)
Weight	kg	0.32	0.37	0.47	0.47
Dimensions (WxHxD)	mm	70x90x95	70x90x95	70x90x95	98.5x90x118
<b>Order information</b>	Art. no.	263070/269668	238057/244976	263068/**	263069/**
				263069/**	238056/244977

\* Number of points available on a program \*\* On request

① Model name with "P": source type digital output, model name without "P": sink type digital output.

## Digital input modules

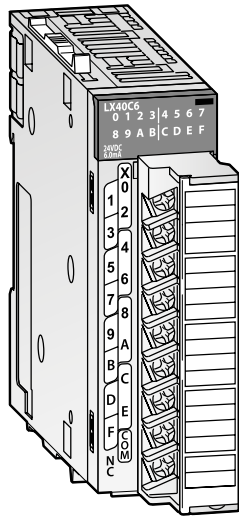

### Detection of digital input signals

Various input modules are available for converting digital process signals with different voltage levels into the levels required by the PLC.

All models are capable of using both positive or negative common connections, so that separate modules are not necessary.

### Special features:

- Indication of input status via LED
- Positive/negative common
- Response time 1 to 70 ms
- Modules with 16, 32 or 64 input points available

Specifications		LX40C6	LX10	LX41C4	LX28	LX42C4
Number of input points		16	16	32	8	64
Rated input voltage		V DC 20.4–28.8	100–120 V AC, 50/60 Hz	20.4–28.8	100–240 V AC, 50/60 Hz	20.4–28.8
Rated input current		mA 6.0	8.2 (100 V AC, 60 Hz) 6.8 (100 V AC, 50 Hz)	4.0	16.4 (200 V AC, 60 Hz) 13.7 (200 V AC, 50 Hz) 8.2 (100 V AC, 60 Hz) 6.8 (100 V AC, 50 Hz)	4.0
Input derating (for rated voltage)		100 %	100 % (at 50 °C)	100 %	100 % (at 50 °C)	100 % (at 35 °C)
ON	Voltage V	≥15	≥80	≥19	≥80	≥19
	Current mA	≥4	≥5	≥3	≥5	≥3
OFF	Voltage V	≤8	≤30	≤9	≤30	≤9
	Current mA	≤2	≤1.7	≤1.7	≤1.7	≤1.7
Response time		ms ≤1–70 ①	OFF → ON: ≤15 ON → OFF: ≤20	ms ≤1–70 ①	OFF → ON: ≤10 ON → OFF: ≤20	ms ≤1–70 ①
Inputs per group:		16	16	32	16	32
Occupied I/O points		16	16	32	16	64
Status display for the inputs		As operation indicator, all modules are equipped with a LED for each input.				
Connection terminal		18-point removable terminal block with screws	18-point removable terminal block with screws	40-pin connector	18-point removable terminal block with screws	40-pin connector x 2
Internal power consumption (5 V DC)		mA 90	90	100	80	120
Weight		kg 0.15	0.17	0.11	0.15	0.12
Dimensions (WxHxD)		mm 28.5x90x117	28.5x90x117	28.5x90x95	28.5x90x117	28.5x90x95
<b>Order information</b>		Art. no. 238085	255566	238086	255567	238087

① Can be changed in the PLC parameters (Default: 10 ms)

## ■ Digital output modules

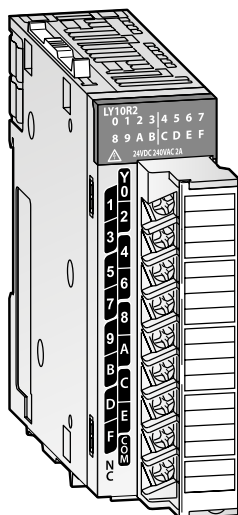

### Switching of external processes and devices

The MELSEC L series output modules have different number of outputs and different switching elements for adaptation to many control tasks.

Modules are built with countermeasures in case of external load short-circuits to protect against over-current and overheating.

### Special features:

- Indication of output status via LED
- Sink and source type modules available
- Response time less than 0.5 ms for transistor output modules
- Modules with 16, 32 or 64 output points available

Specifications	LY10R2	LY18R2A	LY28S1A	LY20S6	LY40NT5P	LY41NT1P	LY42NT1P	LY40PT5P	LY41PT1P	LY42PT1P	
Number of output points	16	8	8	16	16	32	64	16	32	64	
Output type	Relay	Isolated Relay	Isolated Triac	Triac	Transistor (sink type)	Transistor (sink type)	Transistor (sink type)	Transistor (source type)	Transistor (source type)	Transistor (source type)	
Outputs in groups of	16	8	8	16	16	32	32	16	32	32	
Rated load voltage	24 V DC/240 V AC	24 V DC/240 V AC	100–240 V AC, 50/60 Hz	100–240 V AC, 50/60 Hz	24 V DC	24 V DC	24 V DC	24 V DC	24 V DC	24 V DC	
Max. switching load	A	2 (8 common)	1 (8/module)	0.6 (4.8 common)	0.5 (5 common)	0.1 (2 common)	0.1 (2 common)	0.5 (5 common)	0.1 (2 common)	0.1 (2 common)	
Response time	OFF → ON	≤10	≤10	Total of 1 ms and 0.5 cycles or less	Total of 1 ms and 0.5 cycles or less	≤0.5	≤0.5	≤0.5	≤0.5	≤0.5	
	ON → OFF	≤12	≤12	Total of 1 ms and 0.5 cycles or less (resistive load)	Total of 1 ms and 0.5 cycles or less (resistive load)	≤1	≤1	≤1	≤1	≤1	
Load voltage range	<125 V DC/ <264 V AC	<125 V DC/ <264 V AC	<264 V AC	85–264 V AC	10.2–28.8 V DC	10.2–28.8 V DC	10.2–28.8 V DC	10.2–28.8 V DC	10.2–28.8 V DC	10.2–28.8 V DC	
Protective functions	—	—	—	—	Overload protection function, overheat protection function						
Occupied I/O points	16	16	16	16	16	32	64	16	32	64	
Status display for the outputs	As operation indicator, modules with 16 or 32 outputs are equipped with a LED for each output. Modules with 64 outputs have a switchable display with 32 LEDs.										
Connection terminal	18-point removable terminal block with screws	18-point removable terminal block with screws	18-point removable terminal block with screws	18-point removable terminal block with screws	18-point removable terminal block with screws	40-pin connector	40-pin connector x 2	18-point removable terminal block with screws	40-pin connector	40-pin connector x 2	
External power supply of the module	—	—	—	—	10.2–28.8 V DC, 9 mA	10.2–28.8 V DC, 13 mA	10.2–28.8 V DC, 9 mA	10.2–28.8 V DC, 17 mA	10.2–28.8 V DC, 20 mA	10.2–28.8 V DC, 20 mA	
Internal power consumption 5 V DC	mA	460	260	200	300	100	140	190	100	140	
Weight	kg	0.21	0.18	0.19	0.22	0.15	0.11	0.12	0.15	0.11	
Dimensions (WxHxD)	mm	28.5x90x117	28.5x90x117	28.5x90x117	28.5x90x117	28.5x90x95	28.5x90x95	28.5x90x95	28.5x90x95	28.5x90x95	
Order information	Art. no.	238088	279074	279075	255568	242167	238089	238090	242168	242169	242170

## IO-Link module

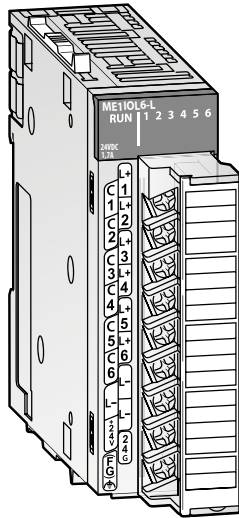

### Master module for IO-Link

IO-Link is an extension of conventional digital inputs and outputs and allows the connection of intelligent sensors and actuators to a PLC. The 32-byte input and output data for each device are transmitted over standard cables, special bus cables or communication settings are not necessary.

### Special features:

- Master module for up to six IO-Link devices
- Each channel of the ME1IOL6-L can also be configured as a normal digital input or output.
- Masking of input data simplifies the data processing by the PLC CPU
- At a stop of the PLC CPU, the output states can either be deleted or retained.
- The parameterized device configuration is checked at the beginning of the IO-Link communication and deviations are detected.
- Storage of the parameters of the IO-Link devices allows the rapid exchange of the device

Specifications		ME1IOL6-L
Nbr. of channels		6
Channel configuration		IO-Link, digital output, digital input, disabled
IO-Link	Rated load voltage	24 V DC
	Rated output current	15 mA
	Sensor/actuator power supply	200 mA
	Common point	Positive
Digital input	Rated load voltage	24 V DC
	Rated input current	5 mA
	Input filter	200 μs
	Rated load voltage	24 V DC
Digital output	Output type	Source
	Rated output current	In total max. 215 mA
Actuator supply		In total max. 215 mA
Protective functions		Overcurrent, overload, short circuit
Occupied I/O points		32
Connection terminal		18-point removable terminal block with screws
Applicable cables	Cable type	Unshielded cable
	Max. length	20 m
	Cross-section	0.3–0.75 mm <sup>2</sup>
External power consumption	Voltage	24 V DC (+20 %, -15 %)
	Current	Max. 1.7 A
Weight	kg	0.18
Dimensions (WxHxD)	mm	28.5x90x117
<b>Order information</b>	Art. no.	245825



## ■ Analog input modules

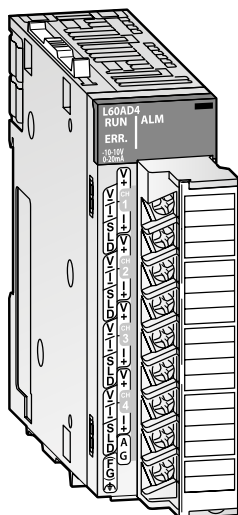

### Analog to digital conversion

The analog input module converts analog process signals, for example pressure, flow or fill level, linearly into digital values, which are further processed by the L series CPU.

The analog input module L60AD4-2GH converts analog process signals into digital values with high accuracy. The channels are isolated between each other and against the external power supply with high dielectric withstand voltage for both. This eliminates the need for external isolation amplifiers.

### Special features:

- Channel isolated and high resolution (L60AD4-2GH)
- High-speed conversion of 20  $\mu$ s/channel
- High conversion accuracy of  $\pm 0.05$  %
- High resolution of 1/20000
- Ensured stability with variable conversion speed
- Easy parameter setting

Specifications	L60AD4	L60AD4-2GH	L60ADVL8	L60ADIL8
Input points	4	4	8	8
Analog input	Voltage	V DC -10–10	-10–10	—
	Current	mA DC 0–20	0–20	0–20
Digital output	-20480–20479 (-32768–32767)*	-32000–32000 (-32768–32767)*	-16384–16383 (-32768–32767)*	-8192–8191 (-32768–32767)*
Input resistance	Voltage	M $\Omega$ 1	1	1.8
	Current	$\Omega$ 250	250	—
Max. input	Voltage	V $\pm 15$	$\pm 15$	—
	Current	mA 30	30	—
I/O characteristics (Digital value)	Voltage	-20000–20000	-32000–32000	-16000–16000
	Current	0–20000	0–32000	—
Max. resolution	Voltage input	$\mu$ V 200	125	500
	Current input	nA 800	500	—
Overall accuracy	$\pm 0.2$ % (0–55 °C), $\pm 0.1$ % (20–30 °C)		$\pm 0.2$ % (20–30 °C), $\pm 1$ % (0–55 °C)	$\pm 0.2$ % (20–30 °C), $\pm 1$ % (0–55 °C)
Conversion speed	Depending on the function used: 1 ms/channel, 80 $\mu$ s/channel (default), 20 $\mu$ s/channel		40 $\mu$ s/2 channels	1 ms/channel
Insulation method	Photocoupler isolation between input terminals and power supply. No isolation between the channels.	Photocoupler isolation between input terminals and power supply. Transformer isolation between the channels.	Photocoupler isolation between input terminals and power supply. No isolation between the channels.	Photocoupler isolation between input terminals and power supply. No isolation between the channels.
Occupied I/O points	16	16	16	16
Connection terminal	18-point removable terminal block with screws	18-point removable terminal block with screws	18-point removable terminal block with screws	18-point removable terminal block with screws
Applicable wire size	mm <sup>2</sup> 0.3–0.75	0.3–0.75	0.3–0.75	0.3–0.75
Internal power consumption 5 V DC	mA 520	760	200	210
Weight	kg 0.19	0.20	0.20	0.19
Dimensions (WxHxD)	mm 28.5x90x117	28.5x90x117	28.5x90x117	28.5x90x117
<b>Order information</b>	Art. no. 238091	263071	279071	279065

\* Value in brackets when using the scaling function

## ■ Analog output modules

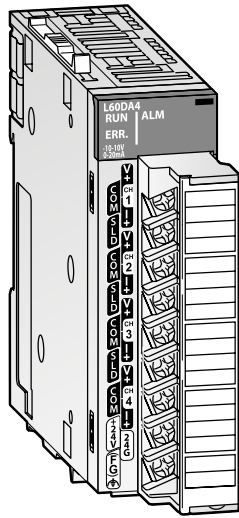

### Digital to analog conversion

The analog output module converts digital values predetermined by the CPU into analog current or voltage signal.

The L60DA4 can also output wave-shaped analog signals at its outputs. Any signal form can be easily defined using GX Works 2. This is then stored as digital values in the L60DA4. The signals, which are now independent of the PLC program, are particularly suitable for fast and accurate control of presses and injection moulding machines. In combination with a servo amplifier, this function is ideal for implementing profile torque regulation.

With the same basic functions of the L60DA4, the L60DAVL8 and L60DAIL8 can perform analog output (8 channels), which is two times as much as the L60DA4 per module.

### Special features:

- High-speed conversion of 200 µs/channel
- High conversion accuracy of ±0.1 %
- High resolution of 1/20000
- Easy parameter setting
- Integrated scaling function

Specifications		L60DA4	L60DAVL8	L60DAIL8
Output points		4	8	8
Digital input		-20480–20479 (-32768–32767)*	-16384–16383 (-32768–32767)*	-8192–8191 (-32768–32767)*
Analog output	Voltage	V DC -10–10	-10–10	—
	Current	mA DC 0–20	—	0–20
Load resistance	Voltage	MΩ 0.001–1	0.001–1	—
	Current	Ω 0–600	—	0–600
I/O characteristics		Digital value -20000–20000	-16000–16000	-8000–8000
Max. resolution	Voltage input	µV 200	320	—
	Current input	nA 700	—	707
Overall accuracy		±0.3 % (0–55 °C), ±0.1 % (20–30 °C)	±0.5 % (0–55 °C), ±0.3 % (20–30 °C)	±1.0 % (0–55 °C), ±0.3 % (20–30 °C)
Conversion speed		20 µs/channel	200 µs/channel	200 µs/channel
Insulation method		Photocoupler isolation between output terminals and power supply. No isolation between the channels. Transformer between external power supply and the outputs.		
Occupied I/O points		16	16	16
Connection terminal		18-point removable terminal block with screws	18-point removable terminal block with screws	18-point removable terminal block with screws
Applicable wire size		mm <sup>2</sup> 0.3–0.75	0.3–0.75	0.3–0.75
External power consumption		24 V DC, +20 %, -15 %, 0.18 A	24 V DC, +20 %, -15 %, 0.13 A	24 V DC, +20 %, -15 %, 0.25 A
Internal power consumption 5 V DC		mA 160	150	150
Weight		kg 0.20	0.22	0.22
Dimensions (WxHxD)		mm 28.5x90x117	45x90x117	45x90x117
Order information		Art. no. 238092	304494	304545

\* Value in brackets when using the scaling function

## Combined analog input/output module

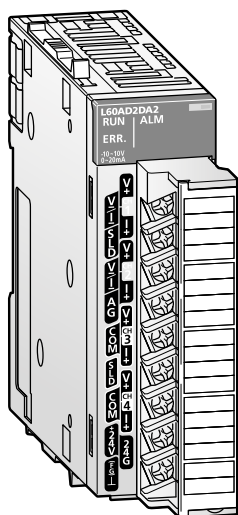

### L60AD2DA2

An analog I/O module has two sets of A/D conversion channels and D/A conversion channels.

#### Special features

- Scaling function
- Input signal error detection
- Logging function
- Wave output function
- Variable conversion characteristics function + variable arithmetic function
- PID control function
- Easy setting with GX Works3

Specifications		L60AD2DA2	
Input channels			2
Analog input	Voltage	V	-10–10
	Current	mA	0–20
Input resistance	Voltage	MΩ	1
	Current	Ω	250
Max. input	Voltage	V	±15
	Current	mA	30
I/O characteristics	Voltage input		-16000–16000
	Current input		12000–12000
Max. resolution	Voltage input	μV	333
	Current input	nA	1287
Accuracy			±0.3 % (0–55 °C), ±0.2 % (20–30 °C)
Conversion time			80 μs/channel (logging function/wave output function) 100 μs/channel (variable conversion characteristics function) 160 μs/channel (variable arithmetic function) 200 μs/channel (PID control function)
Output channels			2
Digital input			-16384–16383
Analog output	Voltage	V	-10–10
	Current	mA DC	0–20
Load resistance	Voltage output		1 kΩ–1 MΩ
	Current output	Ω	0–600
I/O characteristics	Voltage output		-16000–16000
	Current output		-12000–12000
Max. resolution	Voltage output	μV	319
	Current output	nA	696
Accuracy			±0.4 % (0–55 °C), ±0.2 % (20–30 °C)
Max. conversion time			80 μs/channel (logging function/wave output function) 100 μs/channel (variable conversion characteristics function) 320 μs/2 channels (variable arithmetic function) 200 μs/channel (PID control function)
Connection terminal			18-point removable terminal block with screws
Occupied I/O points			16
Internal power consumption 5 V DC	mA		170
Weight	kg		0.22
Dimensions (WxHxD)	mm		28.5x90x117
<b>Order information</b>	Art. no.		269673

## Multiple input module

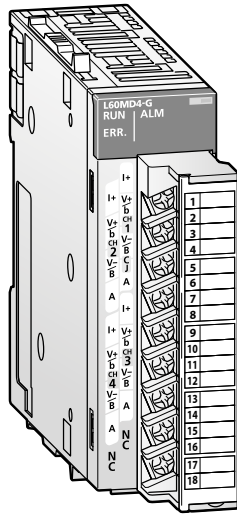

### One module covering voltage, current, micro-voltage, thermocouples and RTD

For each channel, it is possible to select from voltage, current, micro-voltage, thermocouples or RTD. As a result, dedicated modules required for each type of sensor can now be integrated into a single module.

The multiple input module also supports the Pt50 and JPt100 sensors, which are compatible with the former JIS standards. Modules can be replaced without altering the already existing sensor equipment.

### Special features:

- System with up to four channels (including analog and temperature input channels)
- Storing of maximum and minimum values.
- Scale conversion
- Comparing and monitoring an object
- Switching the Celsius/Fahrenheit display
- Stable measurement due to the isolation between channels
- Easy setting with GX Works3

Specifications		L60MD4-G	
Input points			4
Analog input	Voltage	V DC	-10–10
	Current	mA DC	0–20
	Thermocouple		K, J, T, E, N, R, S, B, U, L, PL II, W5Re/W26Re
	Micro voltage		-100–100 mV DC
Resistance temperature detector			Pt1000, Pt100, JPt100, Pt50
			-20480–20479 (-32768–32767)*
Digital output			
Input resistance	Voltage	MΩ	1
	Current	Ω	250
Max. input	Voltage	V	±15
	Current	mA	30
	Micro voltage		-20000–20000
	Temperature		RTD (Pt100, JPt100): Unit "Celsius": -2000–12000, Unit "Fahrenheit": 0–20000
Thermocouple and other RTD than Pt100 and JPt100			Unit "Celsius": -2700–23000, Unit "Fahrenheit": -4000–32000
I/O characteristics (Digital value)	Voltage		-20000–20000
	Current		0–20000
Max. resolution	Voltage input	μV	200
	Current input	nA	800
	Microvoltage	μV	5
	Temperature	°C	Thermocouple: 0.1 Resistance temperature detector: 0.03
Overall accuracy	Voltage/ current/ microvoltage	Ambient temperature 25 ±5 °C	Maximum value of the measurement range x (±0.3 %) (±60 digits)
		Ambient temperature 0–55 °C	Maximum value of the measurement range x (±0.9 %) (±180 digits)
	Temperature	Ambient temperature 25 ±5 °C	Thermocouple: Full scale x (±0.15 %)
		Ambient temperature 0–55 °C	Resistance temperature detector
Conversion speed			50 ms/channel
Insulation method			Photocoupler isolation between I/O terminals and power supply. Transformer isolation between the channels.
Occupied I/O points			16
Connection terminal			18-point removable terminal block with screws
Applicable wire size	mm <sup>2</sup>		0.3–0.75
Internal power consumption 5 V DC	mA		490
Weight	kg		0.19
Dimensions (WxHxD)	mm		28.5x90x117
<b>Order information</b>	Art. no.		279072

\* Value in brackets when using the scaling function

## Temperature input module

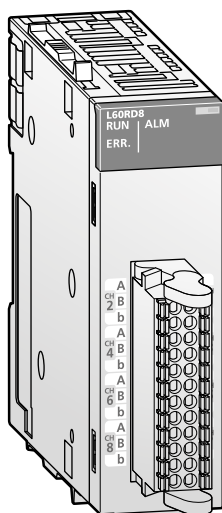

### 8-channel RTD input module with wide input ranges

The RTD input module converts temperature data input by a corresponding RTD (nine types: Pt100, JPt100, Pt1000, Pt50, Ni100, Ni120, Ni500, Cu100, or Cu50) to a temperature measured value and digital operation value.

#### Special features:

- 8 input channels with wider input ranges
- Reduced wiring time with no screw tightening
- Easier calibration
- Storing of maximum and minimum values
- Warning output function
- Scaling function
- Averaging processing
- Disconnection detection function

Specifications		L60RD8
Input channels		8
Output	Temperature measured value	-3280–15620
	Digital operation value	-32768–32767
Applicable RTD		Pt100, JPt100, Pt1000, Pt50, Ni100, Ni120, Ni500, Cu100 or Cu50
Measured temperature range	°C	Pt100: -20–120, -200–850; JPt100: -20–120, -200–600; Pt1000: -200–850; Pt50: -200–650; Ni100: -60–250; Ni120: -60–250; Ni500: -60–250; Cu100: -180–200; Cu50: -180–200
Conversion accuracy	Ambient temperature 25 ±5 °C	Measured temperature range accuracy at RTD input
	Ambient temperature 0–55 °C	
Resolution	°C	0.1
Conversion speed		40 ms/channel
Insulation method		Photocoupler isolation between input terminals and power supply. No isolation between the channels.
Occupied I/O points		16
Connection terminal		24-point spring clamp terminal block
Applicable wire size	mm <sup>2</sup>	0.5–1.5
Internal power consumption 5 V DC	mA	220
Weight	kg	0.15
Dimensions (WxHxD)	mm	28.5x90x116.5
Order information	Art. no.	289962

## Temperature control modules

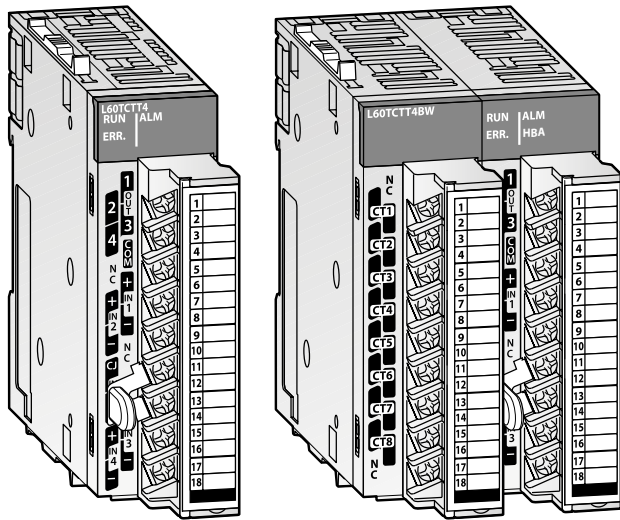

### Temperature control modules with PID algorithm

These modules apply the independent control of temperatures. This relieves the CPU of the PLC.

#### Special features:

- 4 channels for temperature detection and 4 separate loops of temperature adjustment per module
- Modules for thermocouples and for Pt100 resistance thermometers are available
- Auto tuning function for optimum temperature adjustment control (PID control)
- The modules or single channels of a module can also be used for temperature detection.
- Temperature control can continue even when the PLC program is stopped
- Heating current monitoring at modules L60TCTT4BW and L60TCRT4BW to detect a defective or disconnected heater.

Specifications	L60TCTT4	L60TCRT4	L60TCTT4BW	L60TCRT4BW	
Control output type	Transistor	Transistor	Transistor	Transistor	
Inputs	4 channels per module	4 channels per module	4 channels per module	4 channels per module	
Supported temperature sensors	Thermocouple	Pt100 resistance thermometer	Thermocouple	Pt100 resistance thermometer	
Sampling cycle	250 ms/4 channels	250 ms/4 channels	250 ms/4 channels	250 ms/4 channels	
Control output cycle	0.5–100 s	0.5–100	0.5–100	0.5–100	
Input filter	1–100 s (0 s: input filter OFF)				
Temperature control method	PID ON/OFF impulse or 2-position control				
PID constant range	Setting with automatic tuning possible				
	Proportional band P (0.0–1000 % (0 %: 2-position control))				
	Integral time I (1–3600 s (set 0 for P control and PD control))				
	Differential time D (1–3600 s (set 0 for P control and PI control))				
Target value setting range	Within the temperature range set in the thermocouples/resistance thermometers used				
Dead band setting range	0.1–10.0 %	0.1–10.0 %	0.1–10.0 %	0.1–10.0 %	
Transistor output	Output signal (sink)	ON/OFF pulse	ON/OFF pulse	ON/OFF pulse	
	Rated load voltage	10–30 V DC	10–30 V DC	10–30 V DC	
	Max. load current	0.1 A/1 point, 0.4 A/common	0.1 A/1 point, 0.4 A/common	0.1 A/1 point, 0.4 A/common	0.1 A/1 point, 0.4 A/common
	Max. rush current	400 mA for 10 ms	400 mA for 10 ms	400 mA for 10 ms	400 mA for 10 ms
	Max. voltage drop when ON	0.1 V DC (TYP) 0.1 A 2.5 V DC (MAX) 0.1 A	0.1 V DC (TYP) 0.1 A 2.5 V DC (MAX) 0.1 A	0.1 V DC (TYP) 0.1 A 2.5 V DC (MAX) 0.1 A	0.1 V DC (TYP) 0.1 A 2.5 V DC (MAX) 0.1 A
	Response time	OFF → ON: <2 ms ON → OFF: <2 ms	OFF → ON: <2 ms ON → OFF: <2 ms	OFF → ON: <2 ms ON → OFF: <2 ms	OFF → ON: <2 ms ON → OFF: <2 ms
Insulation method	Transformer between input channels and the power supply and between the inputs				
Occupied I/O points	16	16	16	16	
Connection terminals	All modules are fitted with a terminal block with 18 screw terminals.				
Applicable wire size	0.3–0.75 mm <sup>2</sup>	0.3–0.75	0.3–0.75	0.3–0.75	
Internal power consumption (5 V DC)	300 mA	310	330	350	
Weight	0.18 kg	0.18	0.33	0.33	
Dimensions (WxHxD)	28.5x90x117 mm	28.5x90x117	57x90x117	57x90x117	
Order information	Art. no. 246347	246348	246349	246350	

4 MELSEC L series

## Flexible high-speed I/O control module

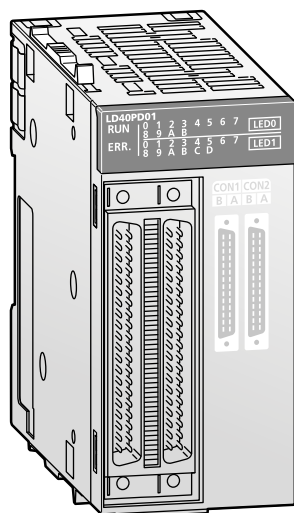

### Equipped with FPGA for high-speed I/O control

For the flexible high-speed I/O control module, users can easily create a high-speed, complicated hardware logic independent from the CPU module by graphically combining input/outputs, logical operation circuits, and counters with the configuration tool.

#### Special features:

- High-speed, high-response control with  $\mu$ s orders
- Controls with stable response time
- Logic controls that requires rapidity
- Measurement control with sensor inputs
- Controls triggered by external inputs

Specifications		LD40PD01			
		DC	Differential		
Number of input points		12 points (5/24 V DC/differential)			
Number of output points		8 points (5–24 V DC, 0.1 A/point)	6 points		
Number of interrupts		8 interrupts			
Input response time		$\leq 1 \mu$ s (pulse input speed: max. 200 kpulse/s)	$\leq 1 \mu$ s (pulse input speed: max. 8 Mpulse/s)		
Output response time		$\leq 1 \mu$ s (pulse input speed: max. 200 kpulse/s)	$\leq 1 \mu$ s (pulse input speed: max. 8 Mpulse/s)		
Main blocks (included in the configuration tool)	External input block	Logic select	Inverted, not inverted		
		Filter time	General input: 0 $\mu$ s, 10 $\mu$ s, 50 $\mu$ s, 0.1 ms, 0.2 ms, 0.4 ms, 0.6 ms, 1 ms, 5 ms Pulse input: 10 kpulse/s, 100 kpulse/s, 200 kpulse/s, 500 kpulse/s, 1 Mpulse/s, 2 Mpulse/s, 4 Mpulse/s, 8 Mpulse/s		
	Parallel encoder block	Input data type	Pure binary, gray code, BCD		
		Data length	1 bit–12 bits		
	SSI encoder block	Input data type	Pure binary, gray code		
		Data length	1 bit–32 bits (Data length for single turn, multi-turn, and status can be set.)		
	Counter timer block	Transmission speed	100 kHz, 200 kHz, 300 kHz, 400 kHz, 500 kHz, 1.0 MHz, 1.5 MHz, 2.0 MHz		
			Type	Addition, subtraction, linear counter mode, ring counter mode, addition mode, preset counter function, latch counter function, internal clock function	
		Internal clock	25 ns, 50 ns, 0.1 $\mu$ s, 1 $\mu$ s, 10 $\mu$ s, 100 $\mu$ s, 1 ms		
			Counting range	32-bit signed binary (-2147483648–2147483647), 32-bit unsigned binary (0–4294967295) 16-bit signed binary (-32768–32767), 16-bit unsigned binary (0–65535)	
		Compare block	Compare value	Same as the counting range	
			Compare mode	=, >, <, $\geq$ , $\leq$ , <>, within the range, outside the range	
		Cam switch block number of steps	Up to 16 steps		
		Set/reset block	Uses the signal input to the Set terminal as a trigger to output the High fixed signal. Uses the signal input to the Reset terminal as a trigger to output the Low fixed signal.		
		Logical operation block	Logical operation type	AND, OR, XOR	
		External output block	Logic select	Inverted, not inverted	
	Delay time		None, 12.5 ns, 25 ns, 50 ns, 0.1 $\mu$ s, 1 $\mu$ s, 10 $\mu$ s, 100 $\mu$ s, 1 ms Can be set up to 64 multiples.		
	Main functions that can be performed with the combination of main blocks		Pulse count, coincidence detection, cam switch, highly-accurate pulse output, PWM output, ratio setting, pulse measurement, electrical interface conversion		
	Processing time of the main hardware logic		Logic operation: min. 87.5 ns, coincidence output: min. 137.5 ns, cam switch: min. 262.5 ns		
	Module size allocation		2		
Occupied I/O points		32 points (I/O assignment: Intelligent 32 points)			
External interface		Two 40-pin connectors			
Internal power consumption (5 V DC)		A	0.66		
Weight		kg	0.18		
Dimensions (WxHxD)		mm	45x90x95		
Order information		Art. no.	296588		

## High-speed counter modules

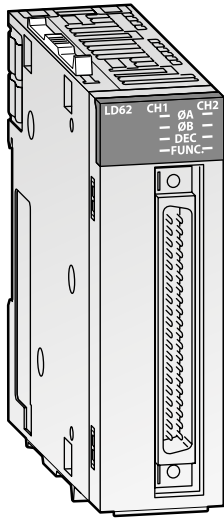

### Fast signal counting

The counter modules detect high-frequency signals, which cannot be handled by normal input modules.

### Special features:

- Periodic pulse counter function
- High-speed pulse measurement of up to 500 k pulses/s (LD62D)
- Linear and latch counter
- Ring counter function for counting up to a predefined value with automatic resetting to the start value
- Operation of integrated outputs when predefined count values are reached
- Easy configuration of the modules with GX Works2

Specifications		LD62	LD62D
Counter inputs (channels)		2	2
Count input signal	Phase	1-phase input (multiple of 1/2), CW/CCW, 2-phase input (multiple of 1/2/4)	
	Signal level	5/12/24 V DC (2–5 mA)	EIA standard RS422A differential type line driver
Max. counting frequency	kHz	200	500
Counting range		32 bits + sign (binary), -2147483648–2147483647	32 bits + sign (binary), -2147483648–2147483647
Max. counting speed	kHz	200, 100 or 10	500, 200, 100 or 10
Counting functions		UP/DOWN preset counter and ring counter	
Comparison range		32 bits + sign (binary)	
Comparison functions		Set value < counted value, set value = counted value, set value > counted value	
Connection terminal		40-pin connector	40-pin connector
External digital input points	Rated values	Preset, function start 5/12/24 V DC (2–5 mA)	5/12/24 V DC (2–5 mA) (RS422A)
	External digital output points (coincidence signal)	2 points/channel 12/24 V DC 0.5 A/point, 2.0 A/common (sink)	2 points/channel 12/24 V DC 0.5 A/point, 2.0 A/common (sink)
Occupied I/O points		16	16
Internal power consumption	mA	310	360
Weight	kg	0.13	0.13
Dimensions (WxHxD)	mm	28.5x90x95	28.5x90x95
<b>Order information</b>	Art. no.	238097	238098



## Interface modules

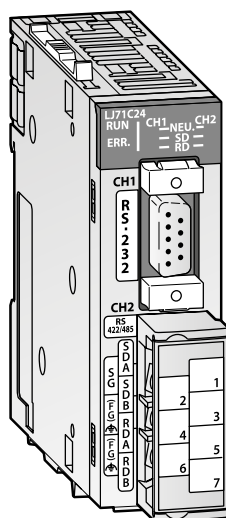

### Data exchange with peripheral devices

These modules enable communication with peripheral devices via a standard serial interface.

The LJ71C24 provides one RS232 and one RS422/485 interface and the LJ71C24-R2 provides two RS232 interfaces.

### Special features:

- Maximum transmission speed of 230.4 kbps
- Quick connection using pre-defined protocols included in GX Works2
- Easy to define custom protocols
- Enhanced debugging and support functions

Specifications		LJ71C24	LJ71C24-R2
Interface type	channel 1	RS232-compliance (D-Sub 9P female)	RS232-compliance (D-Sub 9P female)
	channel 2	RS422/485-compliance (2-piece terminal block)	RS232-compliance (D-Sub 9P female)
Communication mode		Full duplex/half duplex	
Synchronisation		Start-stop synchronization method	
Data transfer	Rate	50–230400, 115200 (with simultaneous operation of channel 1 and 2, and fault diagnosis by the monitor function)	
	Distance	RS232: 15; RS422/485: 1200	15
Network configuration		RS232: 1:1; RS422/485: 1:1, 1:n, n:1, m:n	1:1
Data format		1 start bit, 7 or 8 data bits, 1 or 0 parity bits, 1 or 2 stop bits	
Error detection		Parity check, checksum	
DTR/DSR and RS/CD control		RS232 enabled, RS422/485 disabled	
CD signal control		RS232 enabled, RS422/485 disabled	
X ON/X OFF (DC1/DC3), DC2/DC4		RS232 enabled, RS422/485 enabled	
Occupied I/O points		32	32
Internal power consumption		390	260
Weight		0.17	0.14
Dimensions (WxHxD)		28.5x90x95	28.5x90x95
Order information		Art. no. 238093	238094

■ Positioning modules

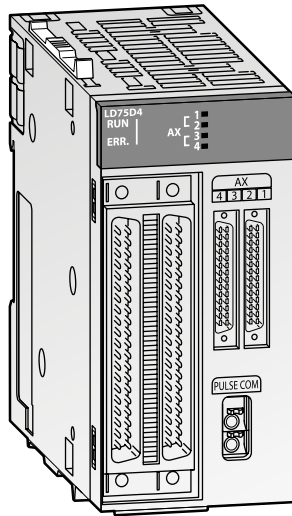

**Control of high resolution drives**

The L series offers two different positioning modules for control of up to four axes.

- Differential output type (LD75D1/2/4)
- Open-collector output type (LD75P1/2/4)

These positioning modules can be used with standard type servo amplifiers (Mitsubishi Electric MR-E, MR-J3/MR-J4).

All L series positioning modules can provide functionality such as interpolation, speed positioning operation etc.

The open-collector output type module provides positioning with open loop control. The module generates the travel command via the pulse chain. The speed is proportional to the pulse frequency and the distance travelled is proportional to the pulse length.

The modules with differential output can bridge large distances between the module and the drive unit, since this output enables long connection cables.

**Special features:**

- Up to 600 positioning data per axis
- Maximum output pulse of 200 k pulses/s for LD75P1/2/4 and 4 M pulses/s for LD75D1/2/4
- High-speed control of high resolution devices such as linear servos and direct drive motors
- Reduced machine vibration by using the optional acceleration/deceleration system
- Visualization of positioning module buffer data with customizable graphs

Specifications	LD75P1/LD75D1	LD75P2/LD75D2	LD75P4/LD75D4
Accessible axes	1	2	4
Output frequency	pulse/s	2-axis linear interpolation, 2-axis circular interpolation	2-/3-/4-axis linear interpolation, 2-axis circular interpolation
Positioning data items per axis	600		
Output type	Open collector/Differential driver	Open collector/Differential driver	Open collector/Differential driver
Output signal	Pulse chain	Pulse chain	Pulse chain
Positioning	Method	PTP (Point To Point) control, path control (both linear and arc can be set), speed control, speed-position switching control, position-speed switching control	
	Range	Absolute/incremental system: -214 748 364.8–214 748 364.7 μm -21 474.83648–21 474.83647 inch 0–359.99999 degree (absolute); 21 474.83648–21 474.83647 (incremental) -2 147 483 648–2 147 483 647 pulse	
		In speed-position switching control (INC mode)/position-speed switching control: 0–214 748 364.7 μm 0–21 474.83647 inch 0–21 474.83647 degree 0–2 147 483 647 pulse	
	Speed	1–1 000 000 pulse/s 0.01–20 000 000.00 mm/min 0.001–200 000.000 degree/min 0.001–200 000.000 inch/min	
	Acceleration/ deceleration processing	Automatic trapezoidal or S-pattern acceleration and deceleration or automatic S-pattern acceleration and deceleration	
	Acceleration/ deceleration time	1–83 88 608 ms (four patterns can be set for each of acceleration time and deceleration time)	
	Rapid stop deceleration time	1–8 388 608 ms	
Occupied I/O points	32		
Internal power consumption	mA	440/510	480/620
Weight	kg	0.18	0.18
Dimensions (WxHxD)	mm	45x90x95	
<b>Order information</b>	Art. no.	251446/251448	251447/251449
			238096/238095

## Simple Motion modules

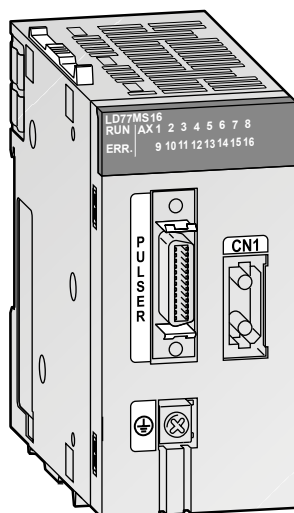

The MELSEC L series lineup includes a Simple Motion module in addition to the regular positioning modules. Various control functions previously only possible with Motion Controllers, such as speed control, torque control, synchronous control and cam control, are now available with the LD77MS module. These functions can be realized with simple parameter adjustments and via the PLC program.

Mark sensors allow use in packaging industry, filling plants, etc., without additional optional modules. A function for automatic calculation of cam data for applications with rotating cutters is implemented – only by setting the length of the product and the synchronisation path. With positioning functions, like linear interpolation (up to 4 axes), circular interpolation (2 axes) and path control it is easy to realize different applications, like X-Y tables, sealing, etc.

### Special features:

- Up to 600 positions per axis
- External encoder input for axis synchronisation
- Electronic cam control
- High-speed digital inputs for mark sensors to capture encoder position, motor position etc.
- Parameterization, programming, diagnostics and test operation by GX Works2
- PLCopen function blocks
- Communication between the LD77MS module and servo amplifiers via the high-speed network SSCNETIII/H

Specifications	LD77MS2	LD77MS4	LD77MS16
Number of controllable axes	2	4	16
Interpolation functions	2 axes linear and circular interpolation	Linear interpolation for up to 4 axes, circular interpolation for 2 axes	Linear interpolation for up to 4 axes, 2 axes linear and circular interpolation
Output type	SSCNETIII/H	SSCNETIII/H	SSCNETIII/H
Servo amplifier	MR-JE-B/MR-J4(W2/W3)-B over SSCNETIII/H	MR-JE-B/MR-J4(W2/W3)-B over SSCNETIII/H	MR-JE-B/MR-J4(W2/W3)-B over SSCNETIII/H
Operation cycle	0.88 ms	0.88 ms	0.88 ms/1.7 ms
Positioning	Method	PTP (Point To Point) control, path control (both linear and arc can be set), speed control, speed-position switching control, position-speed switching control, torque control	
	Acceleration/deceleration control	Trapezoidal or S-pattern acceleration and deceleration	
	Compensation	Backlash compensation, electronic gear, near pass function	
	OPR control	5 different methods	
Number of positioning points	600 per axis (can be set with GX Works2 or PLC program)		
External input signals	Encoder	1 encoder, A/B phases	1 encoder, A/B phases
	High-speed inputs	4 digital inputs [DI1–DI4]	4 digital inputs [DI1–DI4]
Cam function	Storage area cam data	256 kbytes	256 kbytes
	Number of cams	Max. 256 (depending on resolution)	Max. 256 (depending on resolution)
	Resolution per cycle	256, 512, 1024, 2048, 4096, 8192, 16384, 32768	256, 512, 1024, 2048, 4096, 8192, 16384, 32768
	Stroke resolution	2–16284	2–16284
Occupied I/O points	32	32	32
No. of Simple Motion modules in one system	max. 5	max. 5	max. 5
Internal power consumption (5 V DC)	mA 550	550	700
Weight	kg 0.22	0.22	0.22
Dimensions (WxHxD)	mm 90x45x95	90x45x95	90x45x95
<b>Order information</b>	Art. no. 268199	268200	268201

## Network modules

### Seamless integration of multiple networks

The MELSEC L series is part of a family of products all interconnected across various levels of automation. Based on the seamless message protocol (SLMP\*), data flows transparently between the sensor level and the management level across multiple industry-standard automation networks.

CC-Link IE, Asia's No. 1 industrial network, realizes fast gigabit data transmission speeds,

further optimizing the manufacturing cycle. In addition, digital link sensor AnyWireASLINK further enhance the factory-wide connectivity solution.

### Seamless communication

Seamless data communication through Ethernet, CC-Link IE Control, CC-Link IE Field, and CC-Link networks allow easy access to information, no matter where it resides on the network.

Through this technology, it is possible to "drill down" from the Enterprise or IT layer through multiple networks accessing programming controllers using GX Works2 programming or other related software.

In addition, many devices supporting SLMP\* such as vision sensors and RFID controllers may be connected to the CC-Link IE Field Network.

\* SLMP (SeamLess Message Protocol) is a protocol advocated by the CC-Link Partner Association.

4

MELSEC L series

### Ethernet interface module

Module	Specifications	Art. no.
LJ71E71-100	100 Mbps/10 Mbps, 10BASE-T/100BASE-TX, BACnet™ client function, MODBUS® TCP master function	263072

### AnyWireASLINK master module

Module	Specifications	Art. no.
LJ51AW12AL	Sensor-level network, master station, max. 200 m transmission distance:	290898

### CC-Link IE module

Module	Specifications	Art. no.
LJ61BT11	10 Mbps, master/local station, CC-Link dedicated cables compatible with Ver.1.10 (Ver.2.0)	238099

### SSCNETIII/H head module

Module	Specifications	Art. no.
LJ72MS15	150 Mbps, remote station (head module with END cover), SSCNETIII cable (optical fiber cable)	271040

### CC-Link/LT module

Module	Specifications	Art. no.
LJ61CL12	2.5 Mbps, master station, dedicated flat cable (0.75 mm <sup>2</sup> x 4), VCTF cable, flexible cable	284432

### Serial communication modules

Module	Specifications	Art. no.
LJ71C24	230.4 kbps, MODBUS® RTU master function	238093
LJ71C24-R2	230.4 kbps, MODBUS® RTU master function	238094

### CC-Link IE Field module

Module	Specifications	Art. no.
LJ71GF11-T2	1 Gbps, master/local station, Ethernet cable (Category 5e or higher, double shielded/STP)	246346

### CC-Link IE Field head module

Module	Specifications	Art. no.
LJ72GF15-T2	1 Gbps, remote station (head module with END cover), Ethernet cable (Category 5e or higher, double shielded/STP)	238100

## Serial communications adapters

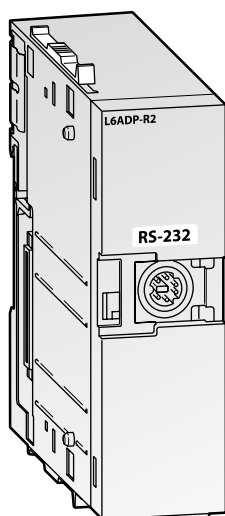

### RS232 and RS422/485 interface adapters

The L6ADP-R2 provides a RS232 and the L6ADP-R4 a RS422/485 interface for serial communication with the L series PLC.

Specifications	L6ADP-R2	L6ADP-R4
Application	Serial connection, e.g. GT10 Terminals	Serial connection, e.g. GOT Terminals
Power supply	Internally	Internally
Max. transfer rate Kpbs	115.2	115.2
Occupied I/O points	—	—
Internal power consumption mA	20	150
Weight kg	0.10	0.12
Dimensions (WxHxD) mm	28.5x90x95	28.5x90x106.5
<b>Order information</b>	Art. no. 238059	273657

## End cover

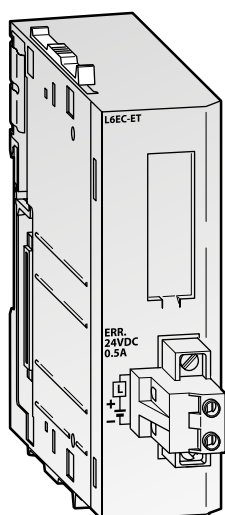

### END cover with error terminal

This end cover can be used instead of the standard end cover which comes with the CPU in the basic equipment.

The L6EC-ET end cover has a single relay output for error notification.

Specifications	L6EC-ET	L6EC
Application	Error notification via relay output	Standard end cover
Output	Screw terminal	—
Max. switching load A	0.5 (24 V DC)	—
Weight kg	0.11	0.06
Dimensions (WxHxD) mm	28.5x90x95	13x90x95
<b>Order information</b>	Art. no. 238062	249151

Note: L Series CPU modules are supplied with a standard End Cover L6EC.

**Accessories for the L series from page 114 onward!**

■ Power supply

L61P, L63P

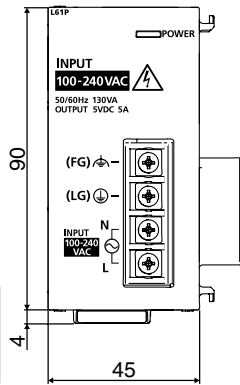
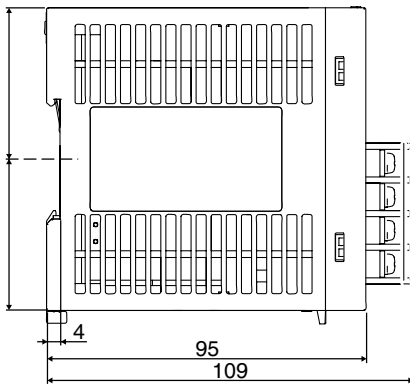

L63SP

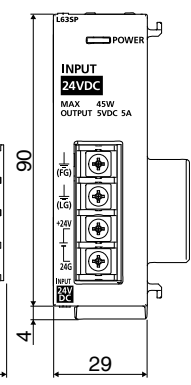
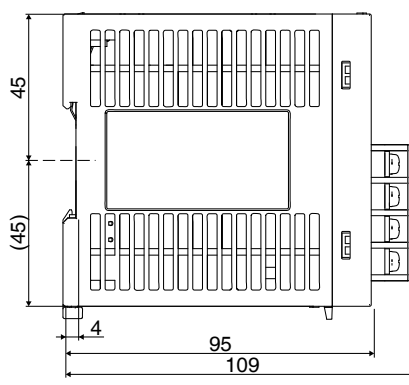

Unit mm

4

MELSECL series

■ CPU modules

L02SCPU, L02SCPU-P

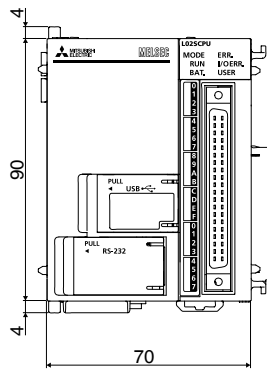
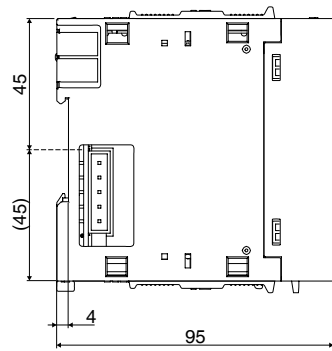

L02CPU, L02CPU-P, L06CPU, L06CPU-P, L26CPU, L26CPU-P

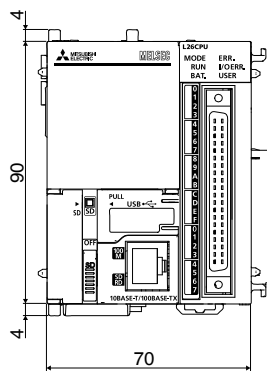
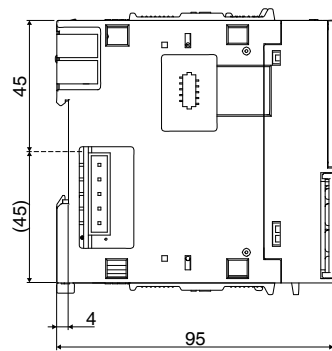

L26CPU-BT, L26CPU-PBT

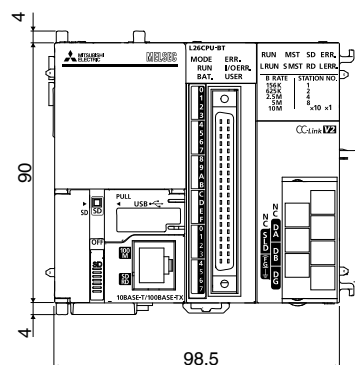
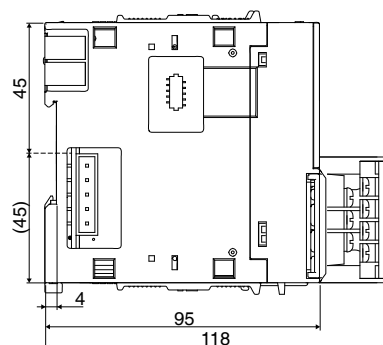

Unit mm

■ I/O modules, special function modules

LX40C6

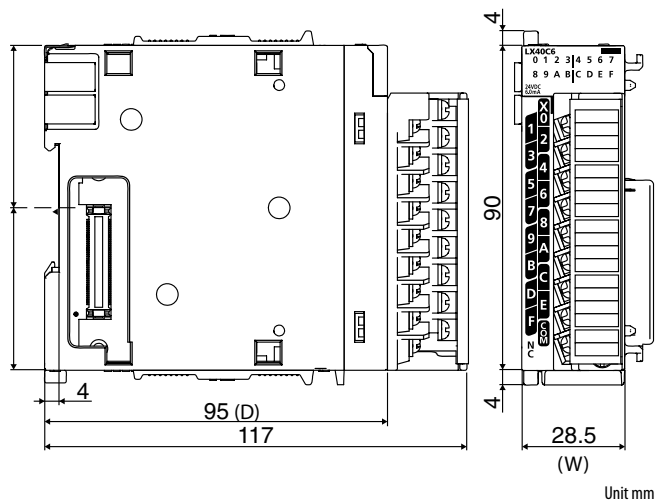

Type	Model name	WxHxD (mm)	
Digital input modules	LX41C4, LX42C4	28.5x90x95	
Digital output modules	LY40NT5P, LY41NT1P, LY42NT1P, LY40PT5P, LY41PT1P, LY42PT1P		
High-speed counter modules	LD62, LD62D		
Interface modules	LJ71C24, LJ71C24-R2		
Serial communications adapters	L6ADP-R2		
End cover	L6EC-ET, L6EC		
Flexible high-speed I/O control module	LD40PD01		45x90x95
Serial communications adapters	L6ADP-R4		28.5x90x106.5
Temperature input module	L60RD8		28.5x90x116.5
Digital input modules	LX40C6, LX10, LX28		28.5x90x117
Digital output modules	LY10R2, LY18R2A, LY28S1A, LY20S6		
IO-Link module	ME110L6-L		
Analog input modules	L60AD4, L60AD4-2GH, L60ADVL8, L60ADIL8		
Analog output modules	L60DA4, L60DAVL8, L60DAIL8		
Combined analog input/output module	L60AD2DA2		
Multiple input module	L60MD4-G		
Temperature control modules	L60TCT4, L60TCRT4, L60TCTT4BW, L60TCRT4BW		

■ Simple Motion and positioning modules

LD77MH4

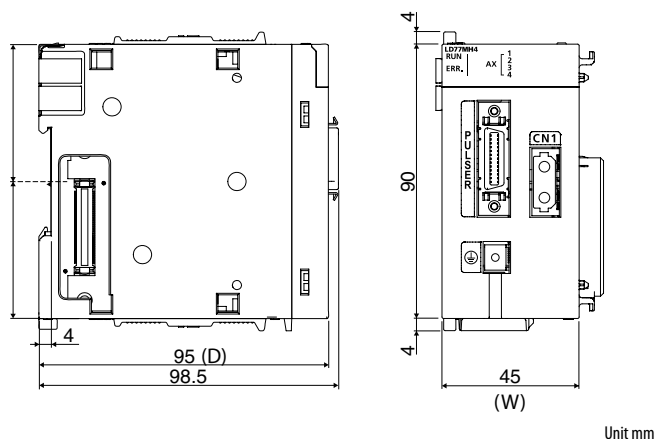

Type	Model name	WxHxD (mm)
Positioning modules	LD75P1/LD75D1, LD75P2/LD75D2, LD75P4/LD75D4	45x90x95
Simple Motion modules	LD77MS2, LD77MS4, LD77MS16	90x45x95

## Accessories for the MELSEC modular series

### Batteries

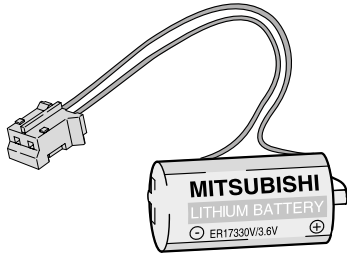

#### Buffer battery

The lithium battery Q6BAT is the replacement for the battery integrated for data backup in any MELSEC modular series.

iQ-R series  System Q  L series

The batteries Q7BAT and Q8BAT offer a larger capacity than the Q6BAT. Because of the also larger dimensions, these batteries are mounted externally of the CPU module.

Specifications		Q6BAT	Q7BAT	Q7BAT-SET	Q8BAT	Q8BAT-SET
Battery type	Replacement battery	Replacement battery	Replacement large-capacity battery	Large-capacity battery with holder for installing CPU	Replacement large-capacity battery module	Large-capacity battery module with CPU connection cable
Voltage	V DC	3.0	3.0	3.0	3.0	3.0
Capacity	mA h	1800	5000	5000	18000	18000
Dimensions	mm	16x30 (Ø x H)	27.4x30x60 (WxHxD)	27.4x30x60 (WxHxD)	55.2x98x87 (WxHxD)	55.2x98x87 (WxHxD) 1000 (cable)
<b>Order information</b>	Art. no.	130376	204127	204128	308746	296266

### DIN rail mounting adapters

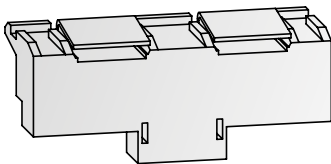
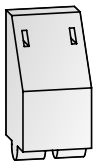

#### Adapter for mounting base units on a DIN rail

The mounting adapter is used for easy and quick mounting the MELSEC iQ-R and MELSEC System Q base units on a DIN rail.

iQ-R series  System Q  L series

The Q6DIN1A adapters for DIN rail mounting included with vibration-proofing brackets to improve resistance to vibration when mounting Q base unit to the DIN rail.

Specifications		R6DIN1	Q6DIN1	Q6DIN2	Q6DIN3	Q6DIN1A
Application	iQ-R	Main and extension base units	RQ68B/RQ612B	RQ65B	—	RQ extension base units (with vibration-proofing bracket sets)
	System Q	—	Q38B/Q312B/ Q68B/Q612B	Q35B/Q65B	Q33B/Q63B	Q3□□B, Q5□□B, Q6□□B, Q38RB, Q68RB and Q65WRB
Dimensions (WxH)	mm	—	328x98	245x98	198x98	—
<b>Order information</b>	Art. no.	279532	129673	129674	136368	308747

### Connection cables with connectors

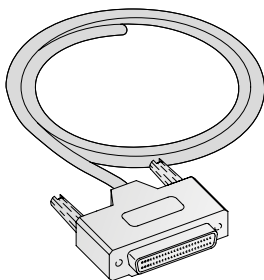

#### Assembled cables

The cables Q40CBL-3M and Q40CBL-5M serve as connecting cables for I/O modules with 40-pin plug connection.

The cables are prefabricated, i.e. a 40-pin connector is already attached to one cable end.

iQ-R series  System Q  L series

The cables FA-CBLQ75M□□ are ready made cables for the connection of the positioning modules QD75D1/D2/D4 or QD75P1/P2/P4 to a Mitsubishi Electric servo amplifier MR-J2-Super or MR-C.

Specifications		Q40CBL-3M	Q40CBL-5M	Q40CBL-10M	FA-CBLQ75M2J2-P	FA-CBLQ75M2C-P	FA-CBLQ75PM2J2	FA-CBLQ75PM2C
Application range		All MELSEC System Q modules with 40-pin connectors, like e.g. QX71, QX72, QY41P, QY42P, QX82(-S1)			QD75D1/D2/D4 for connection with MELSERVO MR-J2-S	QD75D1/D2/D4 for connection with MELSERVO MR-C	QD75P1/P2/P4 for connection with MELSERVO MR-J2-S	QD75P1/P2/P4 for connection with MELSERVO MR-C
Length	m	3.0	5.0	10.0	2.0	2.0	2.0	2.0
<b>Order information</b>	Art. no.	140991	140997	158068	147697	147698	147699	147700



## Accessories for the MELSEC modular series

### 37 and 40-pin connectors

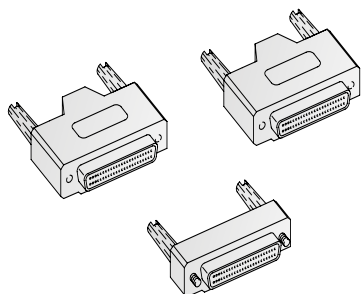

#### Connectors A6CON

These connectors are available in four different connection versions that differ in the way the leads are connected.

These connectors are required for all 32-point modules that connect to external signals via a 37-pin or 40-pin plug connection.

iQ-R series  System Q  L series

Whilst for the connectors A6CON1 to A6CON3 and A6CON1E to A6CON3E the cable is attached straight into the connector, in the case of the A6CON-4 the lead is angled.

Specifications	A6CON1	A6CON2	A6CON3	A6CON4
Connector	Soldering type	Crimp-contact type	Pressure displacement type	Soldering type
Applicable wire size	mm <sup>2</sup> 0.088–0.3	0.088–0.3	0.088 (flat cable)	0.088–0.3
Number of pins	40	40	40	40
<b>Order information</b>	Art. no. 134139	134140	134141	146923

### Wireless LAN adapter

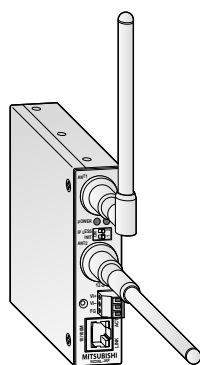

#### Wireless connection to networks

With the wireless LAN adapter NZ2WL-EU, a PLC system can be wirelessly connected to a network (LAN). This shortens the configuration and connection process at end-user facilities.

iQ-R series  System Q  L series

The adapter complies to directives IEEE 802.11 a / b / g and can be configured as an access point or station.

Specifications	NZ2WL-EU	
Wired LAN	Communications speed	10/100 Mbit/s
	Communications mode	Half duplex/full duplex
	Number of interfaces	1 (10BASE-T/100BASE-TX)
1 (10BASE-T/100BASE-TX)	Transmission method	Conforms to IEEE802.11 a/b/c
	Communications speed	1–54 Mbit/s
External power consumption	Voltage	12–24 V DC
	Current	Max. 0.4 A at 12 V DC, max. 0.2 A at 24 V DC
Dimensions (without aerial) (WxHxD)	mm	25x97x68
Weight	kg	0.25
<b>Order information</b>	Art. no.	249090

## Accessories for the MELSEC modular series

### Industrial switching HUB

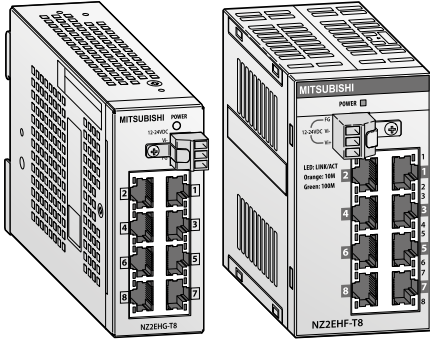

NZ2EHG-T8

NZ2EHF-T8

NZ2EHG-T8 and NZ2EHF-T8 are compact-sized industrial switching HUB units with 8 ports capable of 1000BASE-T.

The model NZ2EHF-T8 may not be connected directly to the CC-Link IE Field Network (1 Gbps). An Ethernet adapter module NZ2GF-ETB (see below) is required. For direct use with the CC-Link IE Field Network, please use NZ2EHG-T8.

☑ iQ-R series ☑ System Q ☑ L series

**Special features:**

- Auto MDI/MDI-X feature, auto-negotiation feature
- Automatic power adjusting function
- Flexible installation orientation
- Capable of running on a wide range of input voltages (12 to 24 V DC)
- Quick detach mechanism allows easy DIN rail attachment and detachment.

Specifications	NZ2EHG-T8	NZ2EHF-T8
Ethernet standards	IEEE802.3/IEEE802.3u/IEEE802.3ab-compliant	IEEE802.3/IEEE802.3u-compliant
Data communication rate	10/100/1000 Mbps (auto-recognition)	10/100 Mbps (auto-recognition)
Number of effective ports	8	8
<b>Order information</b>	Art. no. 259221	259222

### Ethernet adapter module

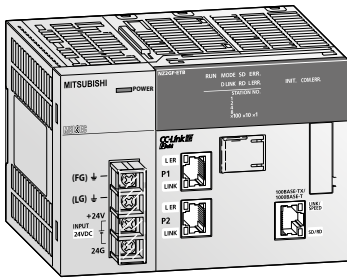

The Ethernet adapter module connects external devices on the Ethernet network to the CC-Link IE Field Network.

☑ iQ-R series ☑ System Q ☑ L series

- Connection to MELSOFT products or GOTs
- CC-Link IE Field Network diagnostics
- Ethernet adapter diagnostics

**Special features:**

- Communication using SLMP
- Connection of MC protocol devices

Specifications	NZ2GF-ETB
Transmission rate:	100 Mbps/1 Gbps
<b>Order information</b>	Art. no. 253007

## MELSEC iQ-R series

### SD memory cards

iQ-R series  System Q  L series



#### MELSEC iQ-R memory cards

In MELSEC iQ-R CPU modules SD memory card can be used for logging data, troubleshooting device values or as a memory database for recipe storage

Specifications		NZ1MEM-2GBSD	NZ1MEM-4GBSD	NZ1MEM-8GBSD	NZ1MEM-16GBSD
Memory type	SD	SDHC	SDHC	SDHC	SDHC
Memory capacity		2 GB	4 GB	8 GB	16 GB
<b>Order information</b>	Art. no.	284966	284967	284968	284969

### Extended SRAM cassettes

iQ-R series  System Q  L series

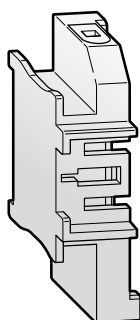

An optional SRAM cassette enables device/label memory to be increased and doubling up as a hardware security key.

Specifications		NZ2MC-1MBS	NZ2MC-2MBS	NZ2MC-4MBS	NZ2MC-8MBS	NZ2MC-8MBSE	NZ2MC-16MBS
Memory type	SRAM	SRAM	SRAM	SRAM	SRAM	SRAM	SRAM
Memory capacity		1 MB	2 MB	4 MB	8 MB	8 MB	16 MB
<b>Order information</b>	Art. no.	283684	283683	283682	283583	285495	311472

### Connection cables

iQ-R series  System Q  L series

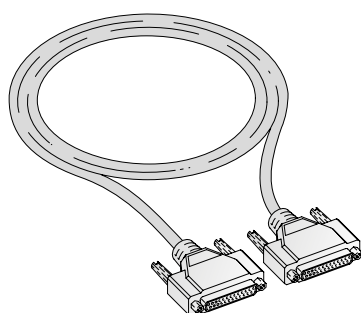

#### Connection cable for extension units

These connection cables are used for connecting base units to the extension units. They have been cut to the correct length for each application.

When the extension cables are used multiple, the overall distance of the cables should be within 20 m (13.2 m with RQ extension base).

Specifications		RC06B	RC12B	RC30B	RC50B
Application		RQ extension base units	RQ extension base units	RQ extension base units	RQ extension base units
Length	m	0.6	1.2	3	5
<b>Order information</b>	Art. no.	279528	279529	279530	279521

### Blank cover modules

iQ-R series  System Q  L series

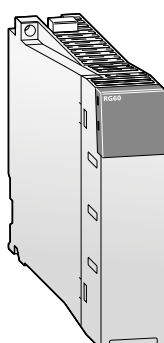

The blank cover module is used for dust prevention in the space where an I/O module is not mounted (especially the empty slot between modules).

Specifications		RG60	QG60
Application		I/O slots of main and extension base units	I/O slots of RQ extension base units
Occupied I/O points		16	16
Weight	kg	0.07	0.07
Dimensions (WxHxD)	mm	27.8x106x110	27.8x106x110
<b>Order information</b>	Art. no.	279555	129853

## MELSEC System Q

### ■ Dummy module

iQ-R series  System Q  L series

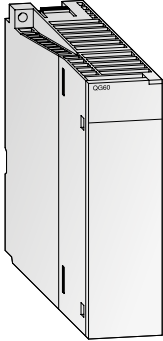

#### Place holder and mechanical protection

The dummy module QG60 protects unused slots on the base unit from dust and reserves I/O addresses.

#### Special features:

- Tough protection of unused slot
- Unified front view

Specifications	QG60	
Occupied I/O points	0–1024 (selectable)	
Application	Used to protect any vacant slot from dust.	
Current consumption	mA	—
Weight	kg	0.07
Dimensions (WxHxD)	mm	27.4x98x90
<b>Order information</b>	Art. no.	129853

5

Accessories

### ■ ERNT – conversion adapters

iQ-R series  System Q  L series

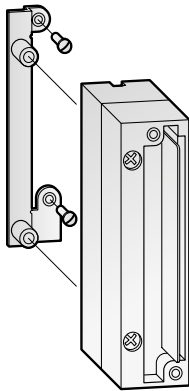

#### AnS series adapters -> MELSEC System Q

These adapters enable a PLC of the MELSEC AnS series to be easily replaced by a MELSEC System Q PLC.

The terminal block adapters enable existing wiring for modules of the MELSEC AnS series to be connected to MELSEC System Q modules. The mounting adapters enable a MELSEC System Q base unit to be fitted using the existing fixing holes of the MELSEC AnS series.

#### Special features:

- No changes to wiring when replacing the PLC
- Time savings and fewer error sources
- Using the existing fixing holes avoids mechanical work in the electrical cabinet.

Item	Application	Art. no.
ERNT-ASQTX10	Terminal block A1SX10/A1SY10 to QX10/QY10	249093
ERNT-ASQTX40	Terminal block A1SX40(-S1/S2) to QX40(-S1)	249094
ERNT-ASQTX80	Terminal block A1SX80(-S1/S2) to QX80	249135
ERNT-ASQTY22	Terminal block A1SY22 to QY22	249136
ERNT-ASQTY40	Terminal block A1SY40(P) to QY40P	249137
ERNT-ASQTY50	Terminal block A1SY50 to QY50	249138
ERNT-ASQTY80	Terminal block A1SY80 to QY80	249139
ERNT-ASQT64AD	Terminal block A1S64AD to Q64AD	249140
ERNT-ASQT68AD	Terminal block A1S68AD to Q68AD(V/I)	249141
ERNT-ASQT62DA	Terminal block A1S62DA to Q62DAN	249142
ERNT-ASQT68DA	Terminal block A1S68DA(V/I) to Q68DA(V/I)N	249143
ERNT-ASQB38	Base unit A1S38(H)B to Q38B	249144
ERNT-ASQB35	Base unit A1S35B to Q35B	249145
ERNT-ASQB33	Base unit A1S33B to Q33B	249146
ERNT-ASQB00J	Base unit A1SJ(H)CPU(-S3) to Q00(U)CPU	249147
ERNT-ASQB68	Base unit A1S68B to Q68B	249148
ERNT-ASQB65	Base unit A1S65B to Q65B	249149
ERNT-ASQB55	Base unit A1S55B to Q55B	249150

### ■ PCMCIA adapter unit

iQ-R series  System Q  L series

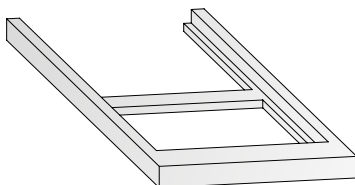

#### Memory card adapter

The memory card adapter Q2MEM-ADP is used for the PCMCIA slot of the PLC for data transferring.

Specifications	Q2MEM-ADP	
For memory cards	type	All MELSEC Q memory cards
<b>Order information</b>	Art. no.	129650

## MELSEC System Q

### ■ Connection cables

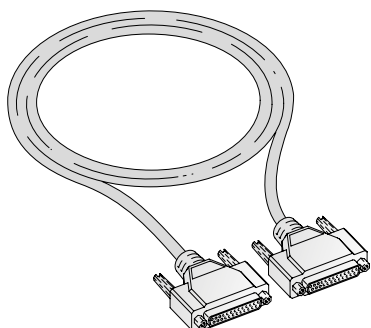

#### Connection cable for extension units

These connection cables are used for connecting base units to the extension units. They have been cut to the correct length for each application.

iQ-R series  System Q  L series

When the extension cables are used multiple, the overall distance of the cables should be within 13.2 m.

Specifications	QC05B	QC06B	QC12B	QC30B	QC50B	QC100B
For extension base units	Q52B, Q55B	Q63B, Q65B, Q68B, Q612B	Q63B, Q65B, Q68B, Q612B	Q63B, Q65B, Q68B, Q612B	Q63B, Q65B, Q68B, Q612B	Q63B, Q65B, Q68B, Q612B
Length	m 0.45	0.6	1.2	3.0	5.0	10.0
<b>Order information</b>	Art. no. 140380	129591	129642	129643	129644	129645

### ■ Tracking cables

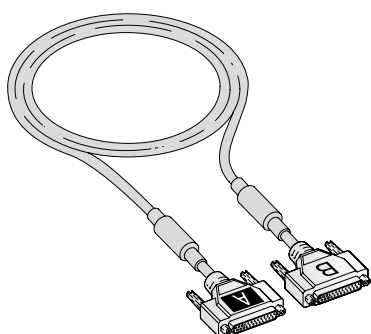

#### Connection cable for redundant CPUs

The tracking cable connects the two CPUs in a redundant system. Use only the QC10TR or QC30TR cables!

The connectors of the tracking cables are labelled A and B for System A and System B.

iQ-R series  System Q  L series

When both systems are started at the same time System A will be the active controller and System B will be the standby system.

The length of the extension cables cannot exceed 13.2 metre

Specifications	QC10TR	QC30TR
Purpose	Connection of the two CPU modules in a redundant system (QnPRHCPU)	
Length	m 1.0 m	3.0 m
<b>Order information</b>	Art. no. 157068	157069

### ■ Programming cables

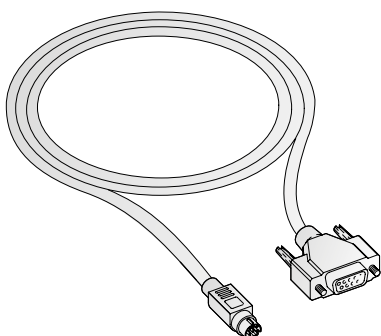

#### Programming cable for USB and RS232 interface

The QC30R2 and QC30-USB cables are used for programming a MELSEC System Q CPU via the RS232 and standard USB ports.

The programming cable provides a 9-pin D-sub connector for the PC side and a 6-pin Mini-DIN connector for the PLC interface.

iQ-R series  System Q  L series

The USB cable is especially suited for a fast connection between PC and CPU.

Specifications	QC30R2	QC30-USB	USB-CAB-5M
Connection cable for	Connection between a PCs and a MELSEC System Q PLC via RS232 interface	Connection of a PC to a MELSEC System Q CPU via a standard USB port	Connection of a PC to an iQ CPU in the MELSEC System Q via a mini-USB port
Length	m 3.0	3.0	5.0
<b>Order information</b>	Art. no. 128424	136577	221540
Accessories	Connector disconnection prevention holder Q6HLD-R2	—	—

## MELSEC System Q

### Connector disconnection prevention holder

iQ-R series  System Q  L series

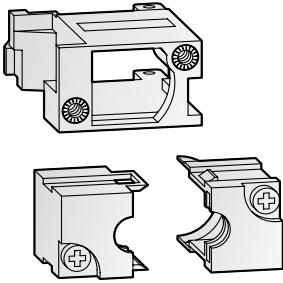

#### Disconnection prevention for RS232 cable

The connector disconnection prevention holder Q6HLD-R2 securely locks the RS232 connector of the programming cable to the CPU and prevents

the connector from accidentally loosening (e.g. when connected to an HMI operator terminal).

Specifications		Q6HLD-R2	
Application		Programming cable QC30R2	
Order information	Art. no.	140381	

5

### Adapter cables

iQ-R series  System Q  L series

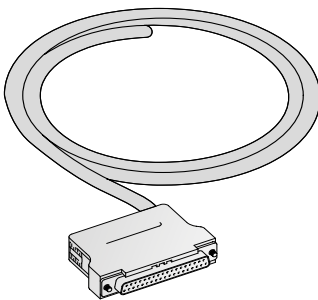

#### Assembled cable with D-SUB plug

The cables Q32CBL-3M and Q32CBL-5M are used for connecting the modules QX81 and QY81P of the MELSEC Q.

Specifications		Q32CBL-3M	Q32CBL-5M	Q32CBL-10M
Connection cable for	type	QX81/QY81P	QX81/QY81P	QX81/QY81P
Length	m	3.0	5.0	10.0
Order information	Art. no.	136575	136576	158066

### Memory cards

iQ-R series  System Q  L series

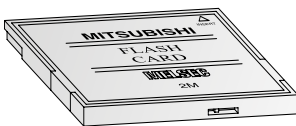

All MELSEC System Q CPUs have a permanently installed RAM. This memory can be extended with a variety of external memory cards.

Specifications		Q2MEM-1MBS	Q2MEM-2MBS	Q2MEM-2MBF	Q2MEM-4MBF	Q2MEM-8MBA	Q2MEM-16MBA	Q2MEM-32MBA
Memory	type	SRAM	SRAM	Flash	Flash	ATA	ATA	ATA
Memory capacity		1 MB	2 MB	2 MB	4 MB	8 MB	16 MB	32 MB
Order information	Art. no.	127627	145399	127591	129646	129647	129648	129649

Specifications		Q3MEM-4MBS	Q3MEM-4MBS-SET	Q3MEM-8MBS	Q3MEM-8MBS-SET
Memory	type	SRAM	SRAM	SRAM	SRAM
Memory capacity		4 MB	4 MB	8 MB	8 MB
Order information	Art. no.	217621	217622	217623	217624

Accessories		Q3MEM-CV: Memory card protective cover for the Universal model QCPU (comes with Q3MEM-4MBS-SET/Q3MEM-8MBS-SET) Q3MEM-CV-H: Memory card protective cover for the High Performance model, Process, and Redundant CPUs (comes with Q3MEM-4MBS-SET)
-------------	--	--

Specifications		NZ1MEM-2GBSD	NZ1MEM-4GBSD	NZ1MEM-8GBSD	NZ1MEM-16GBSD
Memory	type	SD	SDHC	SDHC	SDHC
Memory capacity		2 GB	4 GB	8 GB	16 GB
Order information	Art. no.	284966	284967	284968	284969

## MELSEC System Q

### Extended SRAM cassettes

iQ-R series  System Q  L series

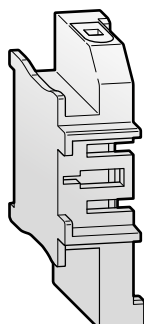

An optional SRAM cassette enables device/label memory to be increased and doubling up as a hardware security key.

Specifications	Q4MCA-1MBS	Q4MCA-2MBS	Q4MCA-4MBS	Q4MCA-8MBS
Memory capacity	1 MB	2 MB	4 MB	8 MB
<b>Order information</b>	Art. no. 266134	266155	266156	266157

### SRAM card batteries

iQ-R series  System Q  L series



#### Memory card buffer battery

The lithium battery Q2MEM-BAT is a replacement battery for the SRAM memory card Q2MEM-1MBS.

Specifications	Q2MEM-BAT	Q3MEM-BAT
For memory card	type Q2MEM-1MBS and Q2MEM-2MBS	Q3MEM-4MBS and Q3MEM-8MBS
Voltage	V DC 3.0	3.0
Capacity	mA h 48	550
<b>Order information</b>	Art. no. 129854	236259

### Interchangeable terminal blocks for I/O modules

iQ-R series  System Q  L series

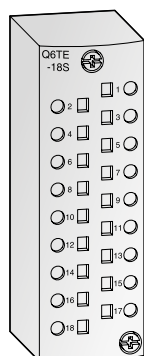

#### Terminal blocks for screw-less wiring

As an alternative to the standard screw terminal blocks for the input/output modules, there are three different screw-less terminal blocks available.

The spring clamp terminal blocks Q6TE-18S and Q6TE-18SN permit the connection of single or multiple-wire copper conductors, whereby the stripped cable ends are pressed vertically into the terminal and are held by a traction spring.

In the case of the Q6TA32 terminal block, contact is made by pressing in the wire with the optional insertion tool without having to strip the wire first. This allows for rapid wiring of the terminals.

Specifications	Q6TE-18S	Q6TE-18SN	Q6TA32
Type	Spring clamp terminal block	Spring clamp terminal block	IDC terminal block adapter
Applicable modules	All MELSEC System Q modules with terminal block for 18 screw terminals		QX41, QX71, QY41P, QY71
Applicable wire size	mm <sup>2</sup> 0.3–1.5	0.3–1.5	0.5
Weight	kg 0.07	0.07	0.08
<b>Order information</b>	Art. no. 141646	249089	145034
Accessories	—	—	Insertion tool Q6TA32TOL, art. no.: 145035

## MELSEC L series

### ■ Display module

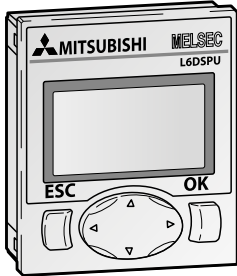

The display module allows to check the system status and to make setting changes directly from the display, which will be built-in directly into the CPU.

iQ-R series  System Q  L series

Error status is clearly identified and troubleshooting and error investigation can be performed all without the need for any connections or engineering software.

Specifications	L6DSPU	
Application	Displaying menus, time, and monitoring data. Setting of values and parameters.	
Display	16 letters x 4 lines	
Power supply	From CPU	
Display	LCD with backlight (green/red)	
Language	English, Japanese	
Dimensions (WxHxD)	mm	45x50x17.3
<b>Order information</b>	Art. no.	238058

5

Accessories

### ■ SD memory cards



The SD memory card allows quick and easy back-up of the CPU program and parameters. It can also be used to hold data captured with the data logging function.

iQ-R series  System Q  L series

The card is selectively available with 2 GB and 4 GB capacity.

Specifications	L1MEM-2GBSD	L1MEM-4GBSD
Card type	SD memory card	SDHC memory card
Memory capacity	2 GB	4 GB
<b>Order information</b>	Art. no.	238060
		238061

### ■ Branch/extension module

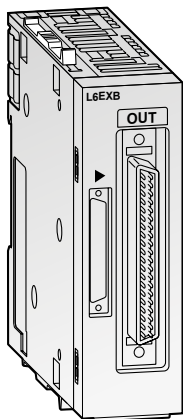

#### Extension for MELSEC L series PLC

With a L6EXB branch module, which is connected to the CPU, and with up to two (L02CPU, L02CP-P) or up to three extension modules

iQ-R series  System Q  L series

(L26CPU-BT, L26CUPBT), a MELSECL series PLC can be extended to max. 30/40 modules.

Specifications	L6EXB [Branch module]	L6EXE [Extension module]
Internal power consumption (5 V DC)	A 0.08	0.08
Weight	kg 0.12	0.13
Dimensions (WxHxD)	mm 28.5x90x95	28.5x90x95
<b>Order information</b>	Art. no.	247227
		247226



## MELSEC L series

### Space module

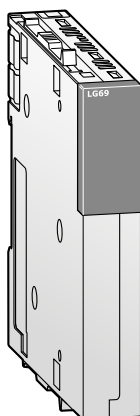

The space module LG69 is used to secure space for the cables when replacing the AnS/QnAS Series system to the L series system module. Cables can be stored in an area created by a space module, and this space prevents cables from interfering each other.

iQ-R series  System Q  L series

The space module enables system replacement while reusing the existing wiring, reducing the rewiring work.

Specifications	LG69	
Number of occupied modules	The number of occupied modules may vary depending on the modules to be used.	
Weight	kg	0.07
Dimensions (WxHxD)	mm	16.5x90x95
<b>Order information</b>	Art. no.	279073

### Extension cables

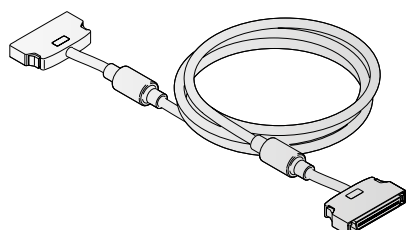

#### Connection between branch module and extension module

These cables connects a branch module with one or two extension modules.

iQ-R series  System Q  L series

Specifications	LC06E	LC10E	LC30E	
Cable length	m	0.6	1.0	3.0
Weight	kg	0.19	0.23	0.45
<b>Order information</b>	Art. no.	247228	247229	247230

### Spring clamp terminal block (push-in type)

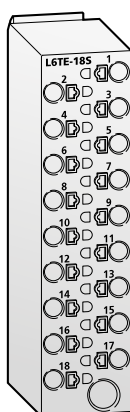

The screw terminal block of installed modules can be replaced with a push-in type spring clamp terminal block.

This terminal block type helps to reduce the amount of wiring and maintenance time.

iQ-R series  System Q  L series

#### Special features:

- Push-in type for reduced wiring
- Simple to confirm signal integrity

Specifications	LGTE-185	
Type	18-point spring clamp terminal block	
Applicable wire size	mm <sup>2</sup>	0.3–1.0 mm <sup>2</sup> (22–18 AWG)
Dimensions (WxHxD)	mm	20x76.8x20
<b>Order information</b>	Art. no.	277553

## MELSOFT – Programming and documentation software for standard personal computers



With the MELSOFT software family Mitsubishi Electric offers efficient software packages helping to reduce programming and setup times to a high degree.

The MELSOFT software family provides instant access, direct communications, compatibility, and open exchange of variables.

The MELSOFT family comprises:

- Programming packages like GX Works2 and GX Works3
- Visualization software like for example MAPS
- Network configuration software like for example GX Configurator DP and GX Configurator PN
- Various development software for operator terminals GT Works3 and GT SoftGOT1000

GX Works2 and GX Works3 is recommended as a cost-effective beginners package for the MELSEC System Q. This package offers a quick and easy introduction to programming.

For structured programming the IEC 1131 (EN 61131) conform programming software GX IEC Developer is recommended.

### ■ Unified engineering environment: iQ Works

iQ Works integrates the functions necessary to manage every part of the system cycle.

#### System design

The intuitive system configuration diagram allows for the graphic assembly of systems, centralized management of disparate projects and batch configuration of the entire control system.

#### Programming

Use system labels to seamlessly share device data between GOTs, PLCs and motion controllers. Save the time and hassle of changing device values in each program by using the update system labels feature.

#### Test and startup

Debug and optimize programs using the simulation functions. Use the included diagnostics and monitoring functions to quickly identify the source of errors.

#### Operation and maintenance

Speed up the process of commissioning, configuring and updating the system by using the batch read feature. Virtually eliminate the confusion associated with system management.

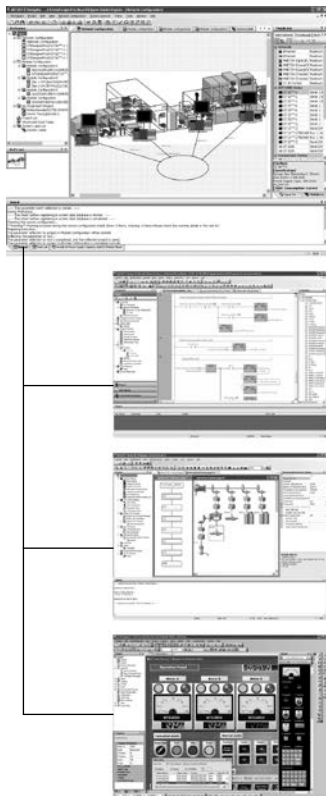

#### MELSOFT Navigator

is the heart of iQ Works. It enables the effortless design of entire upper-level systems and seamlessly integrates the other MELSOFT programs included with iQ Works. Functions such as system configuration design, batch parameter setting, system labels and batch read all help to reduce TCO.

#### MELSOFT GX Works

represents the next generation in MELSOFT PLC maintenance and programming software. Its functionality has been inherited from both GX and IEC Developer, with improvements made throughout to increase productivity and drive down engineering costs.

#### MELSOFT MT Works

is a comprehensive motion CPU maintenance and program desing tool. Its many useful functions, such as intuitive settings, graphical programming and digital oscilloscope, simulator, different Motion OS support, assistance help, to reduce the MT Works2 associated with motion systems.

#### MELSOFT GT Works

is a complete HMI programming, screen creation and maintenance program. In order to reduce the labor required to create detailed and impressive applications, the software's functionality has been built around the concepts of ease of use, simplifications (without sacrificing functionality) and elegance (in design and screen graphics).

## GX Works



GX Works3 is the programming and configuration software for iQ-F and iQ-R controllers. GX Works2 is the programming and configuration software for FX, L, and Q series controllers. Following the goal of maximum efficiency, GX Works2 & GX Works3 conform to IEC61131-3 standards, allowing developers to mix and match between five different programming languages and save parts of projects in libraries for use within future applications.

- Integrated parameterization of special function modules (analog, temperature, positioning, counter, network)

- Use of program and function block libraries save time for programming and minimizes errors.
- Integrated simulation allows offline testing of the software and the configuration.
- Comprehensive diagnostics and debugging functions support the user in troubleshooting and fault clearance.
- Revision verification and restoration makes it possible to restore old program versions or to compare with programs from the PLC.
- GX Works is compatible with GX Developer and GX IEC Developer projects (as far as the editors are supported)

Software	GX Works2 V01-2LOC-E	GX Works2 V01-5LOC-E	GX Works2 V01-2LOC-E-UPGRADE	GX Works2 V01-5LOC-E-UPGRADE	GX Works3 V01-2LOC-E	GX Works3 V01-5LOC-E	GX Works3 V01-2LOC-G	GX Works3 V01-5LOC-G	GX Works3 V01-2LOC-IT	GX Works3 V01-5LOC-I	
Series	FX series, L series and Q series				All						
Language	English – consult with local Mitsubishi Electric representative for German and Italian versions.				English		German		Italian		
Order information	Art. no.	234630	234631	234632	234634	284378	284379	304614	304645	308856	308857

## Software for process visualisation and for dynamic data exchange

### MX OPC Server

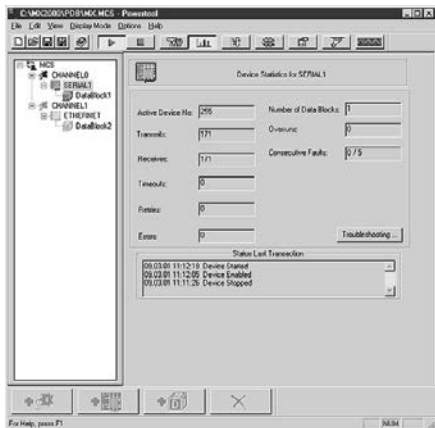

The OPC standard was developed for manufacturer independent communications between processes and Microsoft Windows® applications in client/server architecture.

OPC means “OLE for Process Control” and represents an application of the Microsoft DCOM technology (Distributed Component Object Model). In contrast to Active-X the OPC

based data exchange especially features a higher performance.

The MX OPC server is a standardized software interface that enables Microsoft Windows® applications to access a Mitsubishi Electric PLC quick and easily.

MX OPC Server can be run under MS Windows® XP and Vista.

Software	MX OPC Server V0600-1LOC-E	MX OPC Server UA V201-1LOC-E	
Series	All MELSEC PLCs	All MELSEC PLCs	
Language	English	English	
Disk type	CD ROM	CD ROM	
Order information	Art. no.	221608	282994

### MX Components

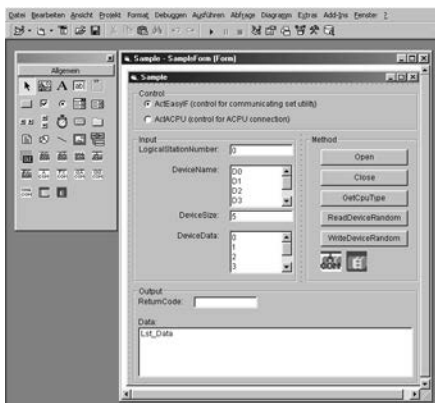

This software provides you with powerful Active-X elements. An internal driver manages the complete communications between your Microsoft Windows® application and your process. Via MX components and a programming language (e.g. Visual Basic, Visual C++, etc.) you can easily create your own PC applications or integrate existing PC applications.

Moreover, via MX Components and VBA the complete MS Office range is at your service. Without high effort you can integrate online process data of a Mitsubishi Electric PLC in your existing office software (e.g. MS Access or MS Excel etc.).

MX Components can be run under MS Windows® XP and Vista.

Software	MX Components V0300-1LOC-E	
Series	All MELSEC PLCs	
Language	English	
Disk type	CD ROM	
Order information	Art. no.	145309

## Software for Profibus networks

### ■ GX Configurator DP



The Software GX Configurator DP is a user friendly configurations software for the open network Profibus DP.

The software package is a 32 bit application and runs under MS Windows® XP and Vista. Configuration of all Profibus modules for the MELSEC System Q, AnSH/QnAS series and also the FX family is possible.

Due to the supported extended user parameters of a GSD file, easy parameter setting of Profibus DP slave devices is possible even for third party devices.

The new GX Configurator DP enables the download of all configuration data via an overriding network.

Software		GX Configurator DP V07-1LOC-M	
Supported Profibus DP master modules for the Mitsubishi Electric MELSEC series		A1S1J71PB92D, QJ71PB92D, QJ71PB92V, QJ71PB91V	
Language		English/German	
Version		7.13	
Order information		Art. no.	231731
Accessories		Programming cable QC30R2, art. no.: 128424; QC30-USB, art. no.: 136577	

6

Programming

### ■ GX Configurator PN

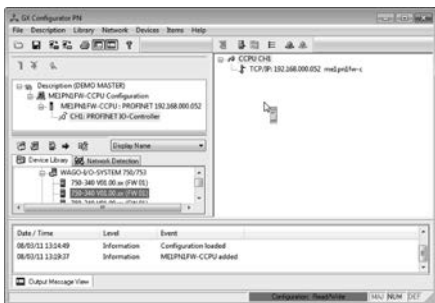

GX Configurator PN is the configuration tool for Profinet I/O modules. This software offers functions for the configuration of the Profinet I/O network, testing the configuration and transfer of the settings to the Profinet module.

When transferring the parameter data, GX Configurator PN offers a variety of capabilities. The Profinet module can be on the base

unit, where the PC is connected directly or also in another PLC within the network.

Profinet I/O slave devices are configured by GSD files, which are provided by the device manufacturers.

Software		GX Configurator PN V01-1LOC-E	GX Configurator PN V02-1LOC-E*
Supported Profinet module for the Mitsubishi Electric MELSEC series		ME1PN1FW-CCPU (System Q)	RJ71PN92 (iQ-R)
Language		English	English
Version		1.02	2.00
Order information		Art. no.	255245
			308831

\* Please confirm with local Mitsubishi Electric representative for product availability



**Accessories**

MELSEC iQ-R series .....	117
MELSEC L series .....	122
MELSEC modular series .....	116
MELSEC System Q .....	118

**MELSEC iQ-R series**

Accessories .....	114
Basic components	
Base units .....	17
CPU modules .....	19
Power supply modules .....	18
Digital modules	
Combined I/O module .....	28
(High-speed) input modules .....	24
(High-speed) output modules .....	26
Dimensions .....	42
Special function modules	
Analog modules .....	29
C intelligent function module .....	41
High-speed counter modules .....	33
High-speed data logger module .....	40
Interface modules .....	36
iQ-R C-Application server .....	39
MES Interface module .....	38
Network modules .....	37
Positioning modules .....	34
Simple Motion modules .....	35
Temperature control modules .....	32
System description .....	16

**MELSEC L Series**

Accessories .....	114
Basic components	
CPU modules .....	95
Power supply modules .....	94
Digital modules	
Input modules .....	96
Output modules .....	97
Dimensions .....	112
Special function modules	
Analog modules .....	99
End Cover .....	111
Flexible high-speed I/O control module .....	105
High-speed counter modules .....	106
Interface modules .....	107
IO-Link module .....	98
Multiple input module .....	102
Network modules .....	110
Positioning modules .....	108
Serial communication adapter .....	111
Simple motion modules .....	109
Temperature control modules .....	104
Temperature input module .....	103
System description .....	92

**MELSEC System Q**

Accessories .....	114
Basic components	
Base units .....	50
CPU modules .....	53
Power supply module .....	52
Digital modules	
Input modules .....	60
Output modules .....	62
Dimensions .....	88
Special function modules	
Analog CT input module .....	71
Analog modules .....	64
High-speed communication modules .....	81
High-speed counter modules .....	73
High speed data logger module .....	86
Interface modules .....	80
Interrupt module and high-speed inputs .....	87
Load cell module .....	70
Loop control module .....	72
MES Interface module .....	84
Multi-function counter/timer module .....	74
Network modules .....	82
Positioning modules .....	75
Q series C-Application server .....	85
Simple Motion modules .....	79
Temperature control modules .....	69
Web server module .....	83
System description .....	45
Automation platform .....	45
Configuration .....	48
Module combinations for multiple CPU system .....	49
Safety .....	46

**Modular PLCs**

Equipment features .....	8
iQ Platform .....	9
Overview .....	6
Special functions	
MELSEC iQ-R .....	10
MELSEC L series .....	14
MELSEC System Q .....	12

**Programming**

GX Works .....	125
iQ Works .....	124
MELSOFT Software .....	124
Profibus software .....	126
Visualisation software .....	125

# Your solution partner

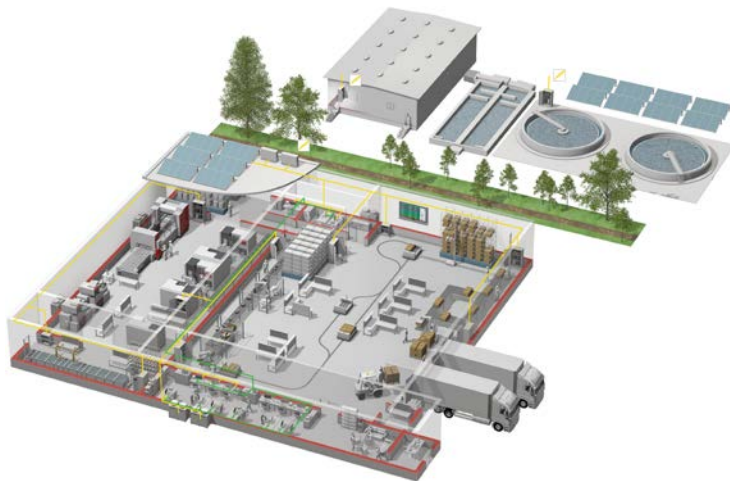

Mitsubishi Electric offers a wide range of automation equipment from PLCs and HMIs to CNC and EDM machines

## A name to trust

Since its beginnings in 1870, some 45 companies use the Mitsubishi name, covering a spectrum of finance, commerce and industry.

The Mitsubishi brand name is recognized around the world as a symbol of premium quality.

Mitsubishi Electric Corporation is active in space development, transportation, semi-conductors, energy systems, communications and information processing, audio visual equipment and home electronics, building and energy management and automation systems, and has 237 factories and laboratories worldwide in over 121 countries.

This is why you can rely on Mitsubishi Electric automation solution - because we know first hand about the need for reliable, efficient, easy-to-use automation and control in our own factories.

As one of the world's leading companies with a global turnover of over 4 trillion Yen (over \$40 billion), employing over 100,000 people, Mitsubishi Electric has the resource and the commitment to deliver the ultimate in service and support as well as the best products.



Low voltage: MCCB, MCB, ACB



Medium voltage: VCB, VCC



Power monitoring, energy management



Compact and Modular Controllers



Inverters, Servos and Motors



Visualization: HMIs, Software, MES connectivity



Numerical Control (NC)



Robots: SCARA, Articulated arm



Processing machines: EDM, Lasers, IDS



Air-conditioning, Photovoltaic, EDS

# Global Partner. Local Friend.

## European Offices

<b>Germany</b> <b>Mitsubishi Electric Europe B.V.</b> Mitsubishi-Electric-Platz 1 D-40882 Ratingen Phone: +49 (0)2102 / 486-0	<b>Czech Rep.</b> <b>Mitsubishi Electric Europe B.V.</b> Radlická 751 / I 13e Avenir Business Park CZ-158 00 Praha 5 Phone: +420 251 551 470	<b>France</b> <b>Mitsubishi Electric Europe B.V.</b> 25, Boulevard des Bouvets F-92741 Nanterre Cedex Phone: +33 (0)1 / 55 68 55 68	<b>Ireland</b> <b>Mitsubishi Electric Europe B.V.</b> Westgate Business Park, Ballymount IRL-Dublin 24 Phone: +353 (0)1 4198800	<b>Italy</b> <b>Mitsubishi Electric Europe B.V.</b> Viale Colleoni / Palazzo Smaio I-20064 Agrate Brianza (MB) Phone: +39 039 / 60 53 1	<b>Netherlands</b> <b>Mitsubishi Electric Europe B.V.</b> Nijverheidsweg 23C NL-3641RP Mijdrecht Phone: +31 (0) 297 250 350	<b>Poland</b> <b>Mitsubishi Electric Europe B.V.</b> ul. Krakowska 50 PL-32-083 Balice Phone: +48 (0) 12 347 65 00
<b>Russia</b> <b>Mitsubishi Electric (Russia) LLC</b> 52, bld. 1 Kosmodamianskaya emb. RU-115054 Moscow Phone: +7 495 / 721 2070	<b>Spain</b> <b>Mitsubishi Electric Europe B.V.</b> Carretera de Rubí 76-80 Apdo. 420 E-08190 Sant Cugat del Valles (Barcelona) Phone: +34 (0) 93 / 5653131	<b>Sweden</b> <b>Mitsubishi Electric Europe B.V.</b> (Scandinavia) Fjellievägen 8 SE-22736 Lund Phone: +46 (0) 8 625 10 00	<b>Turkey</b> <b>Mitsubishi Electric Turkey Elektrik Ürünleri A.Ş.</b> Serfali Mahallesi Nutuk Sokak No:5 TR-34775 Ümraniye-İSTANBUL Phone: +90 (216) 969 25 00	<b>UK</b> <b>Mitsubishi Electric Europe B.V.</b> Travellers Lane UK-Hatfield, Herts. AL10 8XB Phone: +44 (0)1707 / 28 87 80	<b>UAE</b> <b>Mitsubishi Electric Europe B.V.</b> Dubai Silicon Oasis United Arab Emirates - Dubai Phone: +971 4 3724716	

## Representatives

<b>Austria</b> <b>GEVA</b> Wiener Straße 99 A-2500 Baden Phone: +43 (0)2252 / 85 55 20	<b>Belarus</b> <b>OOO TECHNIKON</b> Prospect Nezavisimosti 177-9 BY-220125 Minsk Phone: +375 (0)17 / 393 1177	<b>Bosnia and Herzegovina</b> <b>INEA RBT d.o.o.</b> Stegne 11 SI-1000 Ljubljana Phone: +386 (0)1 / 513 8116	<b>Bulgaria</b> <b>AKHNATON</b> 4, Andrei Ljapchev Blvd., PO Box 21 BG-1756 Sofia Phone: +359 (0)2 / 817 6000	<b>Croatia</b> <b>INEA CR</b> Losinjska 4-a HR-10000 Zagreb Phone: +385 (0)1 / 36 940 -01/-02/-03	<b>Czech Republic</b> <b>AutoCont C.S. S.R.O.</b> Kaňkova 1653/3 CZ-702 00 Ostrava 2 Phone: +420 595 691 150	<b>Denmark</b> <b>HANS FØLSTGAARD A/S</b> Theilgaardsgade Torv 1 DK-4600 Køge Phone: +45 4320 8600
<b>Estonia</b> <b>Electrobitt OÜ</b> Pärnu mnt. 160i EST-11317, Tallinn Phone: +372 6518 140	<b>Finland</b> <b>UTU Automation Oy</b> Pelloteite 37 FIN-28400 Ulvila Phone: +358 (0)207 / 463 500	<b>Greece</b> <b>UTECO A.B.E.E.</b> S. Mavrogenous Str. GR-18542 Piraeus Phone: +30 (0)211 / 1206-900	<b>Hungary</b> <b>MELTRADE Kft.</b> Fentő utca 14. HU-1107 Budapest Phone: +36 (0)1 / 431-9726	<b>Kazakhstan</b> <b>TOO Kazpromavtomatika</b> Ul. Shantyl'sya 29 KAZ-100017 Karaganda Phone: +7 7212 / 50 10 00	<b>Latvia</b> <b>OAK Integrator Products SIA</b> Rītausmas iela 23 LV-1058 Rīga Phone: +371 67842280	<b>Lithuania</b> <b>Automatikos Centras, UAB</b> Neries krantinė: 14A-101 LT-48397 Kaunas Phone: +370 37 262707
<b>Malta</b> <b>ALFATRADE Ltd.</b> 99, Paola Hill Malta-Paola PLA. 1702 Phone: +356 (0)21 / 697 816	<b>Moldova</b> <b>INTEHSES SRL</b> bld. Traian 23/1 MD-2060 Kishinev Phone: +373 (0)22 / 66 4242	<b>Portugal</b> <b>Fonseca S.A.</b> R. João Francisco do Casal 87/89 PT-3801-997 Aveiro, Esigueira Phone: +351 (0)234 / 303 900	<b>Romania</b> <b>Sirius Trading &amp; Services</b> Aleea Lacul Morii Nr. 3 RO-060841 Bucuresti, Sector 6 Phone: +40 (0)21 / 430 40 05	<b>Serbia</b> <b>INEA SR d.o.o.</b> Ul. Karadjordjeva 12/217 SER-11300 Smederevo Phone: +386 (026) 461 54 01	<b>Slovakia</b> <b>SIMAP SK</b> Dolná Pažte 603/97 SK-911 06 Trenčín Phone: +421 (0)32 743 04 72	<b>Slovenia</b> <b>INEA RBT d.o.o.</b> Stegne 11 SI-1000 Ljubljana Phone: +386 (0)1 / 513 8116
<b>Switzerland</b> <b>OMNI RAY AG</b> Im Schörlis 5 CH-8600 Dübendorf Phone: +41 (0)44 / 802 28 80	<b>Ukraine</b> <b>CSC- AUTOMATION Ltd.</b> 4 B. Yevhena Sverstyuka Str. UA-02002 Kiev Phone: +380 (0)44 / 494 33 44					
<b>Israel</b> <b>GIRIT CELADON Ltd.</b> 12 Haomanut Street IL-42502 Netanya Phone: +972 (0)9 / 863 39 80	<b>Israel</b> <b>ILAN &amp; GAVISH Ltd.</b> 24 Shenkar St. Kiryat Arie IL-49001 Petah Tikva Phone: +972 (0)3 / 922 18 24	<b>Lebanon</b> <b>CEG LIBAN</b> Cebaco Center/Block A Autostade DORRA Lebanon-Beirut Phone: +961 (0)1 / 240 445	<b>South Africa</b> <b>ADROIT TECHNOLOGIES</b> 20 Waterford Office Park 189 Witkoppen Road ZA-Fourways Phone: +27 (0)11 / 658 8100			

Version check



Art. no. 260570-C

## Mitsubishi Electric Europe B.V.

FA - European Business Group  
 Mitsubishi-Electric-Platz 1  
 D-40882 Ratingen Germany  
 Tel.: +49(0)2102-4860 Fax: +49(0)2102-4861120  
 info@mitsubishi-automation.com  
 https://eu3a.mitsubishielectric.com

Specifications subject to change. All trademarks and copyrights acknowledged.

Printed April 2017